

CK45 AL SERİSİ

Alüminyum Açık Çıta

CK45 AL SERIE

Aluminium Open Frame

CK45 ALY SERİSİ

Alüminyum Yarı Kapalı Kapak

CK45 ALY SERIE

Aluminium Half Covered

CK45 ALK SERİSİ

Alüminyum Kapalı Kapak

CK45 ALK SERIE

Aluminium Closed Cover

CK45 B SERİSİ

Özel İşlemeli Alüminyum

CK45 B SERIE

Special Designed Aluminium

MALZEME ÖZELLİKLERİ

MATERIAL FEATURES

PA6 %30 Cam Elyaf | PA6 With %30 Fiber Glass

MAKSİMUM ÇALIŞMA MESAFESİ

MAX TRAVEL DISTANCE

120 metre | 120 meter

HIZ

MAX SPEED

4 m/sn | 4 m/sec

ÇALIŞMA SICAKLIĞI

OPERATING TEMPERATURE

-30 °C ~ + 130 °C

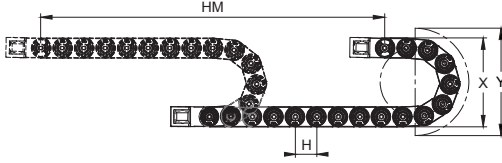

- L** Kullanılacak Miktar
Calculation of the Chain Length
- HM** Hareket Mesafesi
Movement Distance
- X** Montaj Yüksekliği
Mounting Height
- Y** Radyüs Mesafesi
Radius Distance
- H** Hatve
Pitch

$$L = HM / 2 + Y$$

$$X = R \times 2 + C$$

$$Y = R \times \pi$$

Kıvrılma Yarıçapı / Bending Radius	75	100	150	200	250	300	450
H (mm)	85	85	85	85	85	85	85
X (mm)	215	265	365	465	565	665	965
Y (mm)	236	314	471	628	785	942	1413

YÜK DİYAGRAMI LOAD DIAGRAM

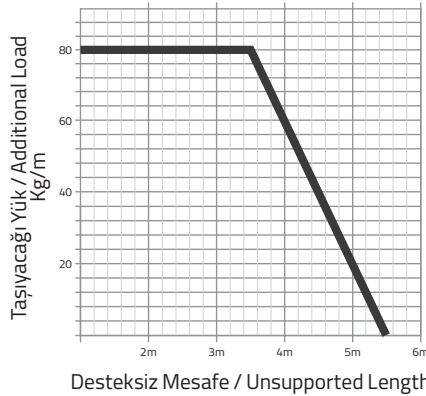

CK45 AL SERİSİ

CK45 AL SERIE

İçten ve Dıştan Civatalı Alüminyum Çıta
Bolted Inside and Outside Aluminium Frame

Örnek Ürün Kodu
Product No. Example

CK45

İç Yükseklik
Inner Height

AL

Alüminyum Çıta
Aluminium Frame

250

İç Genişlik
Inner Width

R200

Kıvrılma Yarıçapı
Bending Radius

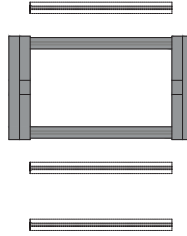
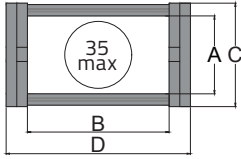

CK45 AL	A	B _{min} - B _{max}	C	D _{min} - D _{max}	R
MODEL	İç Yükseklik (mm) Inner Height (mm)	İç Genişlik (mm) Inner Width (mm)	Dış Yükseklik (mm) Outer Height (mm)	Dış Genişlik (mm) Outer Width (mm)	Kıvrılma Yarıçapı Bending Radius
CK45 AL	45	80-600	65	118-638	75, 100, 150, 200, 250, 300, 450

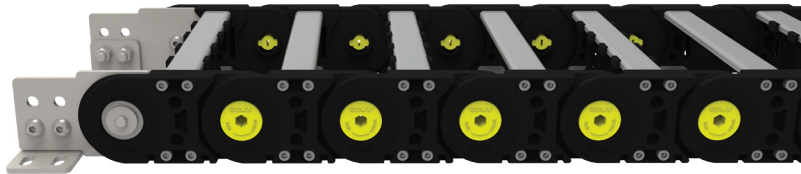

CK45 ALY SERİSİ

CK45 ALY SERIE

İçten Cıvatalı Alüminyum Çıta
Dıştan Cıvatalı Alüminyum Kapak

Bolted Inside Aluminium Frame and Bolted Outside
Aluminium Cover

Örnek Ürün Kodu
Product No. Example

CK45

İç Yükseklik
Inner Height

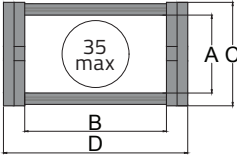

ALY

Yarı Açık Seri
Half Covered Serie

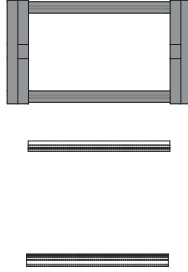

400

İç Genişlik
Inner Width

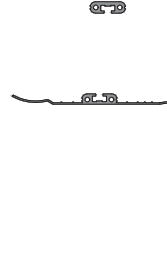

R300

Kıvrılma Yarıçapı
Bending Radius

CK45 ALY	A	B _{min} - B _{max}	C	D _{min} - D _{max}	R
MODEL	İç Yükseklik (mm) Inner Height (mm)	İç Genişlik (mm) Inner Width (mm)	Dış Yükseklik (mm) Outer Height (mm)	Dış Genişlik (mm) Outer Width (mm)	Kıvrılma Yarıçapı Bending Radius
CK45 ALY	45	80-600	65	118-638	200, 250, 300, 450



CK45 ALK SERİSİ

CK45 ALK SERIE

İçten ve Dıştan Civatalı
Alüminyum Kapak
Bolted Inside and Outside Aluminium Cover

Örnek Ürün Kodu
Product No. Example

CK45

İç Yükseklik
Inner Height

ALK

Kapalı Seri
Closed Cover

250

İç Genişlik
Inner Width

R200

Kıvrılma Yarıçapı
Bending Radius

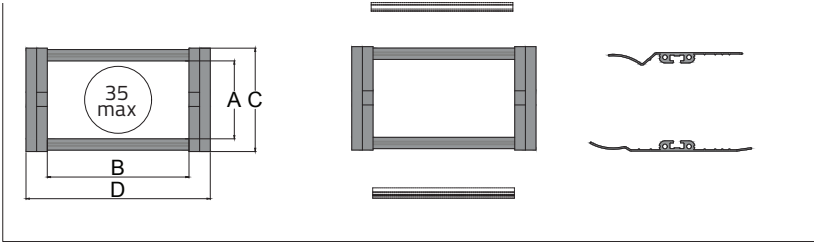

CK45 ALK	A	B _{min} - B _{max}	C	D _{min} - D _{max}	R
MODEL	İç Yükseklik (mm) Inner Height (mm)	İç Genişlik (mm) Inner Width (mm)	Dış Yükseklik (mm) Outer Height (mm)	Dış Genişlik (mm) Outer Width (mm)	Kıvrılma Yarıçapı Bending Radius
CK45 ALK	45	80-600	65	118-638	200, 250, 300, 450

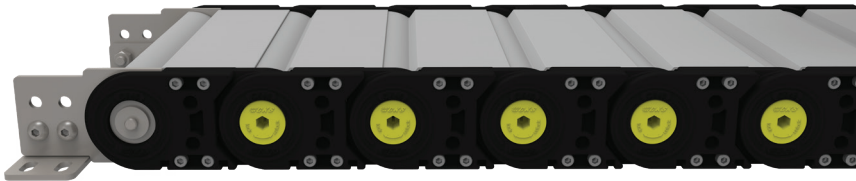

CK45 B SERİSİ

CK45 B SERIE

Özel İşlemeli Alüminyum Lama
Special Design Aluminium Bar

Örnek Ürün Kodu
Product No. Example

CK45

İç Yükseklik
Inner Height

B

Özel İşlemeli
Special Designed

400

İç Genişlik
Inner Width

R300

Kıvrılma Yarıçapı
Bending Radius

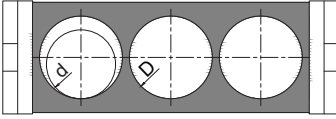

D_{max} 40 mm

Yatay ve Dikey Uzanan Delikli Alüminyum Lama
Hole Stay With Horizontal and Vertical Elongated Holes

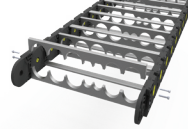
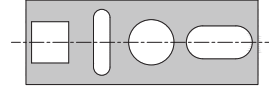

- Kablo ve hortum ölçülerine göre özel imalat edilebilir / Available special design for your cable and hose holes

CK45 B	A	B _{min} - B _{max}	C	D _{min} - D _{max}	R
MODEL	İç Yükseklik (mm) Inner Height (mm)	İç Genişlik (mm) Inner Width (mm)	Dış Yükseklik (mm) Outer Height (mm)	Dış Genişlik (mm) Outer Width (mm)	Kıvrılma Yarıçapı Bending Radius
CK45 B	-	80-600	65	118-638	75, 100, 150, 200, 250, 300, 450

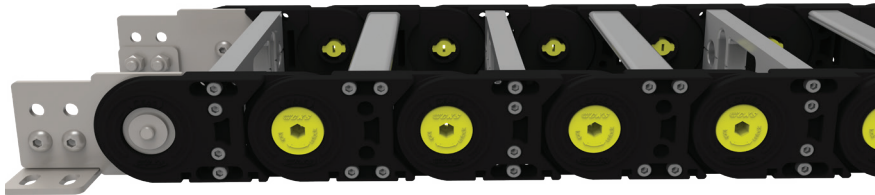

CK45.1 SERİSİ

CK45.1SERIE

**İçten ve Dıştan Kolay
Açılabilir Alüminyum Çıta**
*Detachable Aluminium Frame From
Inside and Outside*

Örnek Ürün Kodu
Product No. Example

CK45

İç Yükseklik
Inner Height

.1

Kolay Açılabilir
Alüminyum Çıta
Detachable
Aluminium Frame

250

İç Genişlik
Inner Width

R200

Kıvrılma Yarıçapı
Bending Radius

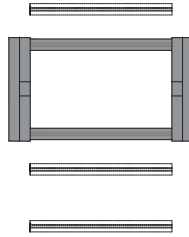
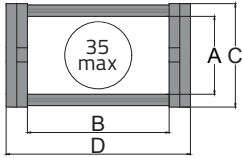

CK45 AL	A	B _{min} - B _{max}	C	D _{min} - D _{max}	R
MODEL	İç Yükseklik (mm) Inner Height (mm)	İç Genişlik (mm) Inner Width (mm)	Dış Yükseklik (mm) Outer Height (mm)	Dış Genişlik (mm) Outer Width (mm)	Kıvrılma Yarıçapı Bending Radius
CK45 AL	45	80-600	65	118-638	75, 100, 150, 200, 250, 300, 450



CK45.2 SERİSİ

CK45.2SERIE

İçten Civatalı Alüminyum Çıta
Dıştan Kolay Açılabilir Alüminyum Çıta
Bolted Aluminium Frame From Inside and
Detachable Aluminium Frame From Outside



CK45.3 SERİSİ

CK45.3SERIE

İçten Kolay Açılabilir Alüminyum Çıta
Dıştan Civatalı Alüminyum Çıta
Detachable Aluminium Frame From Inside and
Bolted Aluminium Frame From Outside

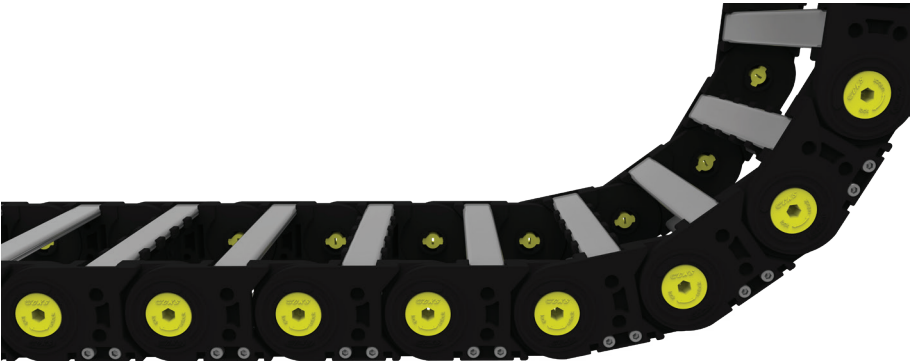

CK45.4 SERİSİ

CK45.4SERIE

Civatalı İnce Çıta
Bolted Stick



CK45.5 SERİSİ

CK45.5SERIE

Civatalı Alüminyum İnce ve Kalın Çıta
Bolted Aluminium Stick and Frame

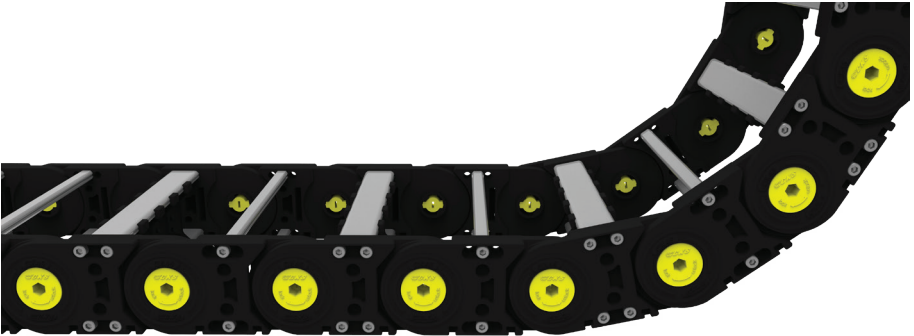

Metal Ayak Montaj Ölçüleri

Metal End Bracket Assembly Dimensions

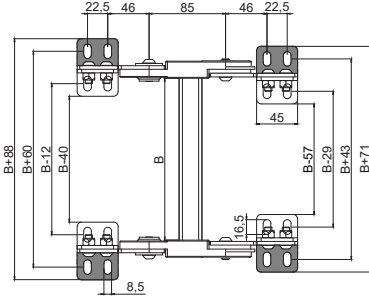

'B' ölçüsünü ölçü tablosundan bulabilirsiniz.
You will find the 'B' dimension from model table.

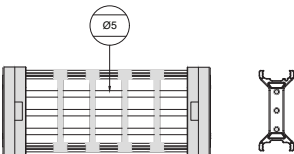
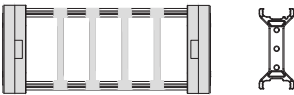
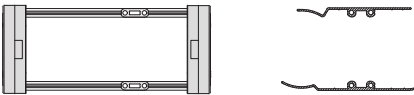
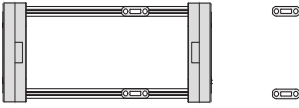

CK45 M

CK45 AL



CK45 ALK



CK45 ALY

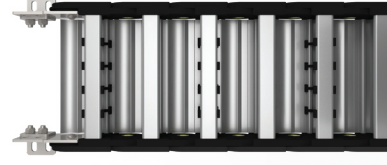

CK45 B



CK45 SP



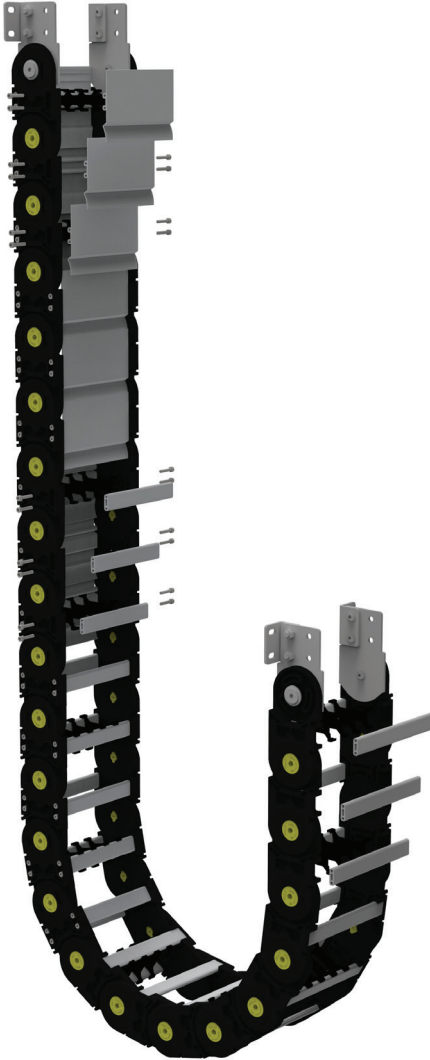

CK62 AL SERİSİ

Alüminyum Açık Çıta

CK62 AL SERIE

Aluminium Open Frame

CK62 ALY SERİSİ

Alüminyum Yarı Kapalı Kapak

CK62 ALY SERIE

Aluminium Half Covered

CK62 ALK SERİSİ

Alüminyum Kapalı Kapak

CK62 ALK SERIE

Aluminium Closed Cover

CK62 B SERİSİ

Özel İşlemeli Alüminyum

CK62 B SERIE

Special Designed Aluminium

MALZEME ÖZELLİKLERİ

MATERIAL FEATURES

PA6 %30 Cam Elyaf | PA6 With %30 Fiber Glass

MAKSİMUM ÇALIŞMA MESAFESİ

MAX TRAVEL DISTANCE

120 metre | 120 meter

HIZ

MAX SPEED

4 m/sn | 4 m/sec

ÇALIŞMA SICAKLIĞI

OPERATING TEMPERATURE

-30°C ~ + 130°C

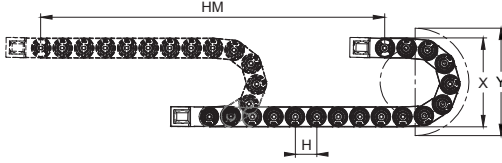

- L** Kullanılacak Miktar
Calculation of the Chain Length
- HM** Hareket Mesafesi
Movement Distance
- X** Montaj Yüksekliği
Mounting Height
- Y** Radyüs Mesafesi
Radius Distance
- H** Hatve
Pitch

$$L = HM / 2 + Y$$

$$X = R \times 2 + C$$

$$Y = R \times \pi$$

Kıvrılma Yarıçapı / Bending Radius	100	150	200	250	300	350	450
H (mm)	100	100	100	100	100	100	100
X (mm)	282	382	482	582	682	782	982
Y (mm)	314	471	628	785	942	1099	1413

YÜK DİYAGRAMI LOAD DIAGRAM

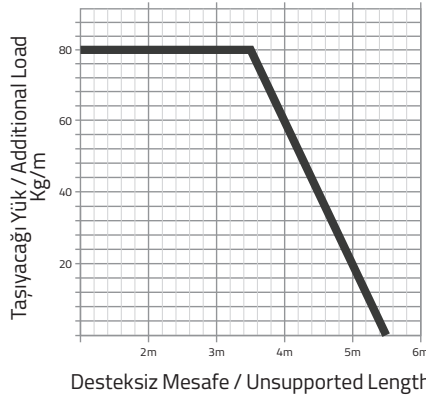

CK62 AL SERİSİ

CK62 AL SERIE

İçten ve Dıştan Civatalı Alüminyum Çıta
Bolted Inside and Outside Aluminium Frame

Örnek Ürün Kodu
Product No. Example

CK62

İç Yükseklik
Inner Height

AL

Alüminyum Çıta
Aluminium Frame

250

İç Genişlik
Inner Width

R200

Kıvrılma Yarıçapı
Bending Radius

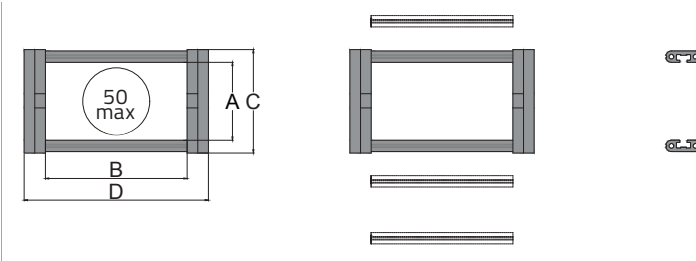

CK62 AL	A	B _{min} - B _{max}	C	D _{min} - D _{max}	R
MODEL	İç Yükseklik (mm) Inner Height (mm)	İç Genişlik (mm) Inner Width (mm)	Dış Yükseklik (mm) Outer Height (mm)	Dış Genişlik (mm) Outer Width (mm)	Kıvrılma Yarıçapı Bending Radius
CK62 AL	60	80-600	82	123-643	100, 150, 200, 250, 300, 350, 450



CK62 ALY SERİSİ

CK62 ALY SERIE

İçten Civatalı Alüminyum Çita
Dıştan Civatalı Alüminyum Kapak
Bolted Inside Aluminium Frame and Bolted
Outside Aluminium Cover

Örnek Ürün Kodu
Product No. Example

CK62

İç Yükseklik
Inner Height

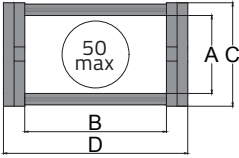

ALY

Yarı Açık Seri
Half Coverd Serie

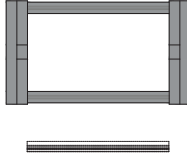

400

İç Genişlik
Inner Width

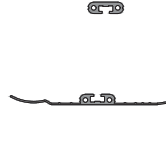

R300

Kıvrılma Yarıçapı
Bending Radius

CK62 ALY	A	B _{min} - B _{max}	C	D _{min} - D _{max}	R
MODEL	İç Yükseklik (mm) Inner Height (mm)	İç Genişlik (mm) Inner Width (mm)	Dış Yükseklik (mm) Outer Height (mm)	Dış Genişlik (mm) Outer Width (mm)	Kıvrılma Yarıçapı Bending Radius
CK62 ALY	60	80-600	82	123-643	200, 250, 300, 350, 450



CK62 ALK SERİSİ

CK62 ALK SERIE

İçten ve Dıştan Cıvatalı
Alüminyum Kapak
Bolted Inside and Outside
Aluminium Cover

Örnek Ürün Kodu
Product No. Example

CK62

İç Yükseklik
Inner Height

ALK

Kapalı Seri
Closed Cover

250

İç Genişlik
Inner Width

R200

Kıvrılma Yarıçapı
Bending Radius

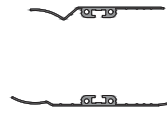
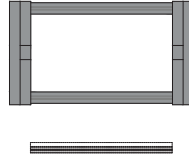
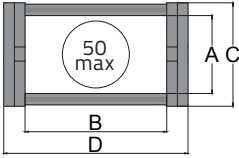

CK62 ALK	A	B _{min} - B _{max}	C	D _{min} - D _{max}	R
MODEL	İç Yükseklik (mm) Inner Height (mm)	İç Genişlik (mm) Inner Width (mm)	Dış Yükseklik (mm) Outer Height (mm)	Dış Genişlik (mm) Outer Width (mm)	Kıvrılma Yarıçapı Bending Radius
CK62 ALK	60	80-600	82	123-643	200, 250, 300, 350, 450



CK62 B SERİSİ

CK62 B SERIE

Özel İşlemeli Alüminyum Lama
Special Design Aluminium Bar

Örnek Ürün Kodu
Product No. Example

CK62

İç Yükseklik
Inner Height

B

Özel İşlemeli
Special Designed

400

İç Genişlik
Inner Width

R300

Kıvrılma Yarıçapı
Bending Radius

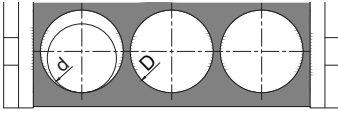

D_{max} 50 mm

Yatay ve Dikey Uzanan Delikli Alüminyum Lama
Hole Stay With Horizontal and Vertical Elongated Holes

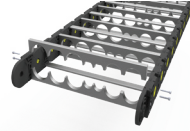
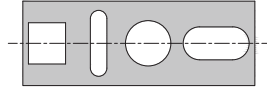

- Kablo ve hortum ölçülerine göre özel imalat edilebilir / Available special design for your cable and hose holes

CK62 B	A	$B_{min} - B_{max}$	C	$D_{min} - D_{max}$	R
MODEL	İç Yükseklik (mm) Inner Height (mm)	İç Genişlik (mm) Inner Width (mm)	Diş Yükseklik (mm) Outer Height (mm)	Diş Genişlik (mm) Outer Width (mm)	Kıvrılma Yarıçapı Bending Radius
CK62 B	-	80-600	82	123-643	100, 150, 200, 250, 300, 350, 450



CK62.1 SERİSİ

CK62.1SERIE

**İçten ve Dıştan Kolay
Açılabilir Alüminyum Çıta**
Detachable Aluminium Frame From
Inside and Outside

Örnek Ürün Kodu
Product No. Example

CK62

İç Yükseklik
Inner Height

.1

Kolay Açılabilir
Alüminyum Çıta
Detachable
Aluminium Frame

250

İç Genişlik
Inner Width

R200

Kıvrılma Yarıçapı
Bending Radius

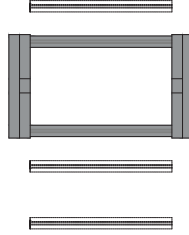
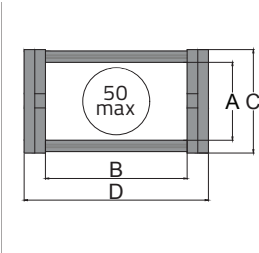

CK62.1	A	B _{min} - B _{max}	C	D _{min} - D _{max}	R
MODEL	İç Yükseklik (mm) Inner Height (mm)	İç Genişlik (mm) Inner Width (mm)	Dış Yükseklik (mm) Outer Height (mm)	Dış Genişlik (mm) Outer Width (mm)	Kıvrılma Yarıçapı Bending Radius
CK62.1	60	80-600	82	123-643	100, 150, 200, 250, 300, 350, 450



CK62.2 SERİSİ

CK62.2SERIE

İçten Civatalı Alüminyum Çıta
Dıştan Kolay Açılabilir Alüminyum Çıta
Bolted Aluminium Frame From Inside and
Detachable Aluminium Frame From Outside



CK62.3 SERİSİ

CK62.3SERIE

İçten Kolay Açılabilir Alüminyum Çıta
Dıştan Civatalı Alüminyum Çıta
Detachable Aluminium Frame From Inside and
Bolted Aluminium frame from Outside



CK62.4 SERİSİ

CK62.4SERIE

Civatalı İnce Çıta
Bolted Stick



CK62.5 SERİSİ

CK62.5SERIE

Civatalı Alüminyum İnce ve Kalın Çıta
Bolted Aluminium Stick and Frame

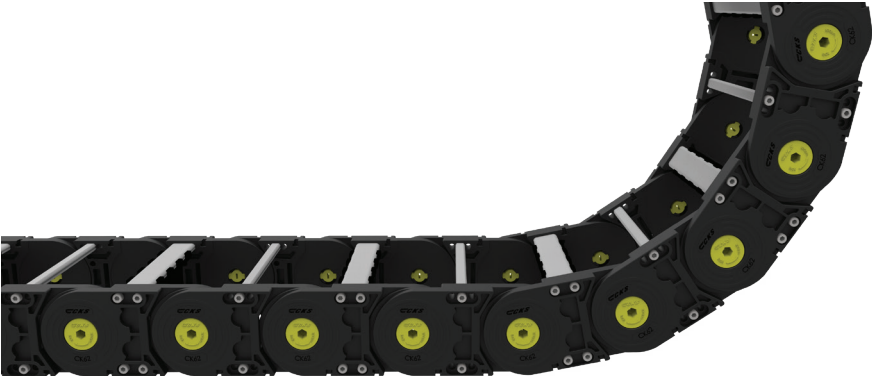

Metal Ayak Montaj Ölçüleri

Metal End Bracket Assembly Dimensions

CK62 M

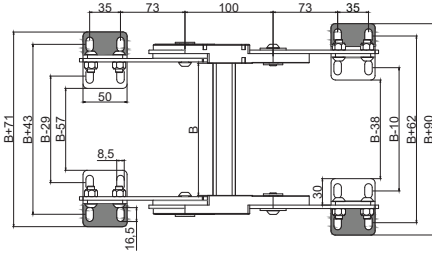

'B' ölçüsünü ölçü tablosundan bulabilirsiniz.
You will find the 'B' dimension from model table.

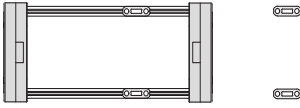

CK62 AL

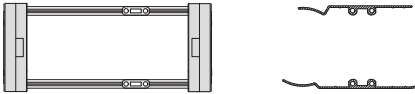
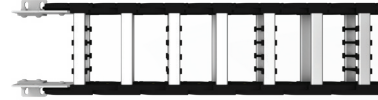

CK62 ALK

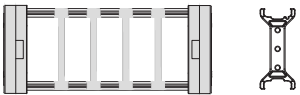

CK62 ALY

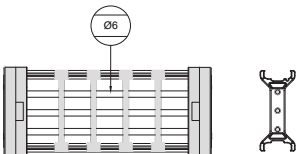
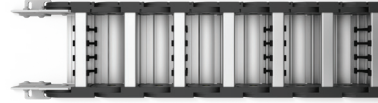

CK62 B



CK62 SP



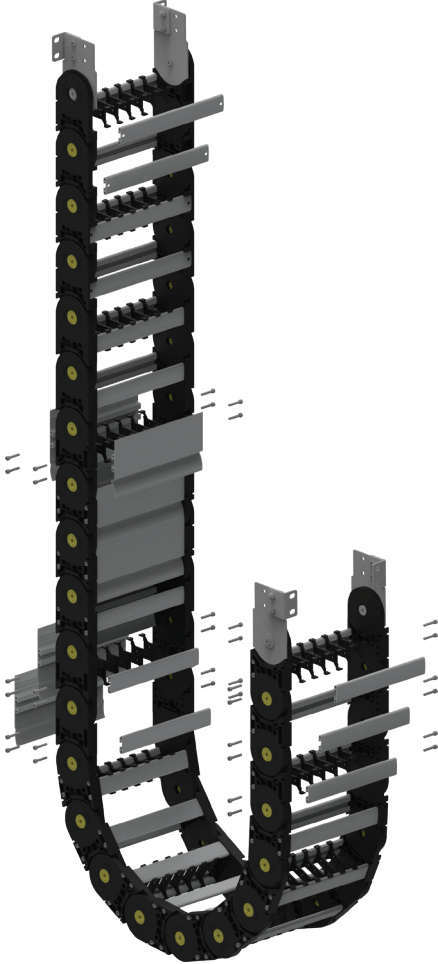

CK75 AL SERİSİ

Alüminyum Açık Çıta

CK75 AL SERIE

Aluminium Open Frame

CK75 ALY SERİSİ

Alüminyum Yarı Kapalı Kapak

CK75 ALY SERIE

Aluminium Half Covered

CK75 ALK SERİSİ

Alüminyum Kapalı Kapak

CK75 ALK SERIE

Aluminium Closed Cover

CK75 B SERİSİ

Özel İşlemeli Alüminyum

CK75 B SERIE

Special Designed Aluminium

MALZEME ÖZELLİKLERİ

MATERIAL FEATURES

PA6 %30 Cam Elyaf | PA6 With %30 Fiber Glass

MAKSİMUM ÇALIŞMA MESAFESİ

MAX TRAVEL DISTANCE

120 metre | 120 meter

HIZ

MAX SPEED

4 m/sn | 4 m/sec

ÇALIŞMA SICAKLIĞI

OPERATING TEMPERATURE

-30°C ~ + 130°C

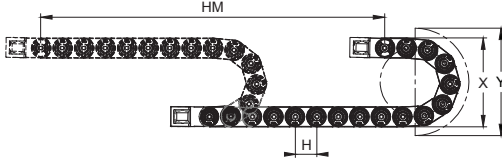

- L** Kullanılacak Miktar
Calculation of the Chain Length
- HM** Hareket Mesafesi
Movement Distance
- X** Montaj Yüksekliği
Mounting Height
- Y** Radüs Mesafesi
Radius Distance
- H** Hatve
Pitch

$$L = HM / 2 + Y$$

$$X = R \times 2 + C$$

$$Y = R \times \pi$$

Kıvrılma Yarıçapı / Bending Radius	150	200	250	300	350
H (mm)	125	125	125	125	125
X (mm)	402	502	602	702	802
Y (mm)	471	628	785	942	1099

YÜK DİYAGRAMI LOAD DIAGRAM

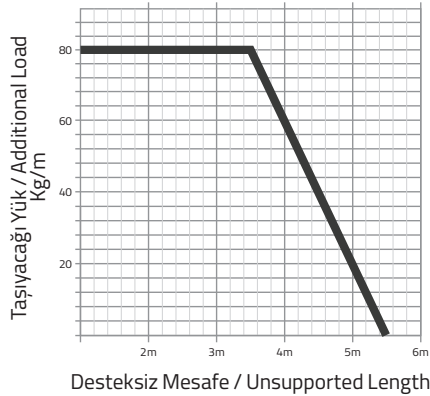

CK75 AL SERİSİ

CK75 AL SERIE

İçten ve Dıştan Cıvatalı Alüminyum Çıta
Bolted Inside and Outside Aluminium Frame

Örnek Ürün Kodu
Product No. Example

CK75

İç Yükseklik
Inner Height

AL

Alüminyum Çıta
Aluminium Frame

250

İç Genişlik
Inner Width

R200

Kıvrılma Yarıçapı
Bending Radius

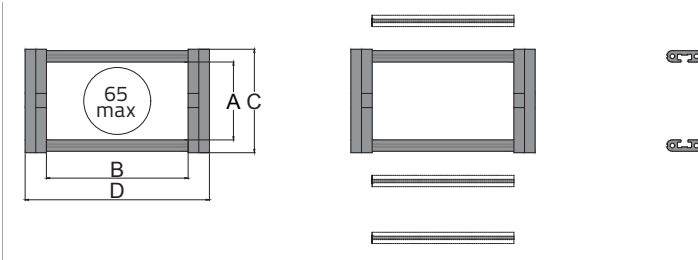

CK75 AL	A	B _{min} - B _{max}	C	D _{min} - D _{max}	R
MODEL	İç Yükseklik (mm) Inner Height (mm)	İç Genişlik (mm) Inner Width (mm)	Dış Yükseklik (mm) Outer Height (mm)	Dış Genişlik (mm) Outer Width (mm)	Kıvrılma Yarıçapı Bending Radius
CK75 AL	75	100-800	102	143-843	150, 200, 250, 300, 350, 450



CK75 ALY SERİSİ

CK75 ALY SERIE

İçten Civatalı Alüminyum Çita
Dıştan Civatalı Alüminyum Kapak
Bolted Inside Aluminium Frame and Bolted
Outside Aluminium Cover

Örnek Ürün Kodu
Product No. Example

CK75

İç Yükseklik
Inner Height

ALY

Yarı Açık Seri
Half Covered Serie

400

İç Genişlik
Inner Width

R300

Kıvrılma Yarıçapı
Bending Radius

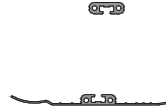
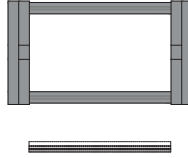
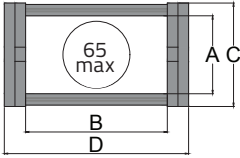

CK75 ALY	A	B _{min} - B _{max}	C	D _{min} - D _{max}	R
MODEL	İç Yükseklik (mm) Inner Height (mm)	İç Genişlik (mm) Inner Width (mm)	Dış Yükseklik (mm) Outer Height (mm)	Dış Genişlik (mm) Outer Width (mm)	Kıvrılma Yarıçapı Bending Radius
CK75 ALY	75	100-800	102	143-843	200, 250, 300, 350, 450

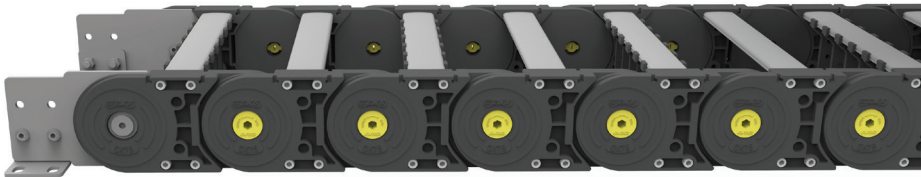

CK75 ALK SERİSİ

CK75 ALK SERIE

İçten ve Dıştan Civatalı
Alüminyum Kapak

Bolted Inside and Outside Aluminium Cover

Örnek Ürün Kodu
Product No. Example

CK75

İç Yükseklik
Inner Height

ALK

Kapalı Seri
Closed Cover

250

İç Genişlik
Inner Width

R200

Kıvrılma Yarıçapı
Bending Radius

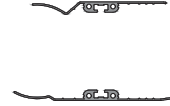
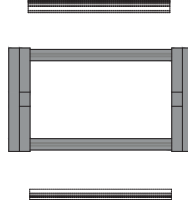
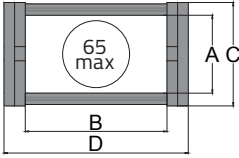

CK75 ALK	A	B _{min} - B _{max}	C	D _{min} - D _{max}	R
MODEL	İç Yükseklik (mm) Inner Height (mm)	İç Genişlik (mm) Inner Width (mm)	Dış Yükseklik (mm) Outer Height (mm)	Dış Genişlik (mm) Outer Width (mm)	Kıvrılma Yarıçapı Bending Radius
CK75 ALK	75	100-800	102	143-843	200, 250, 300, 350, 450

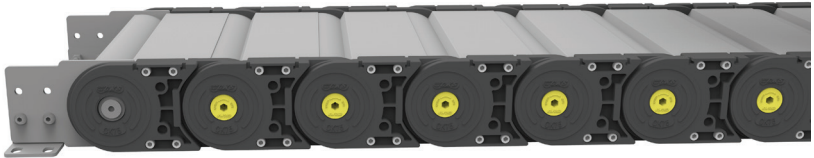

CK75 B SERİSİ

CK75 B SERIE

Özel İşlemeli Alüminyum Lama
Special Design Aluminium Bar

Örnek Ürün Kodu
Product No. Example

CK75

İç Yükseklik
Inner Height

B

Özel İşlemeli
Special Designed

400

İç Genişlik
Inner Width

R300

Kıvrılma Yarıçapı
Bending Radius

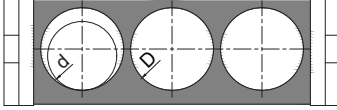

D_{max} 70 mm

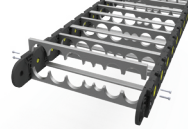
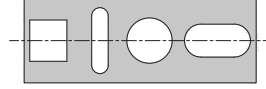

Yatay ve Dikey Uzanan Delikli Alüminyum Lama
Hole Stay With Horizontal and Vertical Elongated Holes

- Kablo ve hortum ölçülerine göre özel imalat edilebilir / Available special design for your cable and hose holes

CK75 B	A	B _{min} - B _{max}	C	D _{min} - D _{max}	R
MODEL	İç Yükseklik (mm) Inner Height (mm)	İç Genişlik (mm) Inner Width (mm)	Diş Yükseklik (mm) Outer Height (mm)	Diş Genişlik (mm) Outer Width (mm)	Kıvrılma Yarıçapı Bending Radius
CK75 B	-	100-800	102	143-843	150, 200, 250, 300, 350, 450



CK75.1 SERİSİ

CK75.1SERIE

İçten ve Dıştan Kolay Açılabilir
Alüminyum Çıta

Detachable Aluminium Frame From Inside and Outside

Örnek Ürün Kodu
Product No. Example

CK75

İç Yükseklik
Inner Height

.1

Kolay Açılabilir
Alüminyum Çıta
Detachable
Aluminium Frame

250

İç Genişlik
Inner Width

R200

Kıvrılma Yarıçapı
Bending Radius

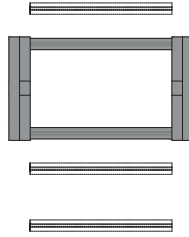
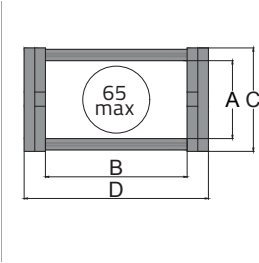

CK75.1	A	B _{min} - B _{max}	C	D _{min} - D _{max}	R
MODEL	İç Yükseklik (mm) Inner Height (mm)	İç Genişlik (mm) Inner Width (mm)	Dış Yükseklik (mm) Outer Height (mm)	Dış Genişlik (mm) Outer Width (mm)	Kıvrılma Yarıçapı Bending Radius
CK75.1	75	100-800	102	143-843	150, 200, 250, 300, 350, 450

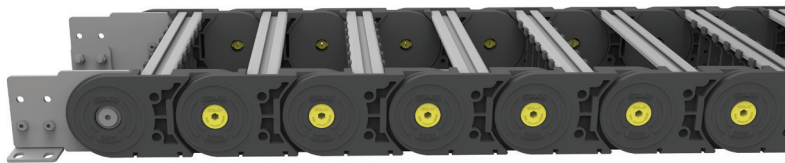

CK75.2 SERİSİ

CK75.2SERIE

İçten Civatalı Alüminyum Çıta
Dıştan Kolay Açılabilir Alüminyum Çıta
Bolted Aluminium Frame From Inside and
Detachable Aluminium Frame From Outside



CK75.3 SERİSİ

CK75.3SERIE

İçten Kolay Açılabilir Alüminyum Çıta
Dıştan Civatalı Alüminyum Çıta
Detachable Aluminium Frame From Inside and
Bolted Aluminium Frame From Outside



Metal Ayak Montaj Ölçüleri
Metal End Bracket Assembly Dimensions

CK75 M

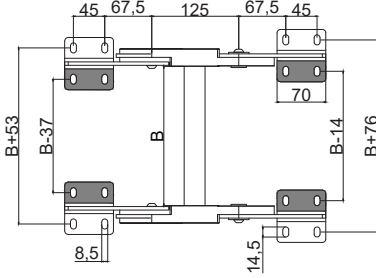

'B' ölçüsünü ölçü tablosundan bulabilirsiniz.
You will find the 'B' dimension from model table.

CK75 AL



CK75 ALK



CK75 ALY

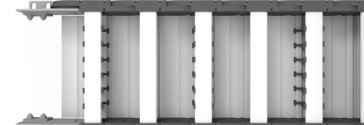

CK75 B

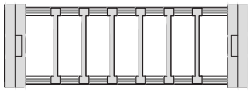
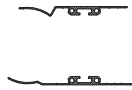
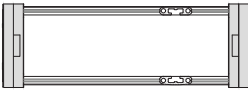
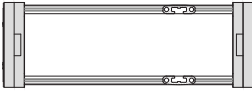

CK75 SP



CK45 - CK62 - CK75 Montaj - Demontaj

CK 45 - CK62 - CK75 Metal End Bracket Assembly and Disassembly

Montaj Assembly

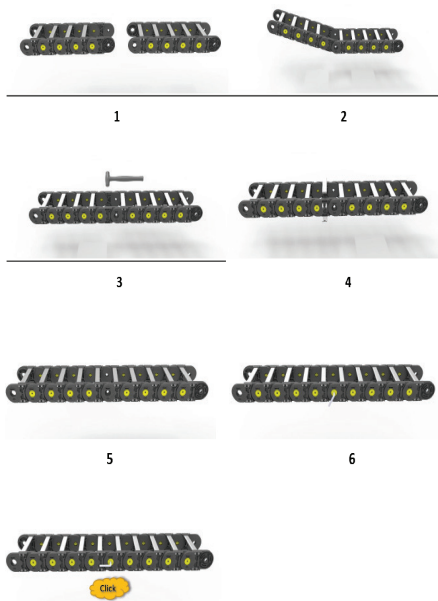

Demontaj Disassembly

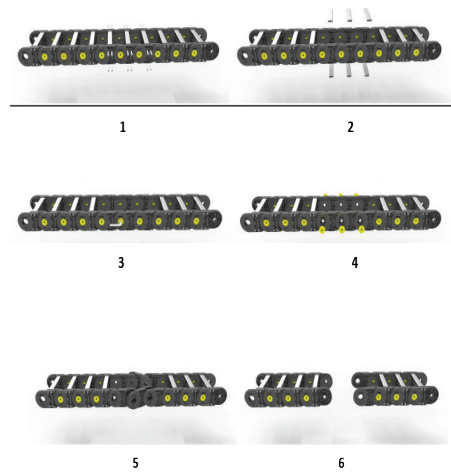

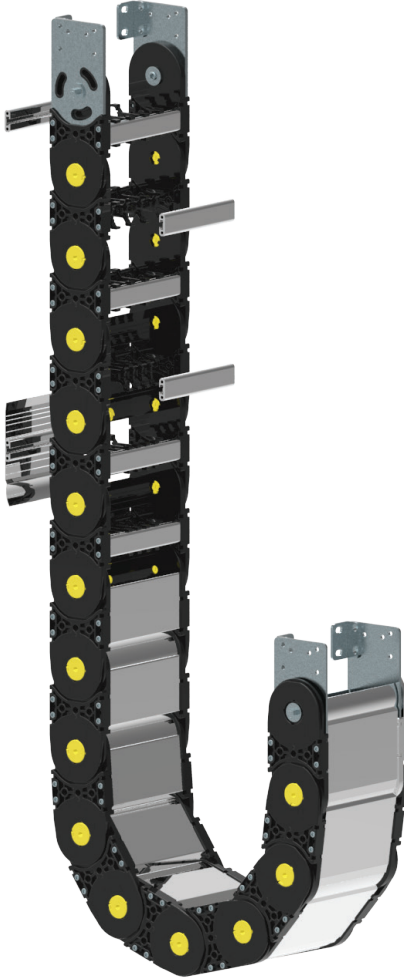

CK110 AL SERİSİ

Alüminyum Açık Çıta

CK110 AL SERIE

Aluminium Open Frame

CK110 ALY SERİSİ

Alüminyum Yarı Kapalı Kapak

CK110 ALY SERIE

Aluminium Half Covered

CK110 ALK SERİSİ

Alüminyum Kapalı Kapak

CK110 ALK SERIE

Aluminium Closed Cover

MALZEME ÖZELLİKLERİ

MATERIAL FEATURES

PA6 %30 Cam Elyaf | PA6 With %30 Fiber Glass

MAKSİMUM ÇALIŞMA MESAFESİ

MAX TRAVEL DISTANCE

120 metre | 120 meter

HIZ

MAX SPEED

4 m/sn | 4 m/sec

ÇALIŞMA SICAKLIĞI

OPERATING TEMPERATURE

-30°C ~ + 130°C

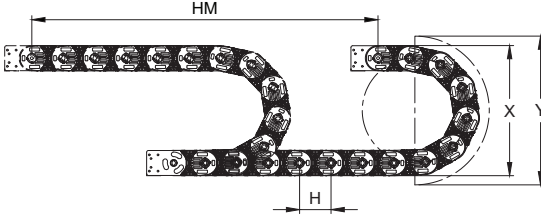

- L** Kullanılacak Miktar
Calculation of the Chain Length
- HM** Hareket Mesafesi
Movement Distance
- X** Montaj Yüksekliği
Mounting Height
- Y** Radüs Mesafesi
Radius Distance
- H** Hatve
Pitch

$$L = HM / 2 + Y$$

$$X = R \times 2 + C$$

$$Y = R \times \pi$$

Kıvrılma Yarıçapı / Bending Radius	200	300	600
H (mm)	180	180	180
X (mm)	545	745	1343
Y (mm)	628	942	1884

YÜK DİYAGRAMI LOAD DIAGRAM

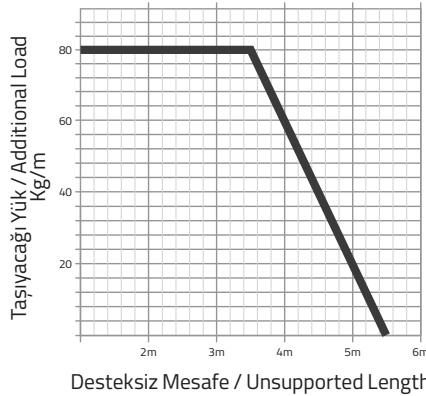

CK110 AL SERİSİ

CK110 AL SERIE

İçten ve Dıştan Açılabilir Çıta
Openable From Inner and Outside

Örnek Ürün Kodu
Product No. Example

CK110

İç Yükseklik
Inner Height

AL

Alimunyum Çıta
Aluminium Frame

250

İç Genişlik
Inner Width

R200

Kıvrılma Yarıçapı
Bending Radius

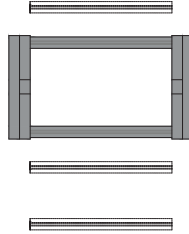
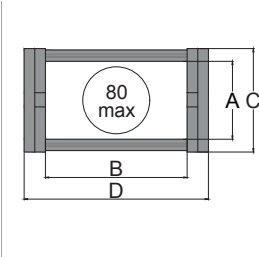

CK110 AL	A	B _{min} - B _{max}	C	D _{min} - D _{max}	R
MODEL	İç Yükseklik (mm) Inner Height (mm)	İç Genişlik (mm) Inner Width (mm)	Dış Yükseklik (mm) Outer Height (mm)	Dış Genişlik (mm) Outer Width (mm)	Kıvrılma Yarıçapı Bending Radius
CK110 AL	110	200-800	145	264-864	200, 300, 600

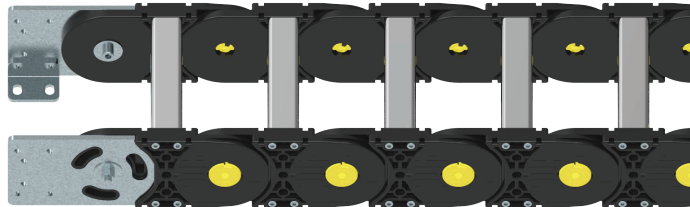

CK110 ALY SERİSİ

CK110 ALY SERIE

İçten ve Dıştan Açılabilir Kapak
Openable From Inner and Outside

Örnek Ürün Kodu
Product No. Example

CK110

İç Yükseklik
Inner Height

ALY

Yarı Açık Seri
Half Coverd Serie

400

İç Genişlik
Inner Width

R300

Kıvrılma Yarıçapı
Bending Radius

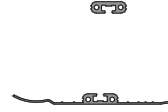
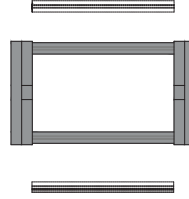
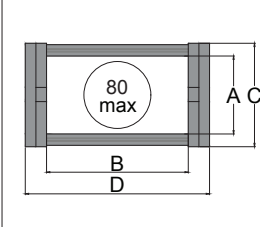

CK110 ALY	A	B _{min} - B _{max}	C	D _{min} - D _{max}	R
MODEL	İç Yükseklik (mm) Inner Height (mm)	İç Genişlik (mm) Inner Width (mm)	Dış Yükseklik (mm) Outer Height (mm)	Dış Genişlik (mm) Outer Width (mm)	Kıvrılma Yarıçapı Bending Radius
CK110 ALY	110	200-800	145	264-864	300, 600



CK110 ALK SERİSİ

CK110 ALK SERIE

İçten ve Dıştan Açılabilir Kapak
Openable From Inner and Outside

Örnek Ürün Kodu
Product No. Example

CK110

İç Yükseklik
Inner Height

ALK

Kapalı Seri
Closed Cover

500

İç Genişlik
Inner Width

R300

Kıvrılma Yarıçapı
Bending Radius

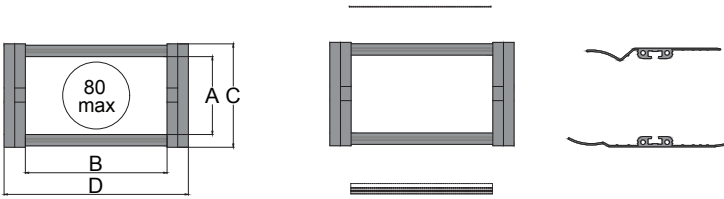

CK110 ALK	A	B _{min} - B _{max}	C	D _{min} - D _{max}	R
MODEL	İç Yükseklik (mm) Inner Height (mm)	İç Genişlik (mm) Inner Width (mm)	Dış Yükseklik (mm) Outer Height (mm)	Dış Genişlik (mm) Outer Width (mm)	Kıvrılma Yarıçapı Bending Radius
CK110 ALK	110	200-800	145	264-864	300, 600

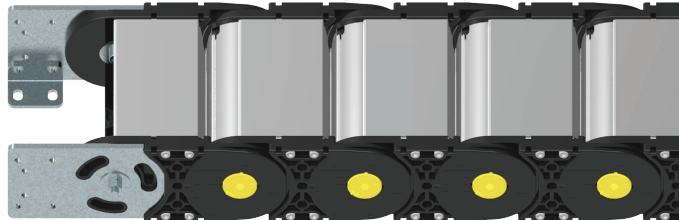

Metal Ayak Montaj Ölçüleri

Metal End Bracket Assembly Dimensions

CK110 M

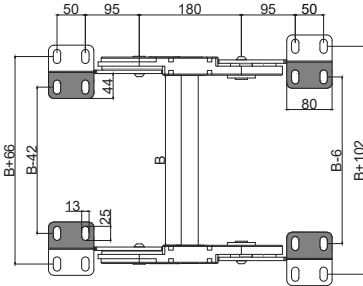

'B' ölçüsünü ölçü tablosundan bulabilirsiniz.
You will find the 'B' dimension from model table.

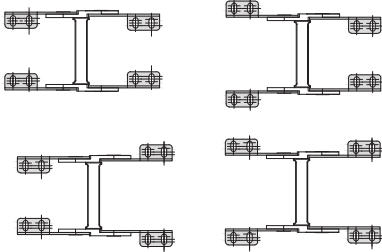

CK110 AL

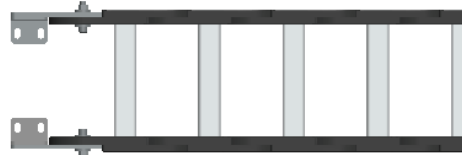

CK110 ALY

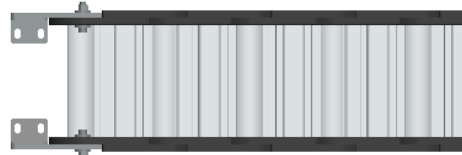

CK110 ALK

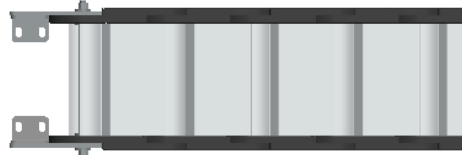

Dikey Separatör Ölçüleri

Vertical Separator Dimensions

CK110 SP

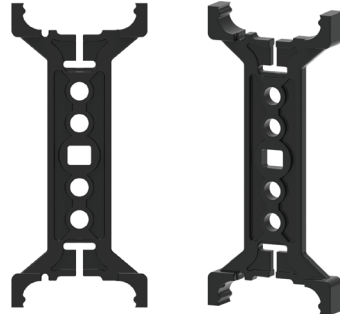
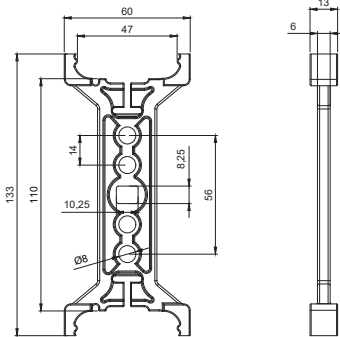

Kablo Taşıyıcı Metal Destek Tava Cable Carrier Steel Guide Channel

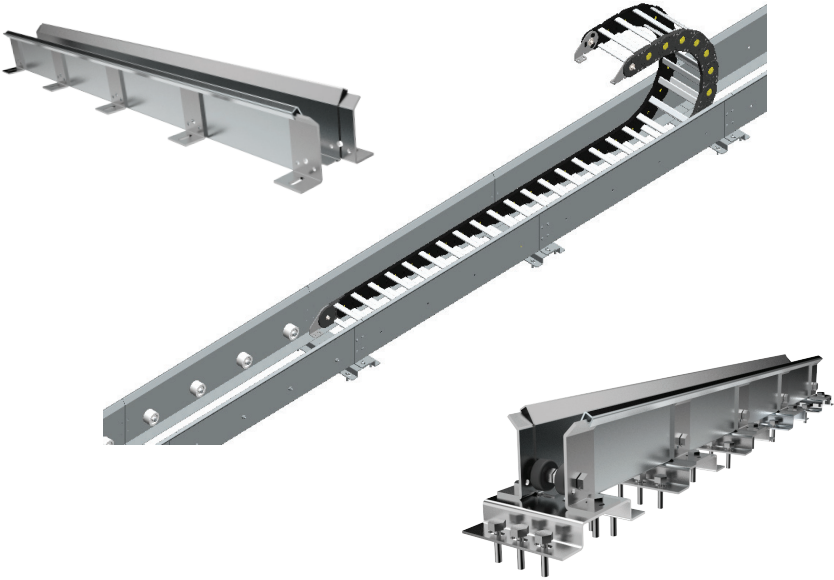

KABLO TAŞIYICI METAL DESTEK TAVA ÖZELLİKLERİ

- Kablo taşıyıcı genişliğine göre ayarlanabilir parçalara sahiptir.
- Uzun metreli tavalarda kullanılan teker sistemi ile sürtünmeleri azaltılır.
- 1 metre uzunluktadır. Özel olarak talebe göre hazırlanabilmektedir.
- Çelikten yapılmış hareketli kablo taşıyıcı tavası
- Yan parçaları çinko kaplamalı çelikten üretilmektedir.
- Düz ve pürüzsüz iç yüzeye sahiptir.
- Yüksek kaliteli malzemeden üretilmektedir.
- Hızlı ve kolay montaja sahiptir.

CABLE CARRIER STEEL GUIDE CHANNEL FEATURES

- Guide Channel made of Steel
- Adjustable to cable chain width
- Side parts made of zinc coated steel
- With fixed module, without any drilling
- Level, smooth, inner surface.
- High-quality design.
- Easy and fast assembly.
- The standard supply length is 1 mt.
- Special lengths are available on request.

Montaj Örneđi Example for Assembly

1. Adım / Step 1

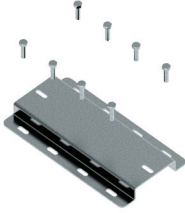

2. Adım / Step 2



3. Adım / Step 3

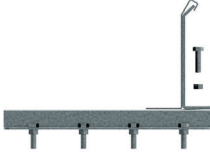

4. Adım / Step 4

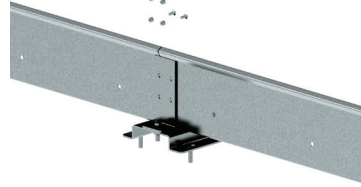

5. Adım / Step 5



6. Adım / Step 6



7. Adım / Step 7



8. Adım / Step 8



CK GC

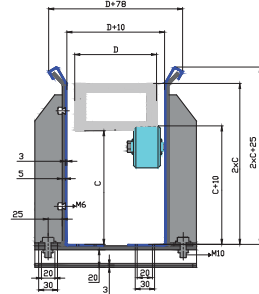
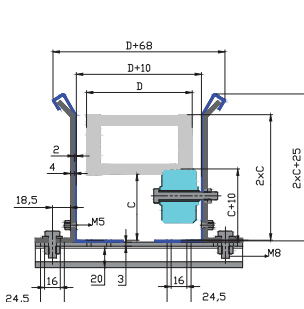

CK24 GC

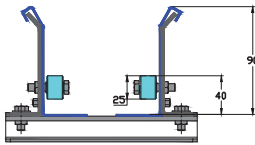

CK25 GC

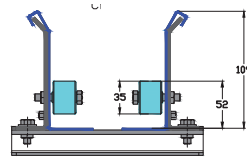

CK30 GC

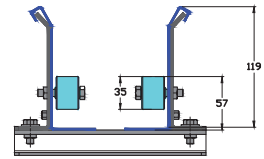

CK35 GC

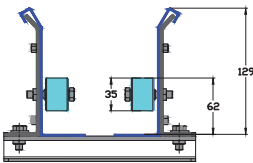

CK42 GC

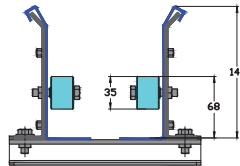

CK40 GC

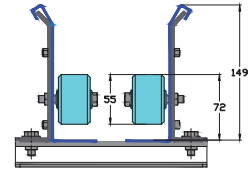

CK60 GC

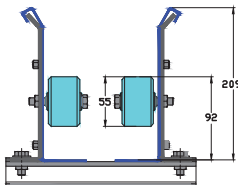

CK80 GC

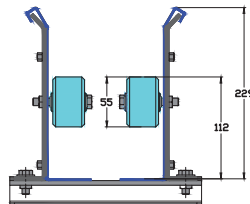

CK110 GC

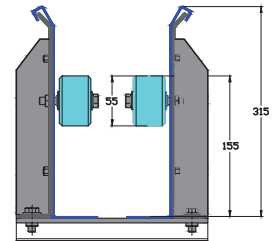

Kablo Taşıyıcı Roller
Cable Carrier Roller

CK R

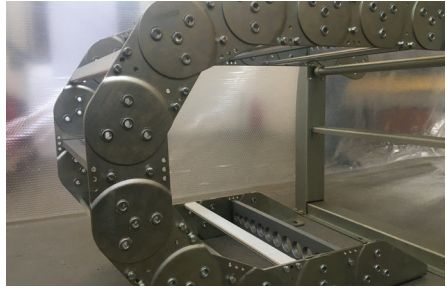
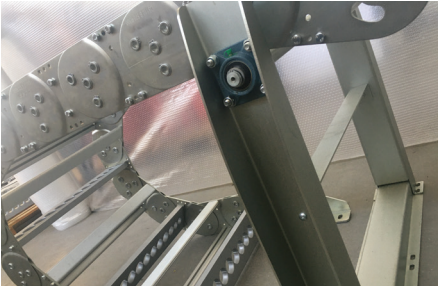
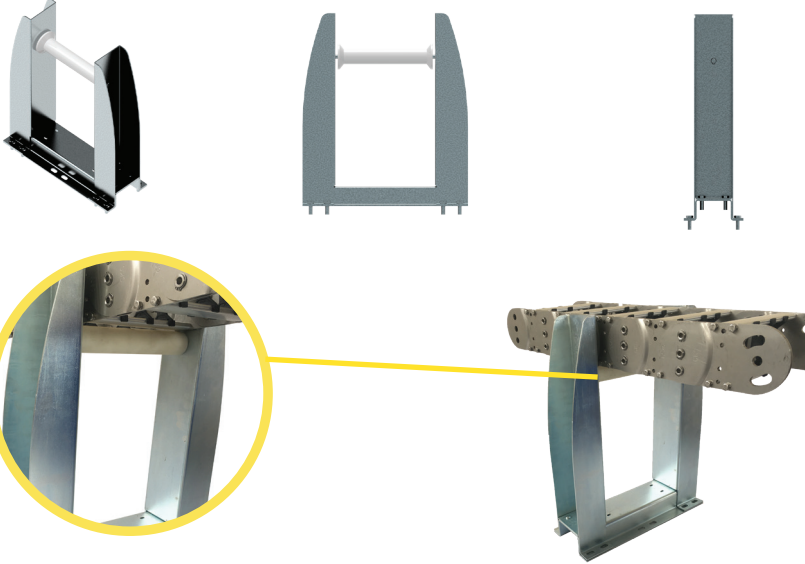

KABLO TAŞIYICI ROLLER ÖZELLİKLERİ

- Kablo taşıyıcının desteklenen uzunluğu aşılsa Roller sistemi ile desteklenebilir.

CABLE CARRIER ROLLER FEATURES

- *If the unsupported length of the cable carrier is exceeded, the upper trough can be supported by rollers.*
- *For long travel tray with using wheels for less friction*