

CK25 A SERİSİ

CK25 A SERIE

CK30 A SERİSİ

CK30 A SERIE

CK35 A-K-Y SERİSİ

CK35 A-K-Y SERIE

CK36 A SERİSİ

CK36 A SERIE

CK42 A-K-Y SERİSİ

CK42 A-K-Y SERIE

PLASTİK ORTA SERİ
PLASTIC MEDIUM SERIE







CK25 A SERİSİ Açık Çıta
CK25 A SERIE Open Frame

MALZEME ÖZELLİKLERİ

MATERIAL FEATURES

PA6 %30 Cam Elyaf | PA6 With %30 Fiber Glass

MAKSİMUM ÇALIŞMA MESAFESİ

MAX TRAVEL DISTANCE

70 metre | 70 meter

HIZ

MAX SPEED

7 m/sn | 7 m/sec

ÇALIŞMA SICAKLIĞI

OPERATING TEMPERATURE

-30 °C ~ + 130 °C

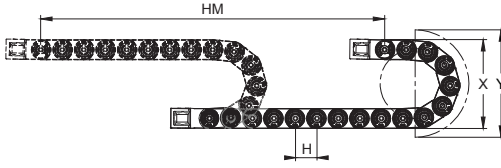

- L** Kullanılacak Miktar
Calculation of the Chain Length
- HM** Hareket Mesafesi
Movement Distance
- X** Montaj Yüksekliği
Mounting Height
- Y** Radyüs Mesafesi
Radius Distance
- H** Hatve
Pitch

$$L = HM / 2 + Y$$

$$X = R \times 2 + C$$

$$Y = R \times \pi$$

Kıvrılma Yarıçapı / Bending Radius	40	75	100	125
H (mm)	42	42	42	42
X (mm)	122	192	242	292
Y (mm)	126	236	314	393

YÜK DİYAGRAMI LOAD DIAGRAM

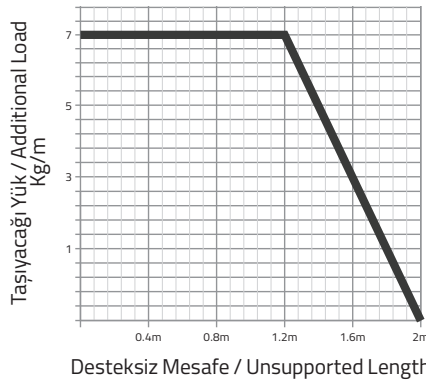

CK25 A SERİSİ

CK25 A SERIE

İçten ve Dıştan Açılabilir Çıta
Openable From Inner and Outside

Örnek Ürün Kodu
Product No. Example

CK25

İç Yükseklik
Inner Height

A

Açık Seri
Open Serie

050

İç Genişlik
Inner Width

R075

Kıvrılma Yarıçapı
Bending Radius

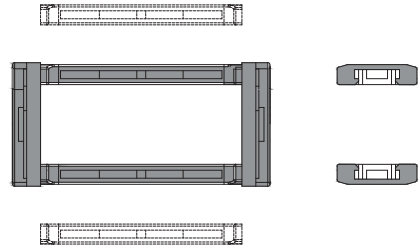
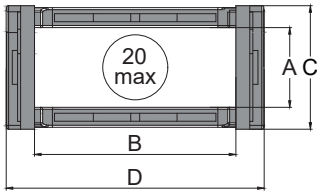

CK25 A	A	B	C	D	R	W
MODEL	İç Yükseklik (mm) Inner Height (mm)	İç Genişlik (mm) Inner Width (mm)	Dış Yükseklik (mm) Outer Height (mm)	Dış Genişlik (mm) Outer Width (mm)	Kıvrılma Yarıçapı Bending Radius	Ağırlık Kg/Mt Weight Kg/Mt
CK25 A 040 R ...	25	40	42	62	40, 75, 100, 125	1,044
CK25 A 050 R ...		50		72		1,092
CK25 A 060 R ...		60		82		1,140
CK25 A 080 R ...		80		102		1,236
CK25 A 100 R ...		100		122		1,332

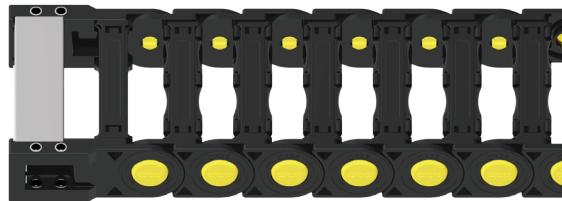

Plastik Dikey Seperator Ölçüleri

Plastic Vertical Seperator Dimensions

CK25 SP

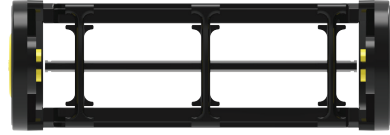
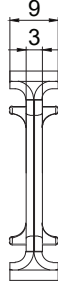
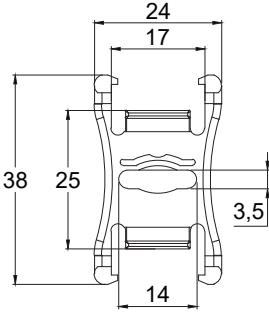

Plastik Yatay Seperator Ölçüleri

Plastic Horizontal Seperator Dimensions

CK25 YSP

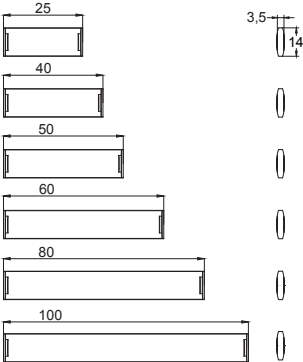

Plastik Ayak Montaj Ölçüleri

Plastic End Bracket Assembly Dimensions

CK25 P - NP

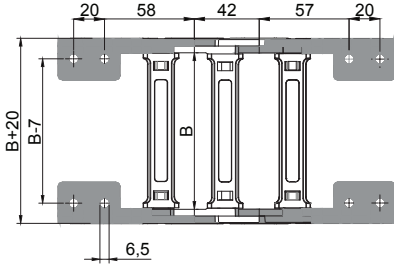

'B' ölçüsünü ölçü tablosundan bulabilirsiniz.
You will find the 'B' dimension from model table.

CK25 P

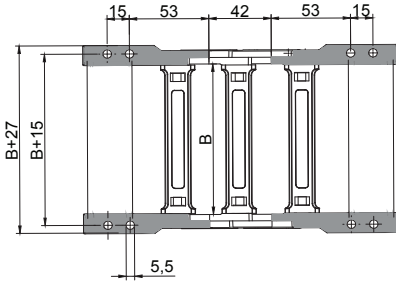
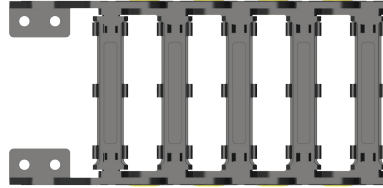

'B' ölçüsünü ölçü tablosundan bulabilirsiniz.
You will find the 'B' dimension from model table.

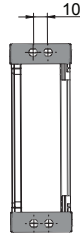

CK25 NP

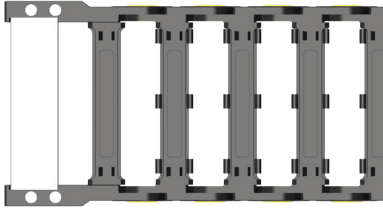

Plastik Ayak Bağlantı Şekilleri

Plastic End Bracket Assembly

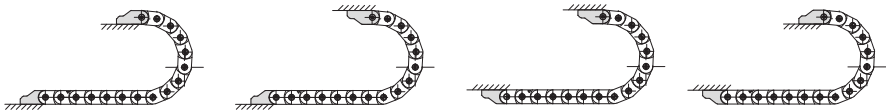

Metal Ayak Montaj Ölçüleri

Steel End Bracket Assembly Dimensions

CK25 M

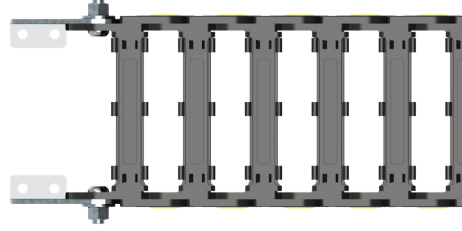
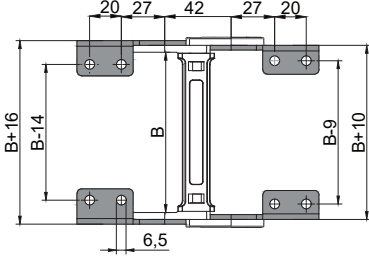

'B' ölçüsünü ölçü tablosundan bulabilirsiniz.
You will find the 'B' dimension from model table.

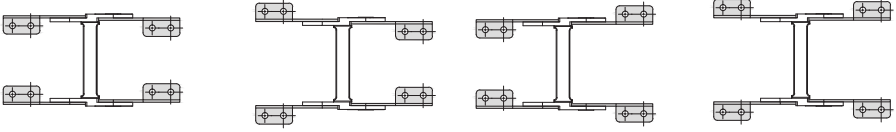

Metal Ayak Bağlantı Şekilleri

Steel End Bracket Assembly

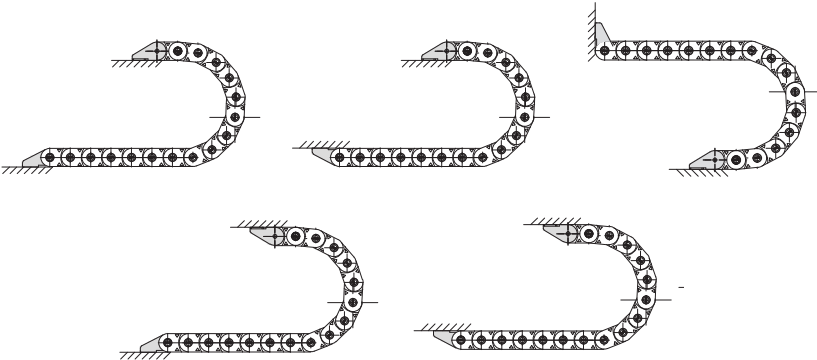



CK30 A SERİSİ Açık Çıta
CK30 A SERIE Open Frame

MALZEME ÖZELLİKLERİ

MATERIAL FEATURES

PA6 %30 Cam Elyaf | PA6 With %30 Fiber Glass

MAKSİMUM ÇALIŞMA MESAFESİ

MAX TRAVEL DISTANCE

70 metre | 70 meter

HIZ

MAX SPEED

7 m/sn | 7 m/sec

ÇALIŞMA SICAKLIĞI

OPERATING TEMPERATURE

-30°C ~ + 130°C

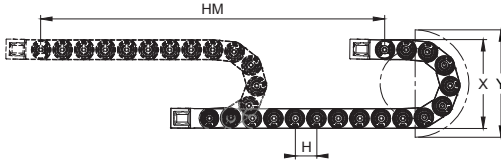

- L** Kullanılacak Miktar
Calculation of the Chain Length
- HM** Hareket Mesafesi
Movement Distance
- X** Montaj Yüksekliği
Mounting Height
- Y** Radyüs Mesafesi
Radius Distance
- H** Hatve
Pitch

$$L = HM / 2 + Y$$

$$X = R \times 2 + C$$

$$Y = R \times \pi$$

Kıvrılma Yarıçapı / Bending Radius	50	75	100	150
H (mm)	52	52	52	52
X (mm)	147	197	247	347
Y (mm)	157	236	314	471

YÜK DİYAGRAMI LOAD DIAGRAM

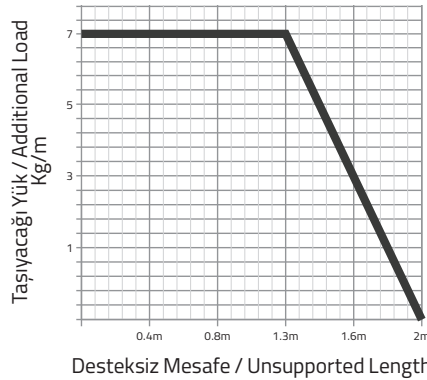

CK30 A SERİSİ

CK30 A SERIE

İçten ve Dıştan Açılabilir Çıta
Openable From Inner and Outside

Örnek Ürün Kodu
Product No. Example

CK30

İç Yükseklik
Inner Height

A

Açık Seri
Open Serie

060

İç Genişlik
Inner Width

R100

Kıvrılma Yarıçapı
Bending Radius

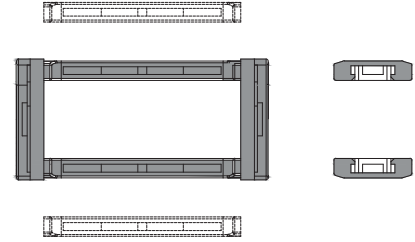
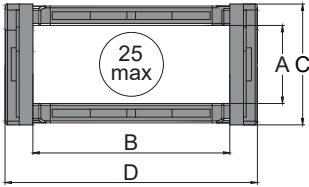

CK30 A	A	B	C	D	R	W
MODEL	İç Yükseklik (mm) Inner Height (mm)	İç Genişlik (mm) Inner Width (mm)	Dış Yükseklik (mm) Outer Height (mm)	Dış Genişlik (mm) Outer Width (mm)	Kıvrılma Yarıçapı Bending Radius	Ağırlık Kg/Mt Weight Kg/Mt
CK30 A 040 R ...	30	40	47	62	50, 75, 100, 150	1,152
CK30 A 050 R ...		50		72		1,190
CK30 A 060 R ...		60		82		1,228
CK30 A 080 R ...		80		102		1,304
CK30 A 100 R ...		100		122		1,380

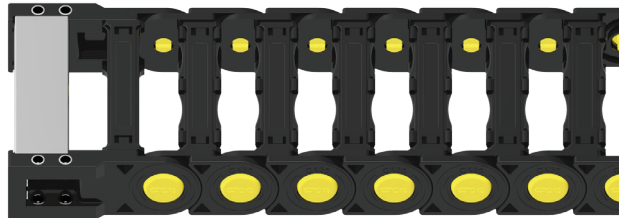

Plastik Dikey Seperatör Ölçüleri

Plastic Vertical Seperator Dimensions

CK30 SP

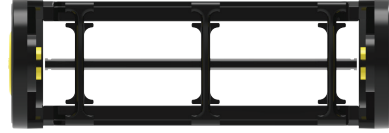
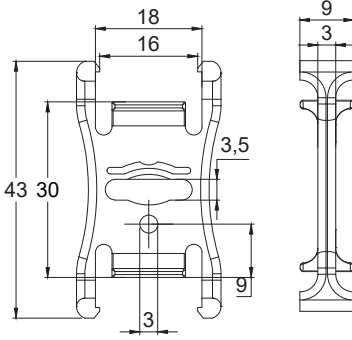

Plastik Yatay Seperatör Ölçüleri

Plastic Horizontal Seperator Dimensions

CK30 YSP

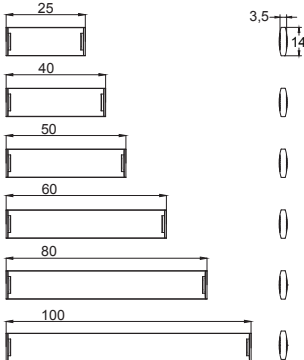

Plastik Ayak Montaj Ölçüleri Plastic End Bracket Assembly Dimensions

CK30 P - NP

CK30 P

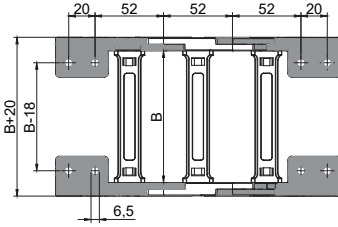

CK30 P

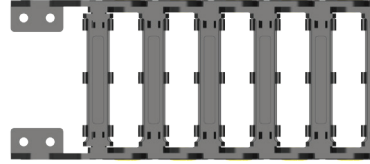

'B' ölçüsünü ölçü tablosundan bulabilirsiniz.
You will find the 'B' dimension from model table.

CK30 NP

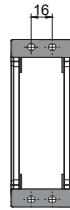
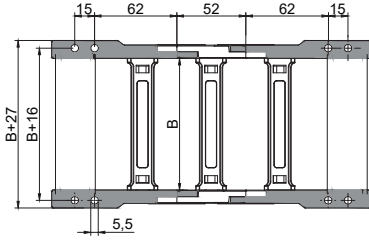

CK30 NP

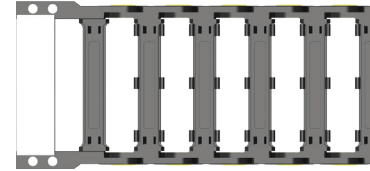

'B' ölçüsünü ölçü tablosundan bulabilirsiniz.
You will find the 'B' dimension from model table.

Plastik Ayak Bağlantı Şekilleri Plastic End Bracket Assembly

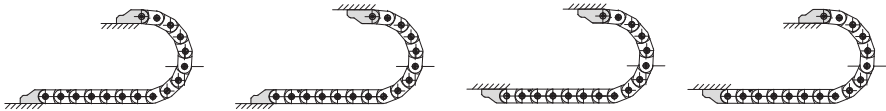

Metal Ayak Montaj Ölçüleri

Steel End Bracket Assembly Dimensions

CK30 M

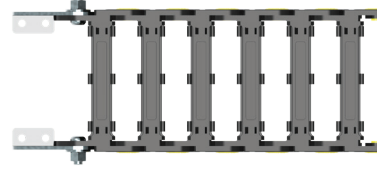
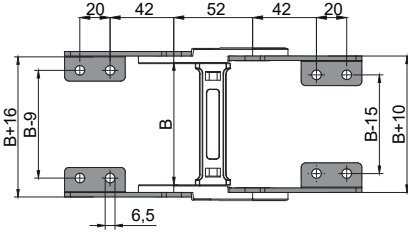

'B' ölçüsünü ölçü tablosundan bulabilirsiniz.
You will find the 'B' dimension from model table.

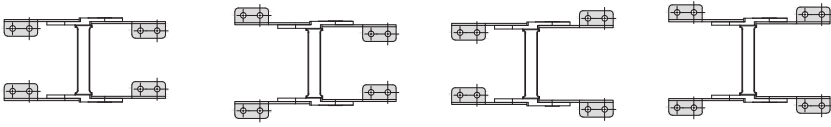

Metal Ayak Bağlantı Şekilleri

Steel End Bracket Assembly

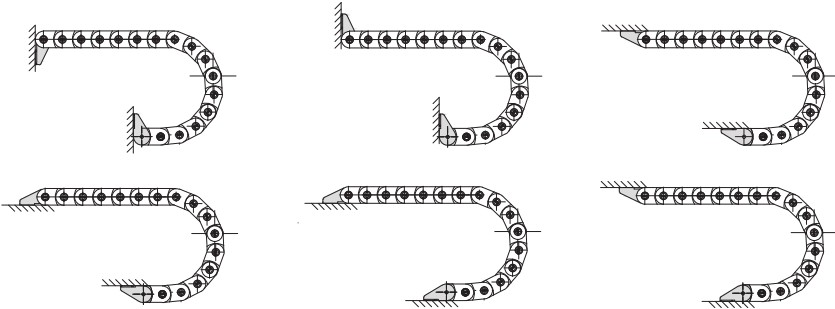



CK35 A SERİSİ Açık Çıta
CK35 A SERIE Open Frame

CK35 K SERİSİ Kapalı Kapak
CK35 K SERIE Closed Cover

CK35 Y SERİSİ Yarı Kapalı Kapak
CK35 Y SERIE Half Covered

MALZEME ÖZELLİKLERİ
MATERIAL FEATURES

PA6 %30 Cam Elyaf | PA6 With %30 Fiber Glass

MAKSİMUM ÇALIŞMA MESAFESİ
MAX TRAVEL DISTANCE

80 metre | 80 meter

HIZ
MAX SPEED

7 m/sn | 7 m/sec

ÇALIŞMA SICAKLIĞI
OPERATING TEMPERATURE

-30°C ~ + 130°C

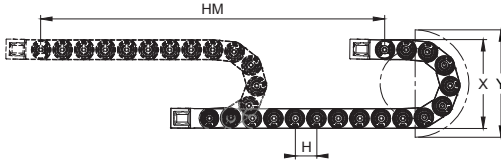

- L** Kullanılacak Miktar
Calculation of the Chain Length
- HM** Hareket Mesafesi
Movement Distance
- X** Montaj Yüksekliği
Mounting Height
- Y** Radüs Mesafesi
Radius Distance
- H** Hatve
Pitch

$$L = HM / 2 + Y$$

$$X = R \times 2 + C$$

$$Y = R \times \pi$$

Kıvrılma Yarıçapı / Bending Radius	50	75	100	125	150
H (mm)	56	56	56	56	56
X (mm)	152	202	252	302	352
Y (mm)	157	236	314	393	471

* Kapalı ve Yarı Açık serilerin radiusleri 75'ten başlamaktadır /
The Closed Cover and Half Covered type product radius is started from R75

YÜK DİYAGRAMI LOAD DIAGRAM

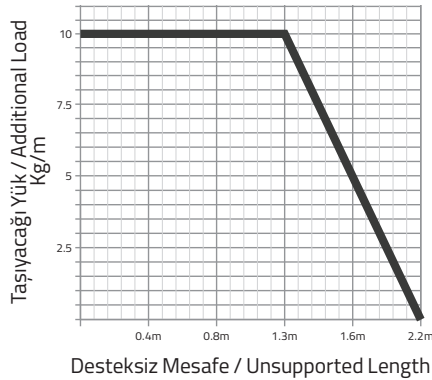

CK35 A SERİSİ

CK35 A SERIE

İçten ve Dıştan Açılabilir Çıta
Openable From Inner and Outside

Örnek Ürün Kodu
Product No. Example

CK35

A

060

R100

İç Yükseklik
Inner Height

Açık Seri
Open Serie

İç Genişlik
Inner Width

Kıvrılma Yarıçapı
Bending Radius

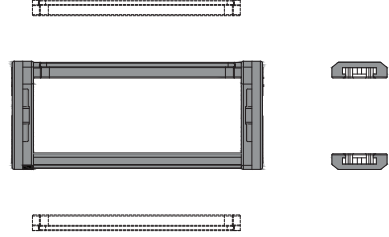
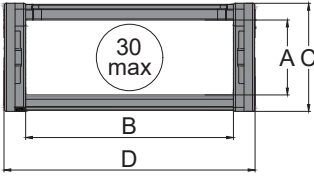

CK35 A	A	B	C	D	R	W
MODEL	İç Yükseklik (mm) Inner Height (mm)	İç Genişlik (mm) Inner Width (mm)	Dış Yükseklik (mm) Outer Height (mm)	Dış Genişlik (mm) Outer Width (mm)	Kıvrılma Yarıçapı Bending Radius	Ağırlık Kg/Mt Weight Kg/Mt
CK35 A 040 R ...	35	40	52	64	50, 75, 100, 125, 150	1,296
CK35 A 050 R ...		50		74		1,332
CK35 A 060 R ...		60		84		1,368
CK35 A 070 R ...		70		94		1,404
CK35 A 080 R ...		80		104		1,440
CK35 A 100 R ...		100		124		1,512
CK35 A 120 R ...		120		144		1,584
CK35 A 125 R ...		125		149		1,620
CK35 A 140 R ...		140		165		1,690
CK35 A 175 R ...		175		199		1,800



CK35 Kapalı Serilerin R075 inde Klips Kullanılmaz

The Clips Does Not Use On The Covers For R075 in The CK35 Closed Serie.

CK35 K SERİSİ

CK35 K SERIE

İçten ve Dıştan Açılabilir Kapak
Openable From Inner and Outside Cover

Örnek Ürün Kodu
Product No. Example

CK35

İç Yükseklik
Inner Height

K

Kapalı Kapak
Closed Cover

060

İç Genişlik
Inner Width

R100

Kıvrılma Yarıçapı
Bending Radius

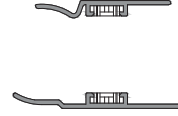
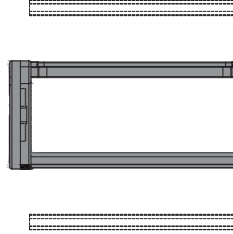
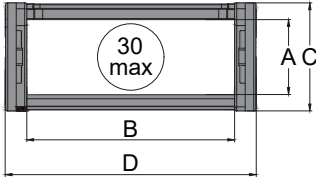

CK35 K	A	B	C	D	R	W
MODEL	İç Yükseklik (mm) Inner Height (mm)	İç Genişlik (mm) Inner Width (mm)	Dış Yükseklik (mm) Outer Height (mm)	Dış Genişlik (mm) Outer Width (mm)	Kıvrılma Yarıçapı Bending Radius	Ağırlık Kg/Mt Weight Kg/Mt
CK35 K 040 R ...	35	40	52	64	75, 100, 125, 150	1,494
CK35 K 060 R ...		60		84		1,656
CK35 K 080 R ...		80		104		1,836
CK35 K 100 R ...		100		124	1,998	
CK35 K 125 R ...		125		149	2,178	



CK35 Y SERİSİ

CK35 Y SERIE

İçten ve Dıştan Açılabilir Kapak
Openable From Inner and Outside

Örnek Ürün Kodu
Product No. Example

CK35

İç Yükseklik
Inner Height

Y

Yarı Açık Seri
Half Covered

060

İç Genişlik
Inner Width

R100

Kıvrılma Yarıçapı
Bending Radius

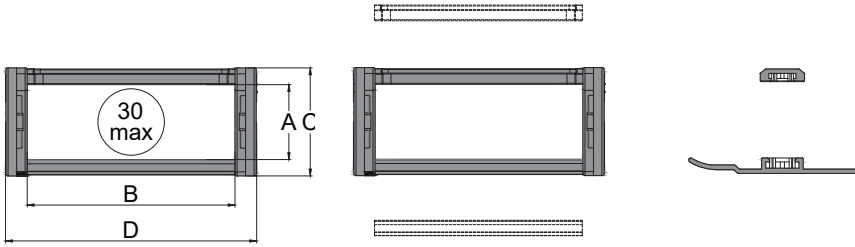

CK35 Y	A	B	C	D	R	W
MODEL	İç Yükseklik (mm) Inner Height (mm)	İç Genişlik (mm) Inner Width (mm)	Dış Yükseklik (mm) Outer Height (mm)	Dış Genişlik (mm) Outer Width (mm)	Kıvrılma Yarıçapı Bending Radius	Ağırlık Kg/Mt Weight Kg/Mt
CK35 Y 040 R ...	35	40	52	64	75, 100, 125, 150	1,404
CK35 Y 060 R ...		60		84		1,530
CK35 Y 080 R ...		80		104	100, 125, 150	1,656
CK35 Y 100 R ...		100		124		1,782
CK35 Y 125 R ...		125		149	1,926	



Açık Seri Plastik Dikey Seperator Ölçüleri

Open Type Plastic Vertical Separator Dimensions

CK35 SP

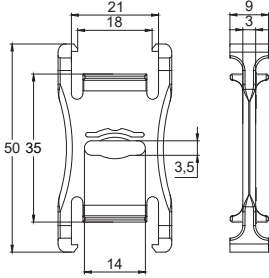

Kapalı Seri Plastik Dikey Seperator Ölçüleri

Closed Type Plastic Vertical Separator Dimensions

CK35 KSP

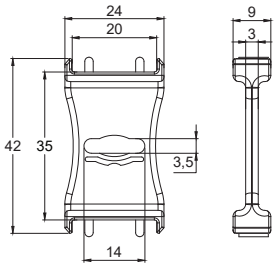

Plastik Yatay Seperator Ölçüleri

Plastic Horizontal Separator Dimensions

CK35 YSP

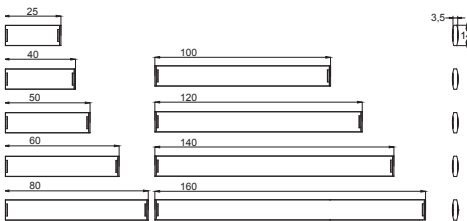

Plastik Ayak Montaj Ölçüleri

Plastic End Bracket Assembly Dimensions

CK35 P

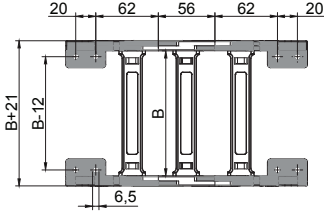

'B' ölçüsünü ölçü tablosundan bulabilirsiniz.
You will find the 'B' dimension from model table.

CK35 NP

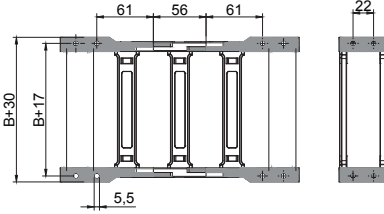

'B' ölçüsünü ölçü tablosundan bulabilirsiniz.
You will find the 'B' dimension from model table.

Plastik Ayak Bağlantı Şekilleri

Plastic End Bracket Assembly

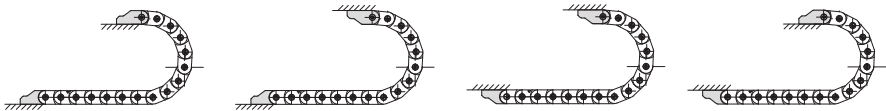

CK35 P - NP

CK35 PA



CK35 PK



CK35 PY



CK35 NPA



CK35 NPK



CK35 NPY



Metal Ayak Montaj Ölçüleri

Steel End Bracket Assembly Dimensions

CK35 M

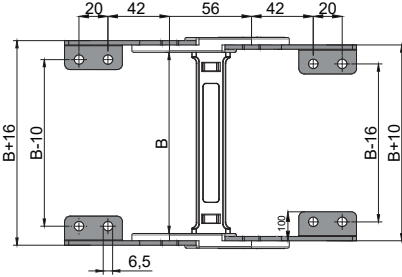

'B' ölçüsünü ölçü tablosundan bulabilirsiniz.
You will find the 'B' dimension from model table.

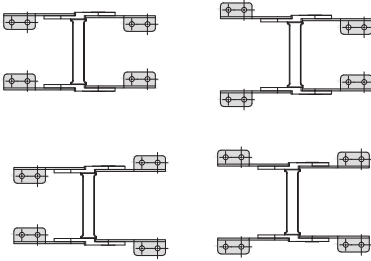

CK35 A

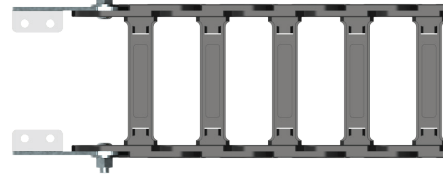

CK35 K

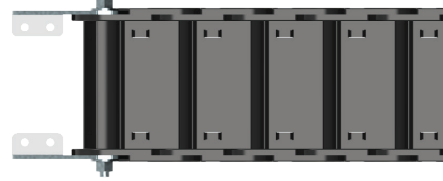

CK35 Y



Metal Ayak Bağlantı Şekilleri

Steel End Bracket Assembly

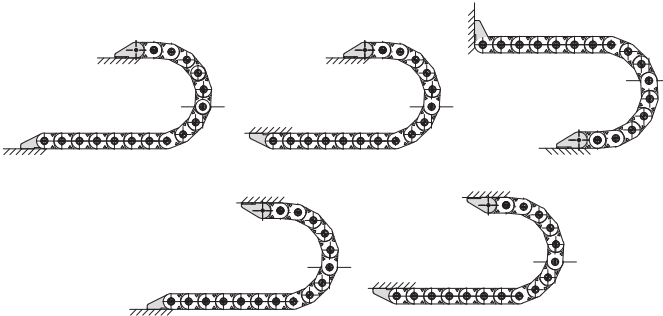

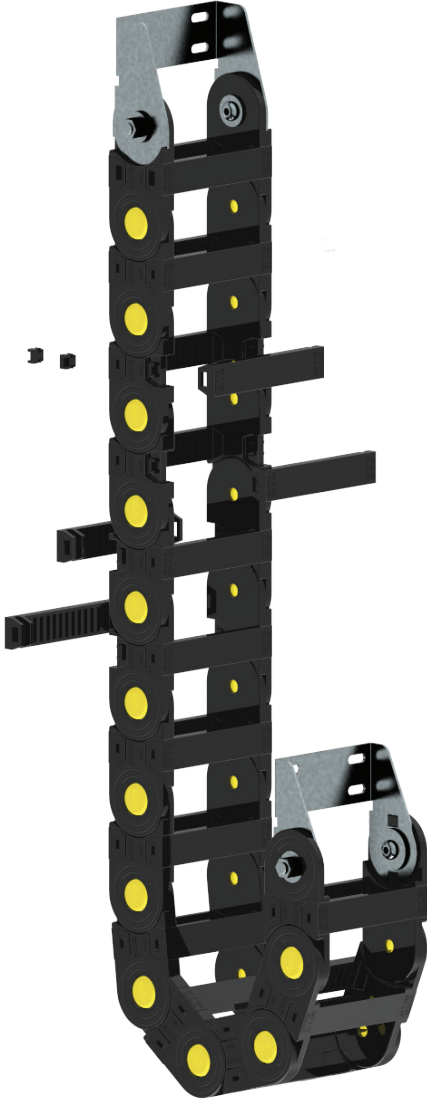

CK36 A SERİSİ Açık Çıta
CK36 A SERIE Open Frame

MALZEME ÖZELLİKLERİ

MATERIAL FEATURES

PA6 %30 Cam Elyaf | PA6 With %30 Fiber Glass

MAKSİMUM ÇALIŞMA MESAFESİ

MAX TRAVEL DISTANCE

80 metre | 80 meter

HIZ

MAX SPEED

7 m/sn | 7 m/sec

ÇALIŞMA SICAKLIĞI

OPERATING TEMPERATURE

-30°C ~ + 130°C

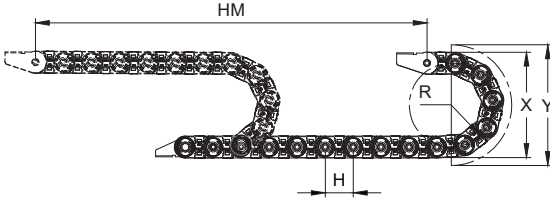

L Kullanılacak Miktar
Calculation of the Chain Length

HM Hareket Mesafesi
Movement Distance

X Montaj Yüksekliği
Mounting Height

Y RADIUS Mesafesi
Radius Distance

H Hatve
Pitch

$$L = HM / 2 + Y$$

$$X = R \times 2 + C$$

$$Y = R \times \pi$$

Kıvrılma Yarıçapı / Bending Radius

	55	75
H (mm)	66	66
X (mm)	162	202
Y (mm)	173	235

YÜK DİYAGRAMI LOAD DIAGRAM

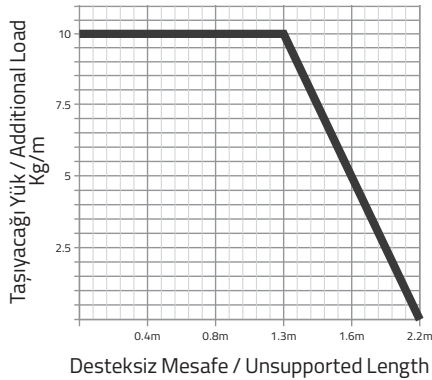

CK36 A SERİSİ

CK36 A SERIE

İçten ve Dıştan Açılabilir Çıta
Openable From Inner and Outside

Örnek Ürün Kodu
Product No. Example

CK36

İç Yükseklik
Inner Height

A

Açık Seri
Open Serie

050

İç Genişlik
Inner Width

R075

Kıvrılma Yarıçapı
Bending Radius

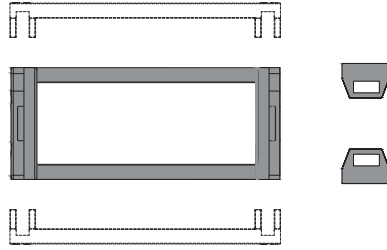
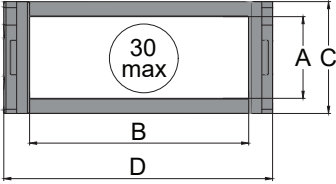

CK36 A	A	B	C	D	R	W
MODEL	İç Yükseklik (mm) Inner Height (mm)	İç Genişlik (mm) Inner Width (mm)	Dış Yükseklik (mm) Outer Height (mm)	Dış Genişlik (mm) Outer Width (mm)	Kıvrılma Yarıçapı Bending Radius	Ağırlık Kg/Mt Weight Kg/Mt
CK36 A 050 R075	36	50	52	75	55, 75	1,5
CK36 A 080 R075		80		105		1,65
CK36 A 100 R075		100		125		1,725



Metal Ayak Montaj Ölçüleri

Steel End Bracket Assembly Dimensions

CK36 M

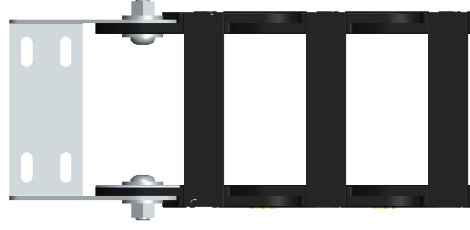
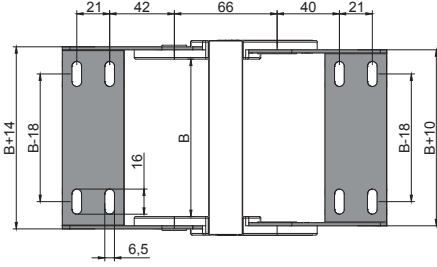

'B' ölçüsünü ölçü tablosundan bulabilirsiniz.
You will find the 'B' dimension from model table.

Metal Ayak Bağlantı Şekilleri

Steel End Bracket Assembly

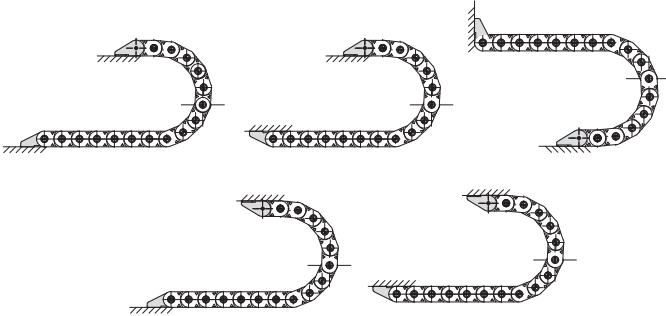



CK42 A SERİSİ Açık Çıta
CK42 A SERIE Open Frame

CK42 K SERİSİ Kapalı Kapak
CK42 K SERIE Closed Cover

CK42 Y SERİSİ Yarı Kapalı Kapak
CK42 Y SERIE Half Covered

MALZEME ÖZELLİKLERİ
MATERIAL FEATURES

PA6 %30 Cam Elyaf | PA6 With %30 Fiber Glass

MAKSİMUM ÇALIŞMA MESAFESİ
MAX TRAVEL DISTANCE

80 metre | 80 meter

HIZ
MAX SPEED

7 m/sn | 7 m/sec

ÇALIŞMA SICAKLIĞI
OPERATING TEMPERATURE

-30°C ~ + 130°C

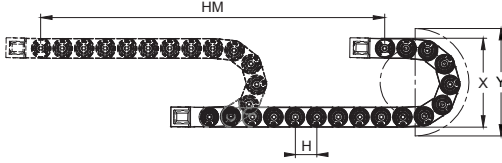

L Kullanılacak Miktar
Calculation of the Chain Length

HM Hareket Mesafesi
Movement Distance

X Montaj Yüksekliği
Mounting Height

Y RADIUS Mesafesi
Radius Distance

H Hatve
Pitch

$$L = HM / 2 + Y$$

$$X = R \times 2 + C$$

$$Y = R \times \pi$$

Kıvrılma Yarıçapı / Bending Radius	75	100	150	200
H (mm)	62,5	62,5	62,5	62,5
X (mm)	208	258	358	458
Y (mm)	236	314	471	628

* Kapalı ve Yarı Açık serilerin radiusleri 100'den başlamaktadır /
The Closed Cover and Half Covered type product radius is started from R100

YÜK DİYAGRAMI LOAD DIAGRAM

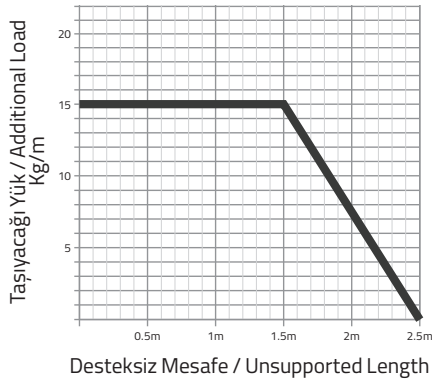

CK42 A SERİSİ

İçten ve Dıştan Açılabilir Çıta
Openable From Inner and Outside

CK42 A SERIE

Örnek Ürün Kodu
Product No. Example

CK42

İç Yükseklik
Inner Height

A

Açık Seri
Open Series

050

İç Genişlik
Inner Width

R075

Kıvrılma Yarıçapı
Bending Radius

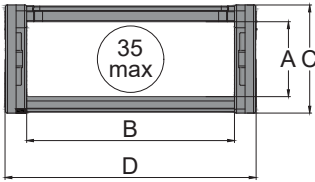

CK42 A	A	B	C	D	R	W
MODEL	İç Yükseklik (mm) Inner Height (mm)	İç Genişlik (mm) Inner Width (mm)	Dış Yükseklik (mm) Outer Height (mm)	Dış Genişlik (mm) Outer Width (mm)	Kıvrılma Yarıçapı Bending Radius	Ağırlık Kg/Mt Weight Kg/Mt
CK42 A 040 R ...	42	40	58	67	75, 100, 150, 200, 250	1,578
CK42 A 050 R ...		50		77		1,610
CK42 A 060 R ...		60		87		1,642
CK42 A 070 R ...		70		97		1,674
CK42 A 080 R ...		80		107		1,706
CK42 A 100 R ...		100		127		1,770
CK42 A 120 R ...		120		147		1,834
CK42 A 125 R ...		125		152		1,866
CK42 A 140 R ...		140		167		1,923
CK42 A 175 R ...		175		202		2,026

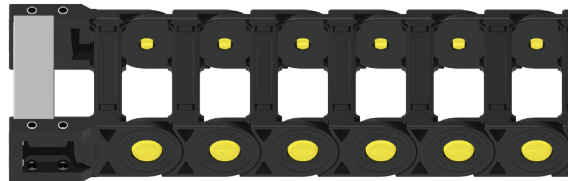

CK42 K SERİSİ

CK42 K SERIE

İçten ve Dıştan Açılabilir Kapak
Openable From Inner and Outside Cover

Örnek Ürün Kodu
Product No. Example

CK42

İç Yükseklik
Inner Height

K

Kapalı Seri
Closed Serie

080

İç Genişlik
Inner Width

R100

Kıvrılma Yarıçapı
Bending Radius

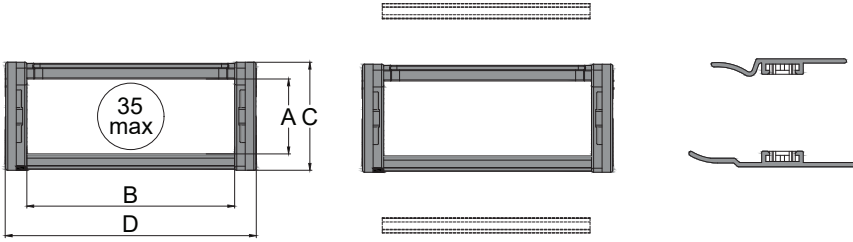

CK42 K	A	B	C	D	R	W
MODEL	İç Yükseklik (mm) Inner Height (mm)	İç Genişlik (mm) Inner Width (mm)	Dış Yükseklik (mm) Outer Height (mm)	Dış Genişlik (mm) Outer Width (mm)	Kıvrılma Yarıçapı Bending Radius	Ağırlık Kg/Mt Weight Kg/Mt
CK42 K 050 R ...	42	50	58	77	100, 150, 200, 250	1,866
CK42 K 080 R ...		80		107		2,122
CK42 K 100 R ...		100		127		2,298
CK42 K 125 R ...		125		152		2,490



CK42 Y SERİSİ

CK42 Y SERIE

İçten ve Dıştan Açılabilir Kapak
Openable From Inner and Outside Cover

CK42

İç Yükseklik
Inner Height

Y

Yarı Açık Seri
Half Covered

080

İç Genişlik
Inner Width

R100

Kıvrılma Yarıçapı
Bending Radius

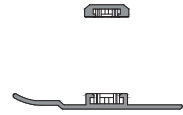
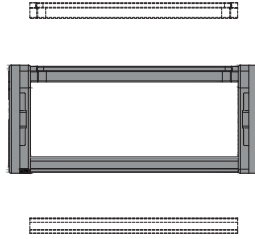
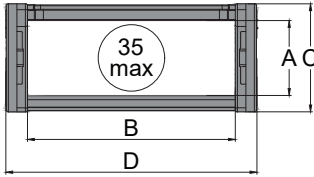

CK42 Y	A	B	C	D	R	W
MODEL	İç Yükseklik (mm) <i>Inner Height (mm)</i>	İç Genişlik (mm) <i>Inner Width (mm)</i>	Dış Yükseklik (mm) <i>Outer Height (mm)</i>	Dış Genişlik (mm) <i>Outer Width (mm)</i>	Kıvrılma Yarıçapı <i>Bending Radius</i>	Ağırlık Kg/Mt <i>Weight Kg/Mt</i>
CK42 Y 050 R ...	42	50	58	77	100, 150, 200, 250	1,738
CK42 Y 080 R ...		80		107		1,930
CK42 Y 100 R ...		100		127		2,058
CK42 Y 125 R ...		125		152		2,022



Açık Seri Plastik Dikey Seperator Ölçüleri

Open Type Plastic Vertical Separator Dimensions

CK42 SP

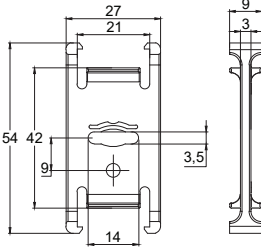

Kapalı Seri Plastik Dikey Seperator Ölçüleri

Closed Type Plastic Vertical Separator Dimensions

CK42 KSP

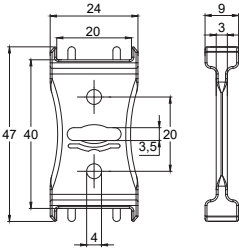

Plastik Yatay Seperator Ölçüleri

Plastic Horizontal Separator Dimensions

CK42 YSP

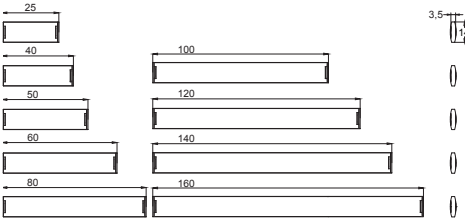

Plastik Ayak Montaj Ölçüleri

Plastic End Bracket Assembly Dimensions

CK42 P

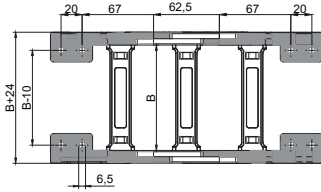

'B' ölçüsünü ölçü tablosundan bulabilirsiniz.
You will find the 'B' dimension from model table.

CK42 NP

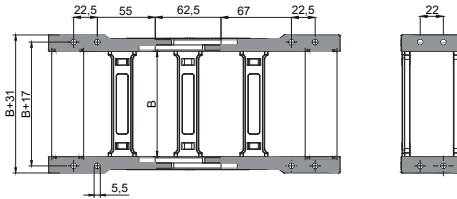

'B' ölçüsünü ölçü tablosundan bulabilirsiniz.
You will find the 'B' dimension from model table.

CK42 P - NP

CK42 PA



CK42 PK



CK42 PY



CK42 NPA



CK42 NPK



CK42 NPY



Plastik Ayak Bağlantı Şekilleri

Plastic End Bracket Assembly

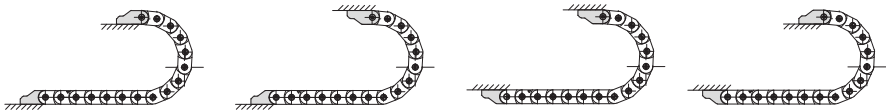

Metal Ayak Montaj Ölçüleri

Steel End Bracket Assembly Dimensions

CK42 M

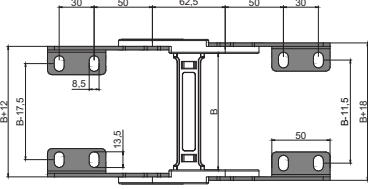

'B' ölçüsünü ölçü tablosundan bulabilirsiniz.
You will find the 'B' dimension from model table.

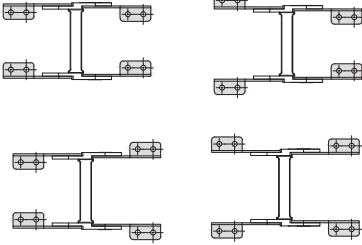

CK42 A

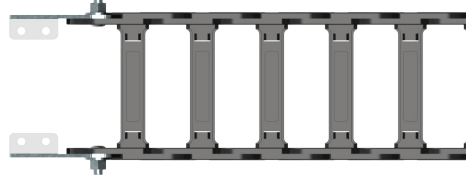

CK42 K

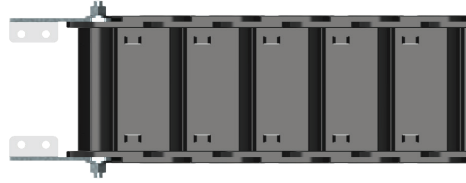

CK42 Y

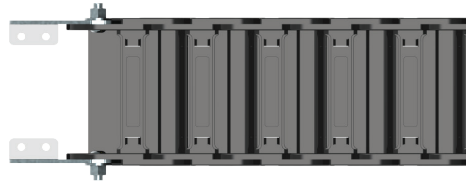

Metal Ayak Bağlantı Şekilleri

Steel End Bracket Assembly

