

CK07 F SERİSİ

CK07 F SERIE

CK10 F SERİSİ

CK10 F SERIE

CK15 A-B-F SERİSİ

CK15 A-B-F SERIE

CK18 A-B-F SERİSİ

CK18 A-B-F SERIE

CK20 F-Y SERİSİ

CK20 F-Y SERIE

CK24 A-B-F SERİSİ

CK24 A-B-F SERIE



PLASTİK HAFİF SERİ
PLASTIC LIGHT SERIE



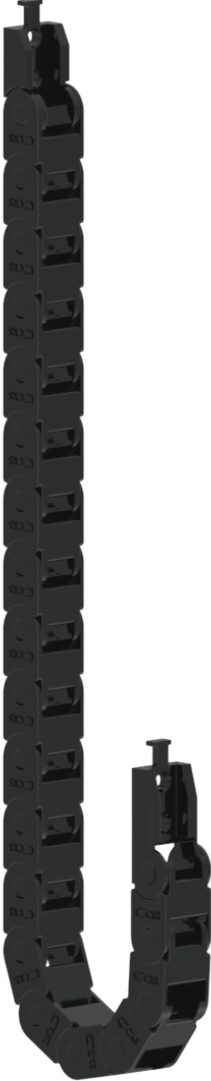

CK07 F SERİSİ Sabit Çıta
CK07 F SERIE Fixed Frame

MALZEME ÖZELLİKLERİ
MATERIAL FEATURES

PA6 %30 Cam Elyaf | PA6 With %30 Fiber Glass

MAKSİMUM ÇALIŞMA MESAFESİ
MAX TRAVEL DISTANCE

Lütfen İrtibata Geçiniz. | Please contact.

HIZ
MAX SPEED

8 m/sn | 8 m/sec

ÇALIŞMA SICAKLIĞI
OPERATING TEMPERATURE

-30°C ~ + 130°C

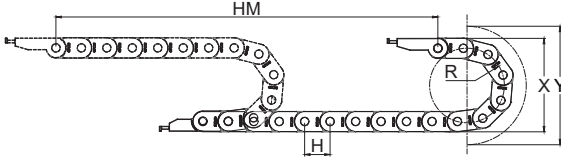

- L** Kullanılacak Miktar
Calculation of the Chain Length
- HM** Hareket Mesafesi
Movement Distance
- X** Montaj Yüksekliği
Mounting Height
- Y** Radyüs Mesafesi
Radius Distance
- H** Hatve
Pitch

$$L = HM / 2 + Y$$

$$X = R \times 2 + C$$

$$Y = R \times \pi$$

Kıvrılma Yarıçapı / Bending Radius

18

H (mm)

12,5

X (mm)

46

Y (mm)

57

YÜK DİYAGRAMI LOAD DIAGRAM

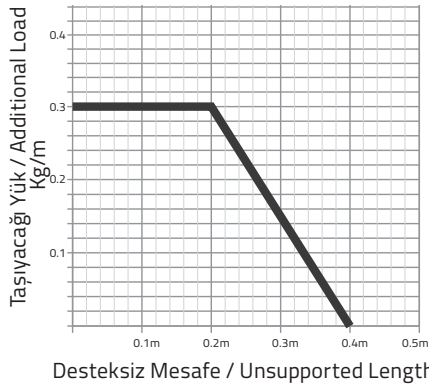

CK07 F SERİSİ

Sabit Çıta
Fixed Frame

CK07 F SERIE

Örnek Ürün Kodu
Product No. Example

CK07

İç Yükseklik
Inner Height

F

Sabit Çıta
Fixed Frame

007

İç Genişlik
Inner Width

R018

Kıvrılma Yarıçapı
Bending Radius

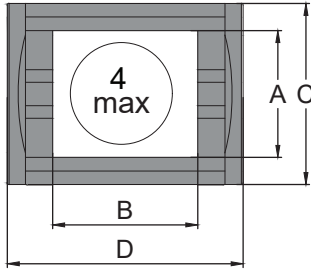

CK07 F	A	B	C	D	R	W
MODEL	İç Yükseklik (mm) Inner Height (mm)	İç Genişlik (mm) Inner Width (mm)	Dış Yükseklik (mm) Outer Height (mm)	Dış Genişlik (mm) Outer Width (mm)	Kıvrılma Yarıçapı Bending Radius	Ağırlık Kg/Mt Weight Kg/Mt
CK07 F 007 R018	7	7	10	12	18	0,07
CK07 F 016 R018	7	16	10	21	18	0,10



Plastik Ayak Montaj Ölçüleri

Plastic End Bracket Assembly Dimensions

CK07 P

CK07 P

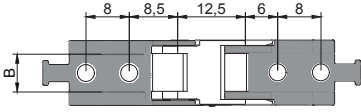

CK07 P07

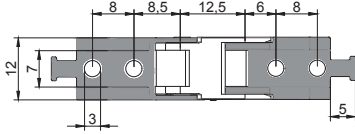

CK07 P16

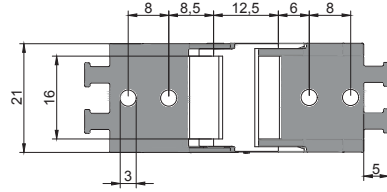

Plastik Ayak Bağlantı Şekilleri

Plastic End Bracket Assembly

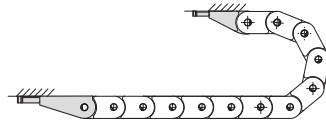
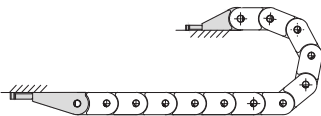
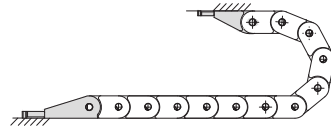
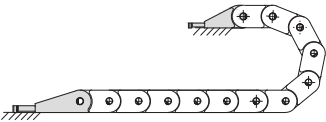

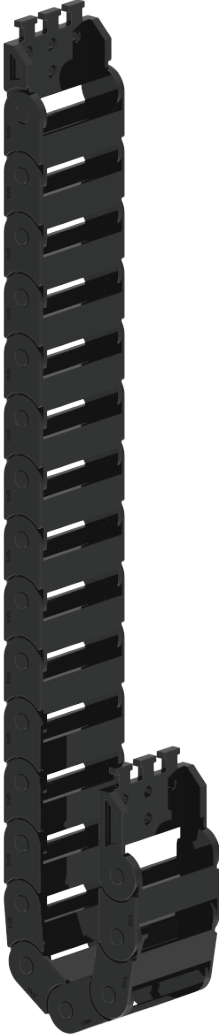

CK10 F SERİSİ Sabit Çıta
CK10 F SERIE Fixed Frame

MALZEME ÖZELLİKLERİ

MATERIAL FEATURES

PA6 %30 Cam Elyaf | PA6 With %30 Fiber Glass

MAKSİMUM ÇALIŞMA MESAFESİ

MAX TRAVEL DISTANCE

Lütfen İrtibata Geçiniz. | Please contact.

HIZ

MAX SPEED

8 m/sn | 8 m/sec

ÇALIŞMA SICAKLIĞI

OPERATING TEMPERATURE

-30°C ~ + 130°C

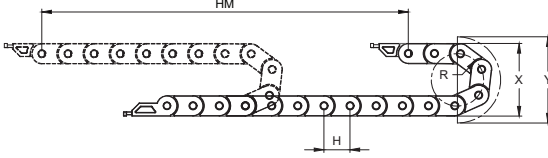

L Kullanılacak Miktar
Calculation of the Chain Length

HM Hareket Mesafesi
Movement Distance

X Montaj Yüksekliği
Mounting Height

Y Radyüs Mesafesi
Radius Distance

H Hatve
Pitch

$$L = HM / 2 + Y$$

$$X = R \times 2 + C$$

$$Y = R \times \pi$$

Kıvrılma Yarıçapı / Bending Radius

H (mm)

X (mm)

Y (mm)

18

18

50

57

YÜK DİYAGRAMI LOAD DIAGRAM

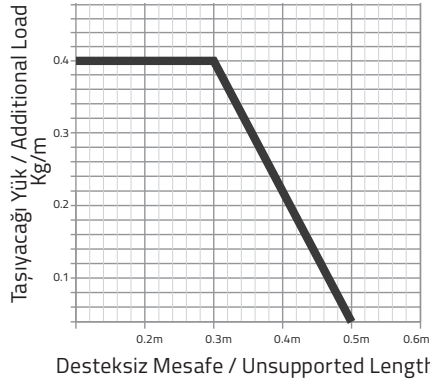

CK10 F SERİSİ

Sabit Çıta

CK10 F SERIE

Fixed Frame

Örnek Ürün Kodu
Product No. Example

CK10

İç Yükseklik
Inner Height

F

Sabit Çıta
Fixed Frame

010

İç Genişlik
Inner Width

R018

Kıvrılma Yarıçapı
Bending Radius

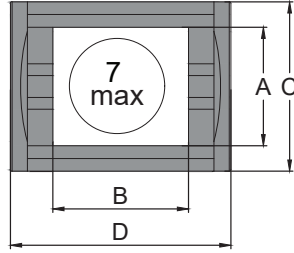

CK10 F	A	B	C	D	R	W
MODEL	İç Yükseklik (mm) Inner Height (mm)	İç Genişlik (mm) Inner Width (mm)	Dış Yükseklik (mm) Outer Height (mm)	Dış Genişlik (mm) Outer Width (mm)	Kıvrılma Yarıçapı Bending Radius	Ağırlık Kg/Mt Weight Kg/Mt
CK10 F 010 R018	10	10	14	16	18	0,123
CK10 F 020 R018	10	20	14	26	18	0,154
CK10 F 030 R018	10	30	14	36	18	0,183



Plastik Ayak Montaj Ölçüleri

Plastic End Bracket Assembly Dimensions

CK10 P

CK10 P

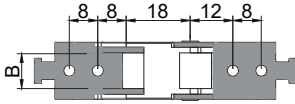

CK10 P10

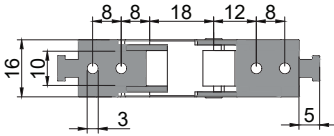

CK10 P20

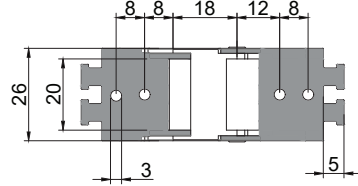

CK10 P30

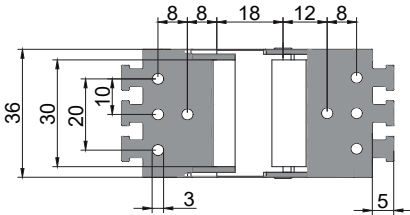

Plastik Ayak Bağlantı Şekilleri

Plastic End Bracket Assembly

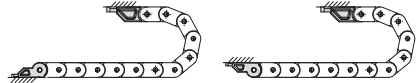
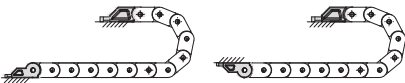

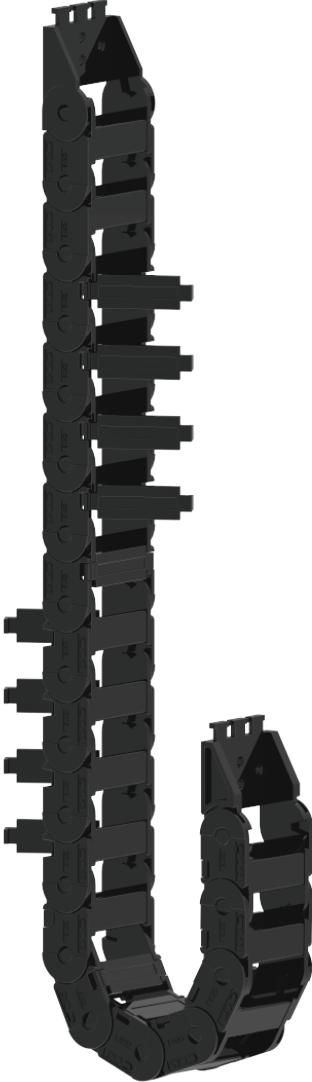

CK15 A SERİSİ içten Açılabilir
CK15 A SERIE Openable From Inner Side

CK15 B SERİSİ Dıştan Açılabilir
CK15 B SERIE Openable From Outside

CK15 F SERİSİ Sabit Çıta
CK15 F SERIE Fixed Frame

MALZEME ÖZELLİKLERİ
MATERIAL FEATURES

PA6 %30 Cam Elyaf | PA6 With %30 Fiber Glass

MAKSİMUM ÇALIŞMA MESAFESİ
MAX TRAVEL DISTANCE

Lütfen İrtibata Geçiniz. | Please contact.

HIZ
MAX SPEED
9 m/sn | 9 m/sec

ÇALIŞMA SICAKLIĞI
OPERATING TEMPERATURE
-30°C ~ + 130°C

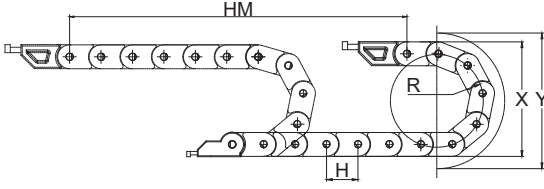

- L** Kullanılacak Miktar
Calculation of the Chain Length
- HM** Hareket Mesafesi
Movement Distance
- X** Montaj Yüksekliği
Mounting Height
- Y** Radüs Mesafesi
Radius Distance
- H** Hatve
Pitch

$$L = HM / 2 + Y$$

$$X = R \times 2 + C$$

$$Y = R \times \pi$$

Kıvrılma Yarıçapı / Bending Radius	25	35
H (mm)	25	25
X (mm)	70	90
Y (mm)	78,5	110

YÜK DİYAGRAMI LOAD DIAGRAM

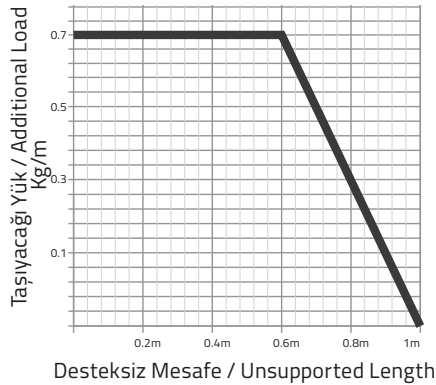

CK15 A SERİSİ

İçten Açılabilir Çıta

CK15 A SERIE

Openable From Inner Side

Örnek Ürün Kodu
Product No. Example

CK15

İç Yükseklik
Inner Height

A

İçten Açılabilir
Openable From Inner Side

015

İç Genişlik
Inner Width

R025

Kıvrılma Yarıçapı
Bending Radius

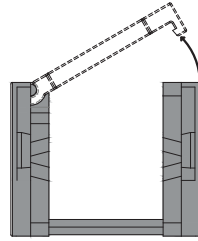
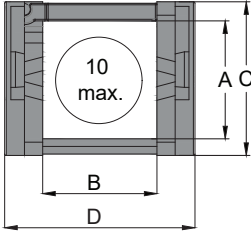

CK15 A	A	B	C	D	R	W
MODEL	İç Yükseklik (mm) Inner Height (mm)	İç Genişlik (mm) Inner Width (mm)	Dış Yükseklik (mm) Outer Height (mm)	Dış Genişlik (mm) Outer Width (mm)	Kıvrılma Yarıçapı Bending Radius	Ağırlık Kg/Mt Weight Kg/Mt
CK15 A 015 R ...	15	15	20	25	25-35	0,266
CK15 A 020 R ...	15	20	20	30	25-35	0,282
CK15 A 030 R ...	15	30	20	40	25-35	0,310
CK15 A 040 R ...	15	40	20	50	25-35	0,336

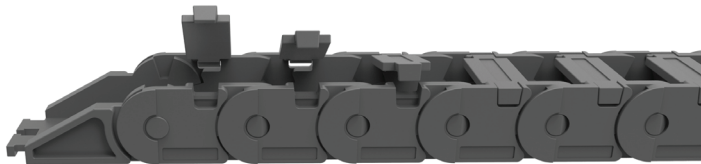

CK15 B SERİSİ

CK15 B SERIE

Dıştan Açılabilir Çıta
Openable From Outside

Örnek Ürün Kodu
Product No. Example

CK15

İç Yükseklik
Inner Height

B

Dıştan Açılabilir
Openable From Outside

015

İç Genişlik
Inner Width

R025

Kıvrılma Yarıçapı
Bending Radius

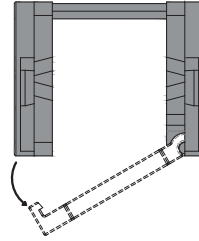
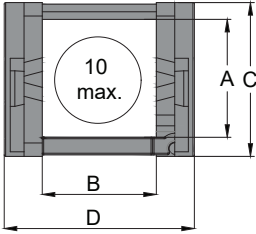

CK15 B	A	B	C	D	R	W
MODEL	İç Yükseklik (mm) Inner Height (mm)	İç Genişlik (mm) Inner Width (mm)	Diş Yükseklik (mm) Outer Height (mm)	Diş Genişlik (mm) Outer Width (mm)	Kıvrılma Yarıçapı Bending Radius	Ağırlık Kg/Mt Weight Kg/Mt
CK15 B 015 R ...	15	15	20	25	25-35	0,266
CK15 B 020 R ...	15	20	20	30	25-35	0,282
CK15 B 030 R ...	15	30	20	40	25-35	0,310
CK15 B 040 R ...	15	40	20	50	25-35	0,336

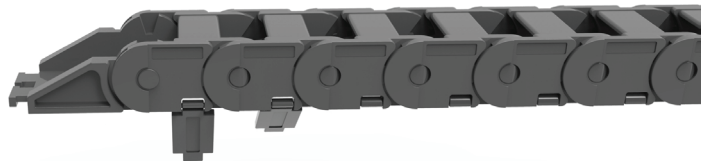

CK15 F SERİSİ

Sabit Çıta

Fixed Frame

CK15 F SERİ

Örnek Ürün Kodu
Product No. Example

CK15

İç Yükseklik
Inner Height

F

Sabit Çıta
Fixed Frame

015

İç Genişlik
Inner Width

R025

Kıvrılma Yarıçapı
Bending Radius

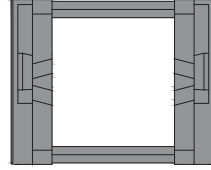
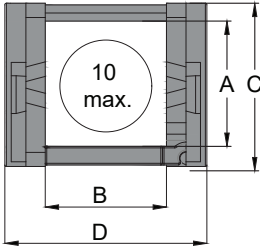

CK15 F	A	B	C	D	R	W
MODEL	İç Yükseklik (mm) Inner Height (mm)	İç Genişlik (mm) Inner Width (mm)	Dış Yükseklik (mm) Outer Height (mm)	Dış Genişlik (mm) Outer Width (mm)	Kıvrılma Yarıçapı Bending Radius	Ağırlık Kg/Mt Weight Kg/Mt
CK15 F 015 R ...	15	15	20	25	25-35	0,266
CK15 F 020 R ...	15	20	20	30	25-35	0,282
CK15 F 030 R ...	15	30	20	40	25-35	0,310
CK15 F 040 R ...	15	40	20	50	25-35	0,336

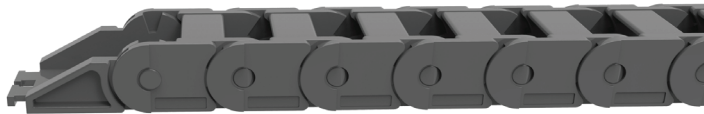

Plastik Ayak Montaj Ölçüleri

Plastic End Bracket Assembly Dimensions

CK15 P

CK15 P

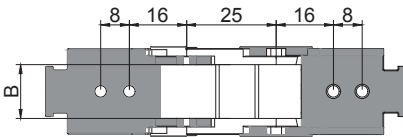

CK15 A



CK15 B



CK15 F



CK15 P15

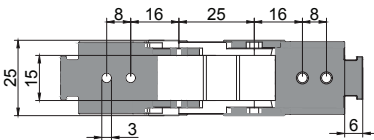

CK15 P20

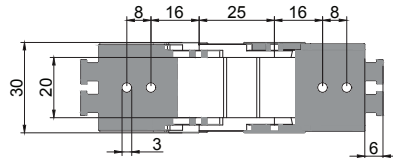

CK15 P30

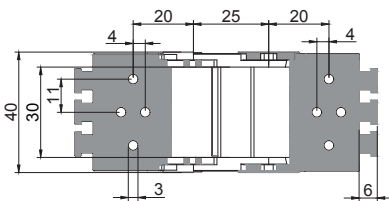

CK15 P40

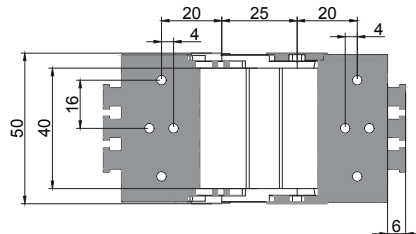

Plastik Ayak Bağlantı Şekilleri

Plastic End Bracket Assembly

CK15 P

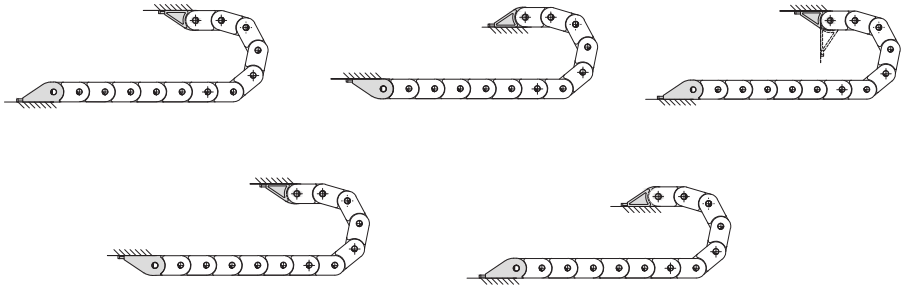

Montaj-Demontaj Uygulaması

Assembly-Disassembly Application

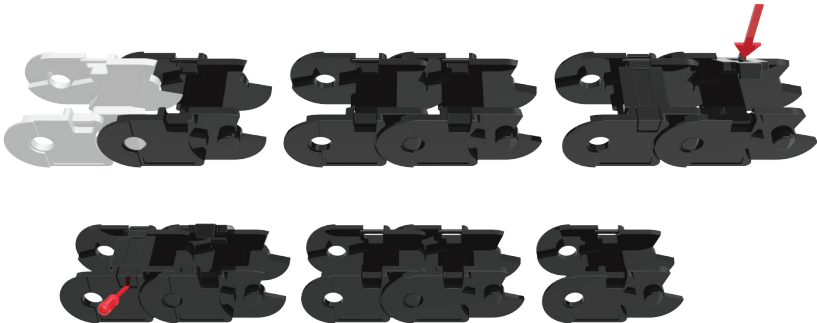

CK15



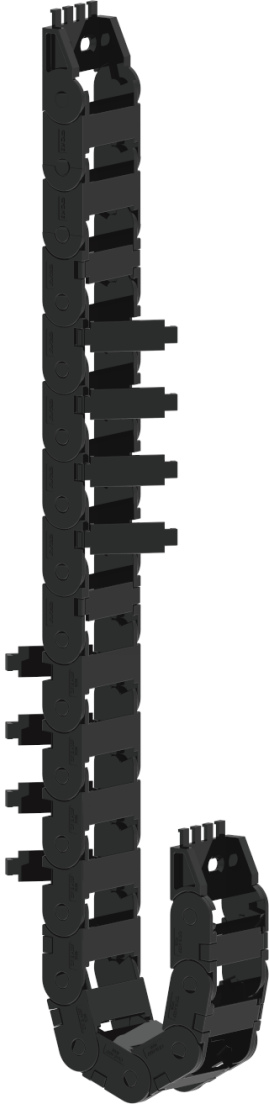

CK18 A SERİSİ içten Açılabilir
CK18 A SERIE Openable From Inner Side

CK18 B SERİSİ Dıştan Açılabilir
CK18 B SERIE Openable From Outside

CK18 F SERİSİ Sabit Çıta
CK18 F SERIE Fixed Frame

MALZEME ÖZELLİKLERİ
MATERIAL FEATURES

PA6 %30 Cam Elyaf | PA6 With %30 Fiber Glass

MAKSİMUM ÇALIŞMA MESAFESİ
MAX TRAVEL DISTANCE

40 metre | 40 meter

HIZ
MAX SPEED

9 m/sn | 9 m/sec

ÇALIŞMA SICAKLIĞI
OPERATING TEMPERATURE

-30°C ~ + 130°C

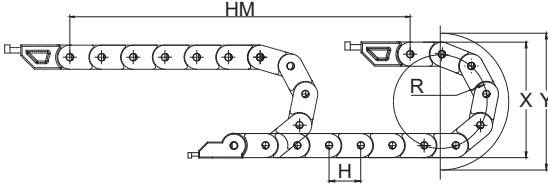

- L** Kullanılacak Miktar
Calculation of the Chain Length
- HM** Hareket Mesafesi
Movement Distance
- X** Montaj Yüksekliği
Mounting Height
- Y** Radyüs Mesafesi
Radius Distance
- H** Hatve
Pitch

$$L = HM / 2 + Y$$

$$X = R \times 2 + C$$

$$Y = R \times \pi$$

Kıvrılma Yarıçapı / Bending Radius

H (mm)	33
X (mm)	100
Y (mm)	119

YÜK DİYAGRAMI LOAD DIAGRAM

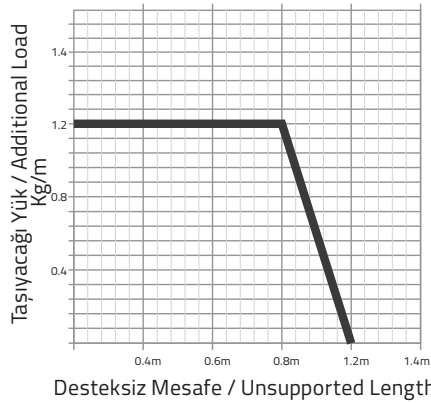

CK18 A SERİSİ

CK18 A SERIE

İçten Açılabilir Çıta
Openable From Inner Side

Örnek Ürün Kodu
Product No. Example

CK18

İç Yükseklik
Inner Height

A

İçten Açılabilir
Openable From Inner Side

025

İç Genişlik
Inner Width

R038

Kıvrılma Yarıçapı
Bending Radius

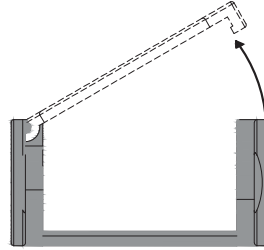
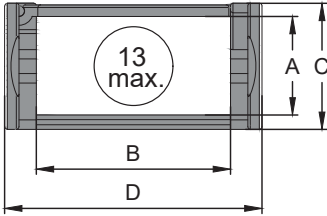

CK18 A	A	B	C	D	R	W
MODEL	İç Yükseklik (mm) Inner Height (mm)	İç Genişlik (mm) Inner Width (mm)	Diş Yükseklik (mm) Outer Height (mm)	Diş Genişlik (mm) Outer Width (mm)	Kıvrılma Yarıçapı Bending Radius	Ağırlık Kg/Mt Weight Kg/Mt
CK18 A 025 R ...	18	25	24	37	38	0,368
CK18 A 037 R ...	18	37	24	49	38	0,435
CK18 A 050 R ...	18	50	24	62	38	0,452
CK18 A 060 R ...	18	60	24	72	38	0,479

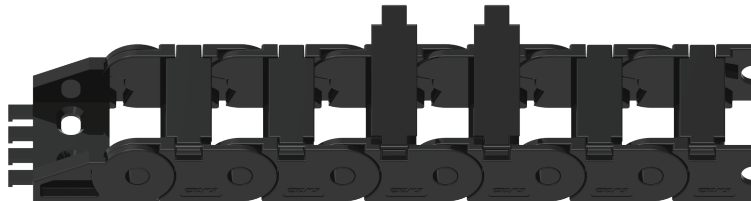

CK18 B SERİSİ

CK18 B SERIE

Dıştan Açılabilir Çıta
Openable From Outside

Örnek Ürün Kodu
Product No. Example

CK18

İç Yükseklik
Inner Height

B

Dıştan Açılabilir
Openable From Outside

037

İç Genişlik
Inner Width

R038

Kıvrılma Yarıçapı
Bending Radius

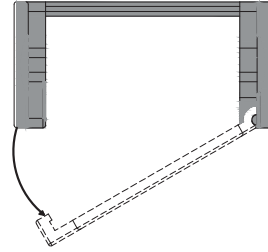
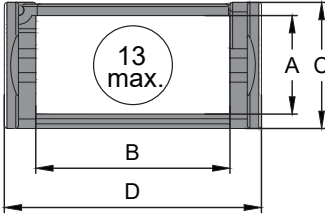

CK18 B	A	B	C	D	R	W
MODEL	İç Yükseklik (mm) Inner Height (mm)	İç Genişlik (mm) Inner Width (mm)	Dış Yükseklik (mm) Outer Height (mm)	Dış Genişlik (mm) Outer Width (mm)	Kıvrılma Yarıçapı Bending Radius	Ağırlık Kg/Mt Weight Kg/Mt
CK18 B 025 R ...	18	25	24	37	38	0,368
CK18 B 037 R ...	18	37	24	49	38	0,435
CK18 B 050 R ...	18	50	24	62	38	0,452
CK18 B 060 R ...	18	60	24	72	38	0,479

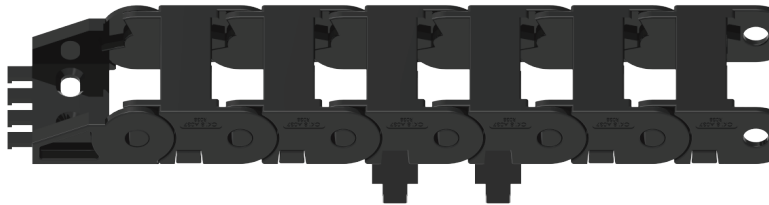

CK18 F SERİSİ

Sabit Çıta

CK18 F SERIE

Fixed Frame

Örnek Ürün Kodu
Product No. Example

CK18

İç Yükseklik
Inner Height

F

Sabit Çıta
Fixed Frame

025

İç Genişlik
Inner Width

R038

Kıvrılma Yarıçapı
Bending Radius

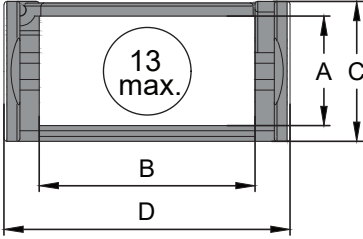

CK18 F	A	B	C	D	R	W
MODEL	İç Yükseklik (mm) Inner Height (mm)	İç Genişlik (mm) Inner Width (mm)	Dış Yükseklik (mm) Outer Height (mm)	Dış Genişlik (mm) Outer Width (mm)	Kıvrılma Yarıçapı Bending Radius	Ağırlık Kg/Mt Weight Kg/Mt
CK18 F 025 R 038	18	25	24	37	38	0,382



Plastik Ayak Montaj Ölçüleri Plastic End Bracket Assembly Dimensions

CK18 P

CK18 P

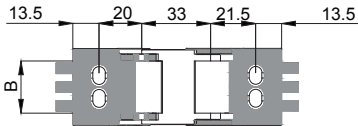

CK18 A



CK18 B



CK18 F



CK18 P25

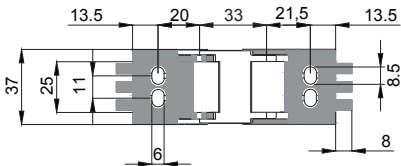

CK18 P37

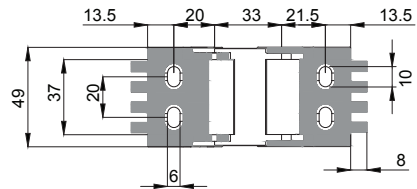

CK18 P50

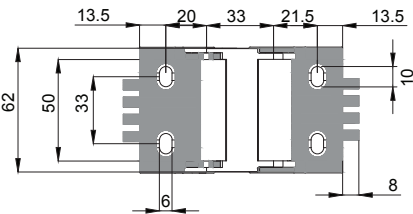

CK18 P60

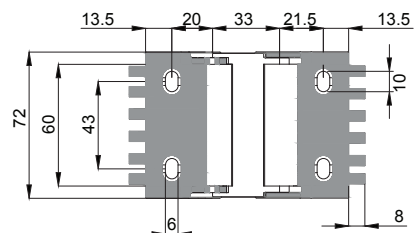

Plastik Ayak Bağlantı Şekilleri

Plastic End Bracket Assembly

CK18 P

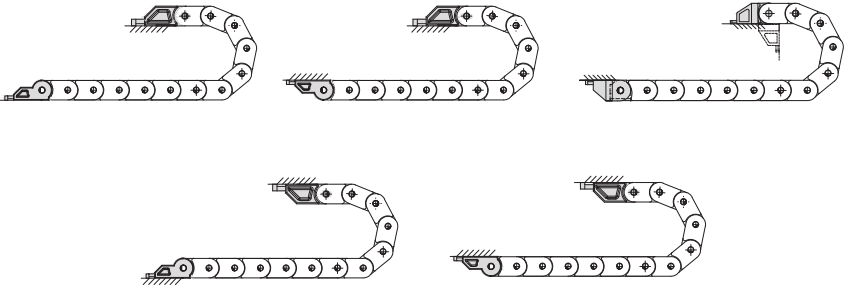

Montaj-Demontaj Uygulaması

Assembly-Disassembly Application

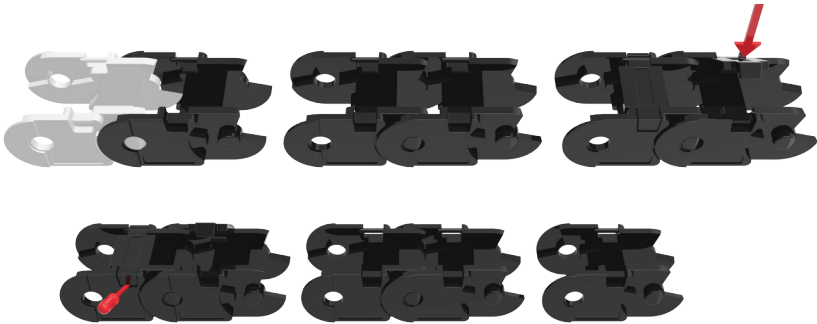

CK18



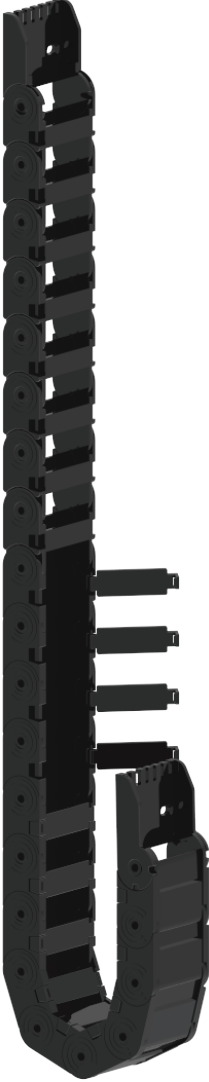

CK20 F SERİSİ Sabit Çıta
CK20 F SERIE Fixed Frame

CK20 Y SERİSİ İçten Açılabilir
CK20 Y SERIE Openable From Inner Side

MALZEME ÖZELLİKLERİ
MATERIAL FEATURES

PA6 %30 Cam Elyaf | PA6 With %30 Fiber Glass

MAKSİMUM ÇALIŞMA MESAFESİ
MAX TRAVEL DISTANCE

40 metre | 40 meter

HIZ
MAX SPEED

9 m/sn | 9 m/sec

ÇALIŞMA SICAKLIĞI
OPERATING TEMPERATURE

-30°C ~ + 130°C

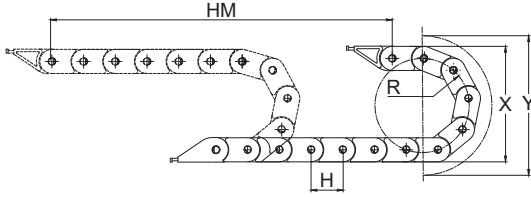

L Kullanılacak Miktar
Calculation of the Chain Length

HM Hareket Mesafesi
Movement Distance

X Montaj Yüksekliği
Mounting Height

Y Radyüs Mesafesi
Radius Distance

H Hatve
Pitch

$$L = HM / 2 + Y$$

$$X = R \times 2 + C$$

$$Y = R \times \pi$$

Kıvrılma Yarıçapı / Bending Radius

40

H (mm)

33

X (mm)

106

Y (mm)

126

YÜK DİYAGRAMI LOAD DIAGRAM

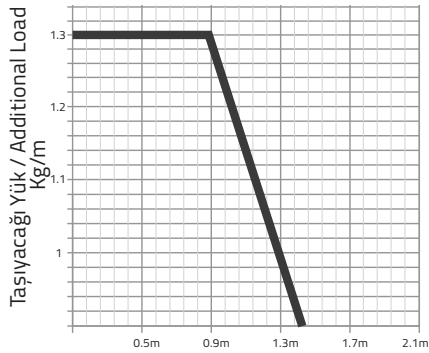

Desteksiz Mesafe / Unsupported Length

CK20 F SERİSİ

Sabit Çıta
Fixed Frame

CK20 F SERIE

Örnek Ürün Kodu
Product No. Example

CK20

İç Yükseklik
Inner Height

F

Sabit Çıta
Fixed Frame

025

İç Genişlik
Inner Width

R040

Kıvrılma Yarıçapı
Bending Radius

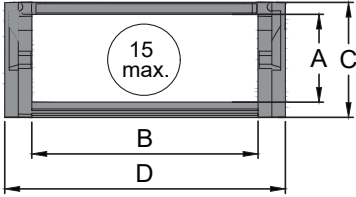

CK20 F	A	B	C	D	R	W
MODEL	İç Yükseklik (mm) <i>Inner Height (mm)</i>	İç Genişlik (mm) <i>Inner Width (mm)</i>	Dış Yükseklik (mm) <i>Outer Height (mm)</i>	Dış Genişlik (mm) <i>Outer Width (mm)</i>	Kıvrılma Yarıçapı <i>Bending Radius</i>	Ağırlık Kg/Mt <i>Weight Kg/Mt</i>
CK20 F 025 R 040	20	25	26	37	40	0,425



CK20 Y SERİSİ

CK20 Y SERIE

İçten Açılabilir Çıta
Openable From Inner Side

Örnek Ürün Kodu
Product No. Example

CK20

İç Yükseklik
Inner Height

Y

İçten Açılabilir
Openable From Inner Side

040

İç Genişlik
Inner Width

R040

Kıvrılma Yarıçapı
Bending Radius

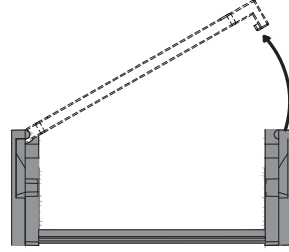
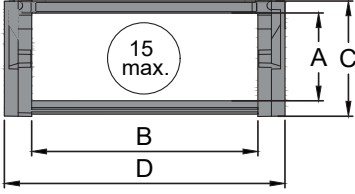

CK20 Y	A	B	C	D	R	W
MODEL	İç Yükseklik (mm) Inner Height (mm)	İç Genişlik (mm) Inner Width (mm)	Dış Yükseklik (mm) Outer Height (mm)	Dış Genişlik (mm) Outer Width (mm)	Kıvrılma Yarıçapı Bending Radius	Ağırlık Kg/Mt Weight Kg/Mt
CK20 Y 025 R 040	20	25	26	37	40	0,470
CK20 Y 040 R 040	20	40	26	52	40	0,543
CK20 Y 050 R 040	20	50	26	62	40	0,600
CK20 Y 060 R 040	20	60	26	72	40	0,634

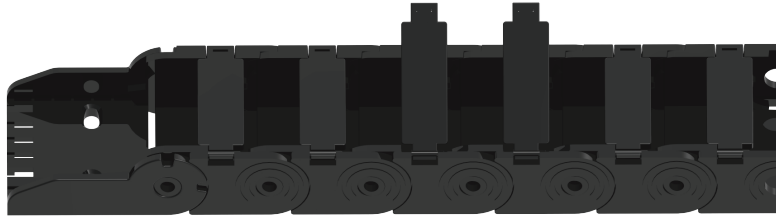

Plastik Ayak Montaj Ölçüleri
Plastic End Bracket Assembly Dimensions

CK20 P

CK20 P

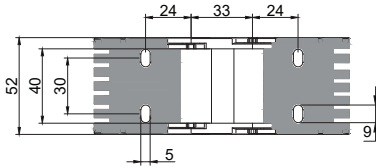

CK20 F



CK20 Y



CK20 P25

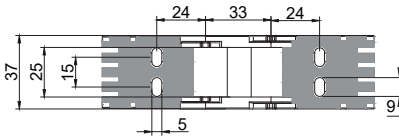

CK20 P40

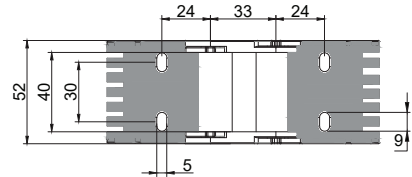

CK20 P50

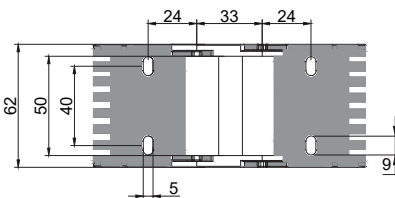

CK20 P60

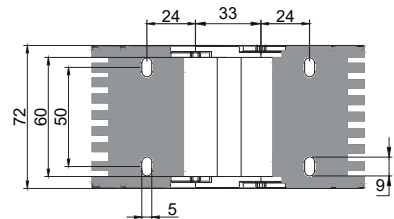

Plastik Ayak Bağlantı Şekilleri *Plastic End Bracket Assembly*

CK20 P

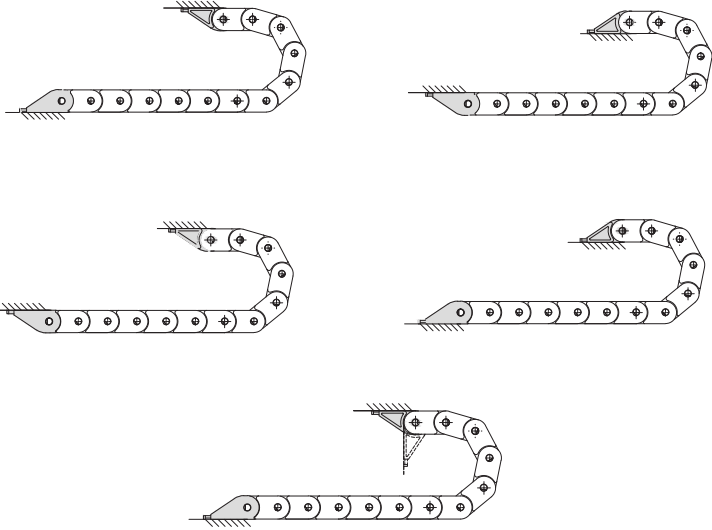

Montaj-Demontaj Uygulaması *Assembly-Disassembly Application*

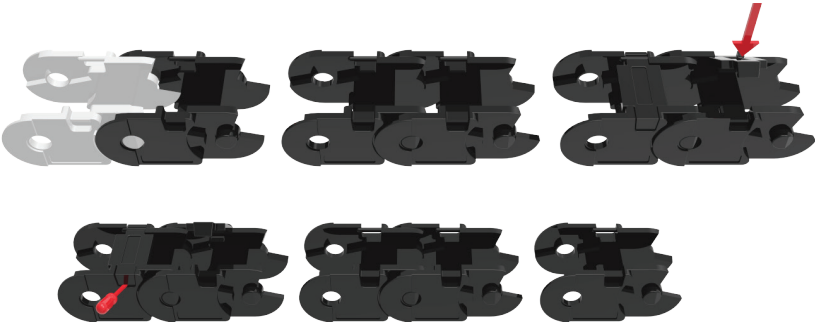

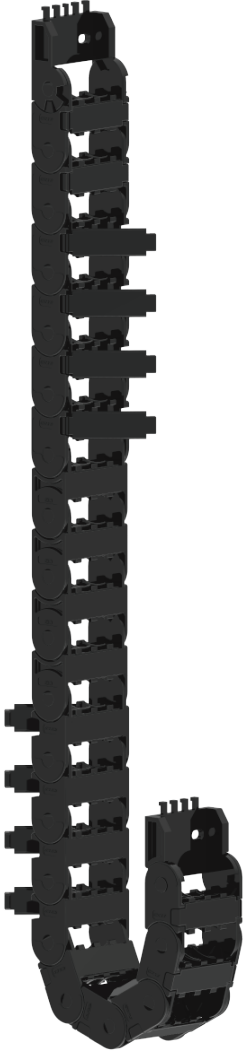

CK24 A SERİSİ içten Açılabilir
CK24 A SERIE Openable From Inner Side

CK24 B SERİSİ Dıştan Açılabilir
CK24 B SERIE Openable From Outside

CK24 F SERİSİ Sabit Çıta
CK24 F SERIE Fixed Frame

MALZEME ÖZELLİKLERİ
MATERIAL FEATURES

PA6 %30 Cam Elyaf | PA6 With %30 Fiber Glass

MAKSİMUM ÇALIŞMA MESAFESİ
MAX TRAVEL DISTANCE

60 metre | 60 meter

HIZ
MAX SPEED

9 m/sn | 9 m/sec

ÇALIŞMA SICAKLIĞI
OPERATING TEMPERATURE

-30°C ~ + 130°C

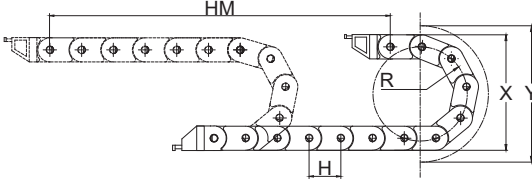

- L** Kullanılacak Miktar
Calculation of the Chain Length
- HM** Hareket Mesafesi
Movement Distance
- X** Montaj Yüksekliği
Mounting Height
- Y** RADIUS Mesafesi
Radius Distance
- H** Hatve
Pitch

$$L = HM / 2 + Y$$

$$X = R \times 2 + C$$

$$Y = R \times \pi$$

Kıvrılma Yarıçapı / <i>Bending Radius</i>	40	75	100	125
H (mm)	44	44	44	44
X (mm)	112	182	232	282
Y (mm)	126	236	314	393

YÜK DİYAGRAMI *LOAD DIAGRAM*

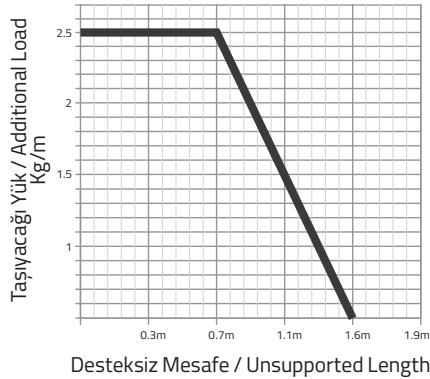

CK24 A SERİSİ

CK24A SERIE

İçten Açılabilir Çıta
Openable From Innerside

Örnek Ürün Kodu
Product No. Example

CK24

İç Yükseklik
Inner Height

A

İçten Açılabilir
Openable From Inside

025

İç Genişlik
Inner Width

R040

Kıvrılma Yarıçapı
Bending Radius

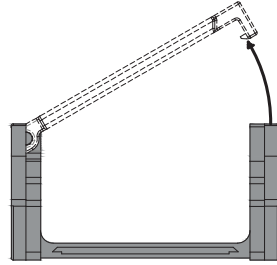
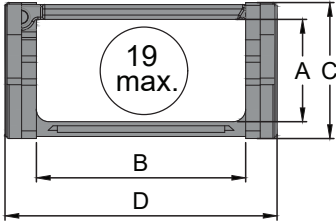

CK24 A	A	B	C	D	R	W
MODEL	İç Yükseklik (mm) Inner Height (mm)	İç Genişlik (mm) Inner Width (mm)	Dış Yükseklik (mm) Outer Height (mm)	Dış Genişlik (mm) Outer Width (mm)	Kıvrılma Yarıçapı Bending Radius	Ağırlık Kg/Mt Weight Kg/Mt
CK24 A 025 R ...	24	25	32	40	40, 75, 100, 125	0,582
CK24 A 040 R ...	24	40	32	55		0,621
CK24 A 050 R ...	24	50	32	65		0,658
CK24 A 060 R ...	24	60	32	75		0,668

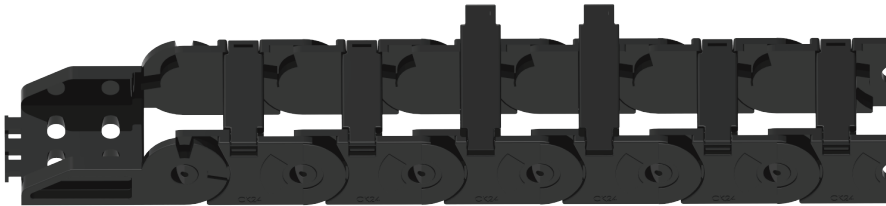

Plastik Dikey Seperator Ölçüleri

Plastic Vertical Seperator Dimensions

CK24 A SP

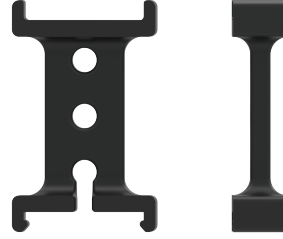
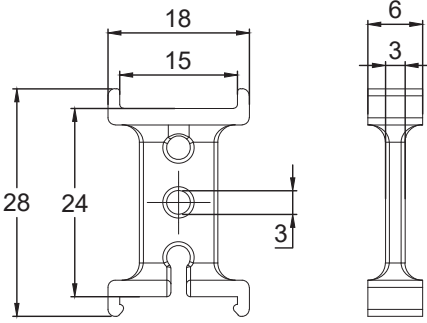

Plastik Ayak Bağlantı Şekilleri

Plastic End Bracket Assembly

CK24 P

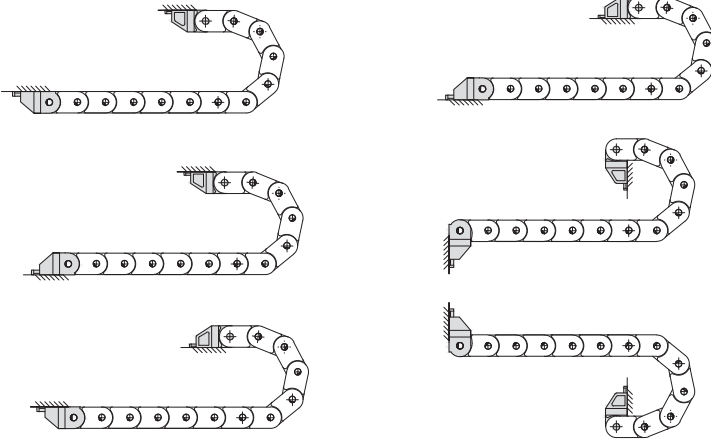

Plastik Ayak Montaj Ölçüleri Plastic End Bracket Assembly Dimensions

CK24 A P

CK24 P

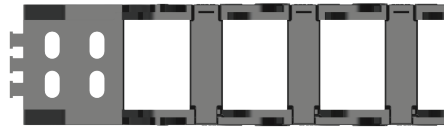
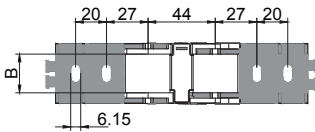

CK24 P025

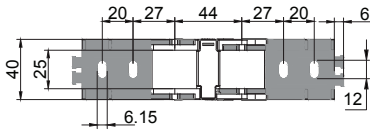

CK24 P040

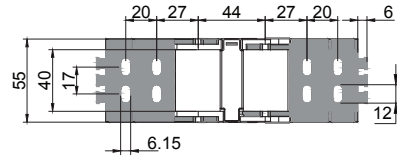

CK24 P050

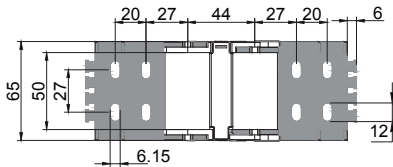

CK24 P060

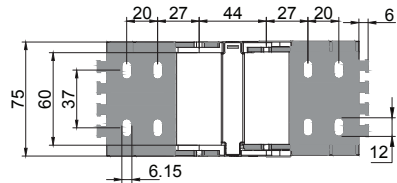

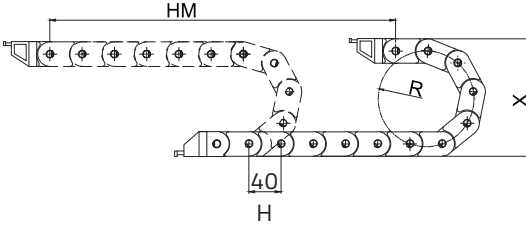

L Kullanılacak Miktar
Calculation of the Chain Length

HM Hareket Mesafesi
Movement Distance

X Montaj Yüksekliği
Mounting Height

Y Radyüs Mesafesi
Radius Distance

H Hatve
Pitch

$$L = HM / 2 + Y$$

$$X = R \times 2 + C$$

$$Y = R \times \pi$$

Kıvrılma Yarıçapı / Bending Radius	40	75	100	125
H (mm)	40	40	40	40
X (mm)	110	180	230	280
Y (mm)	126	236	314	393

YÜK DİYAGRAMI LOAD DIAGRAM

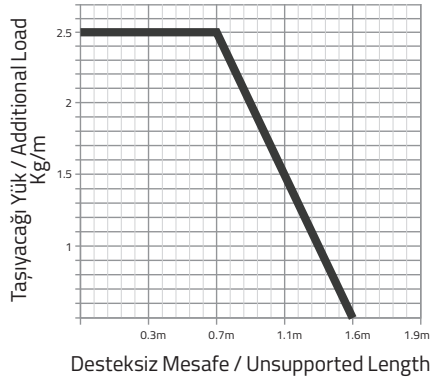

CK24 B SERİSİ

CK24 B SERIE

Diştan Açılabilir Çıta
Openable From Outside

Örnek Ürün Kodu
Product No. Example

CK24

İç Yükseklik
Inner Height

B

Diştan Açılabilir
Openable From Outside

040

İç Genişlik
Inner Width

R075

Kıvrılma Yarıçapı
Bending Radius

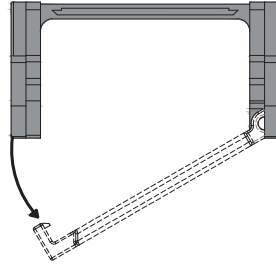
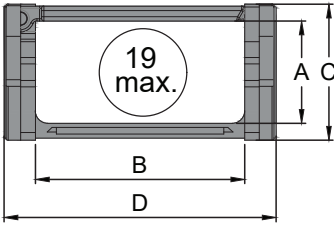

CK24 B	A	B	C	D	R	W
MODEL	İç Yükseklik (mm) Inner Height (mm)	İç Genişlik (mm) Inner Width (mm)	Diş Yükseklik (mm) Outer Height (mm)	Diş Genişlik (mm) Outer Width (mm)	Kıvrılma Yarıçapı Bending Radius	Ağırlık Kg/Mt Weight Kg/Mt
CK24 B 025 R ...	24	25	30	38	40, 75, 100, 125	0,495
CK24 B 040 R ...	24	40	30	53		0,545
CK24 B 048 R ...	24	48	30	61		0,573
CK24 B 060 R ...	24	60	30	73		0,627
CK24 B 080 R ...	24	80	30	93		0,711

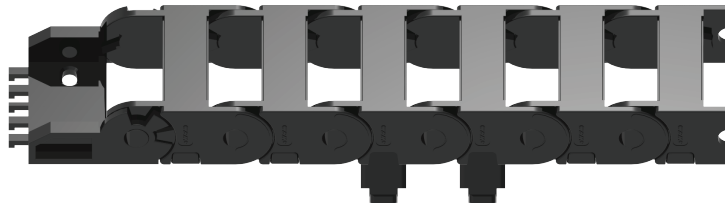

Plastik Ayak Montaj Ölçüleri Plastic End Bracket Assembly Dimensions

CK24B P

CK24 P

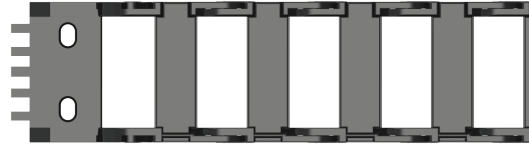
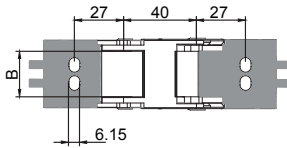

CK24 P025

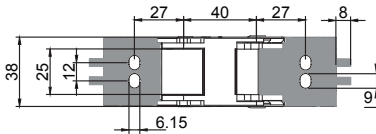

CK24 P040

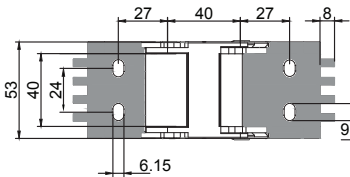

CK24 P048

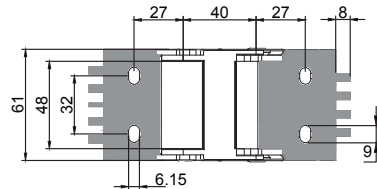

CK24 P060

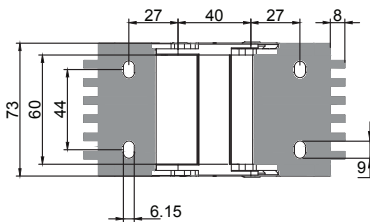

CK24 P080

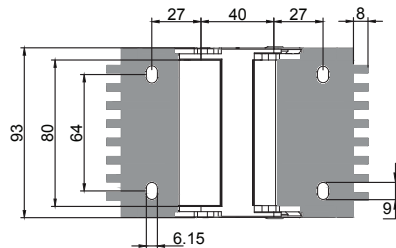

CK24 F SERİSİ

Sabit Çıta
Fixed Frame

CK24 F SERIE

Örnek Ürün Kodu
Product No. Example

CK24

İç Yükseklik
Inner Height

F

Sabit Çıta
Fixed Frame

048

İç Genişlik
Inner Width

R075

Kıvrılma Yarıçapı
Bending Radius

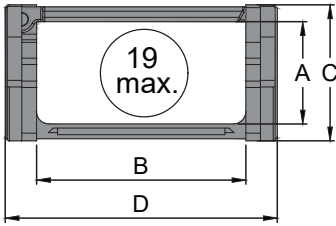

CK24 F	A	B	C	D	R	W
MODEL	İç Yükseklik (mm) Inner Height (mm)	İç Genişlik (mm) Inner Width (mm)	Dış Yükseklik (mm) Outer Height (mm)	Dış Genişlik (mm) Outer Width (mm)	Kıvrılma Yarıçapı Bending Radius	Ağırlık Kg/Mt Weight Kg/Mt
CK24 F 018 R ...	24	18	30	31	40, 75, 100, 125	0,465
CK24 F 048 R ...	24	48	30	61		0,573



Plastik Ayak Montaj Ölçüleri Plastic End Bracket Assembly Dimensions

CK24 P

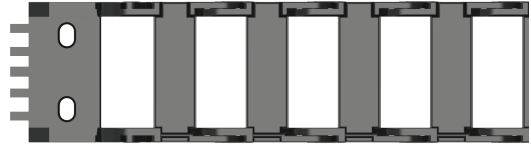
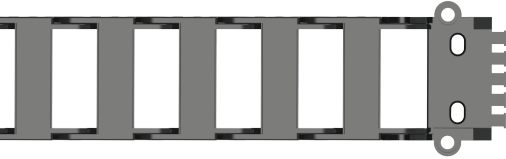

CK24 P

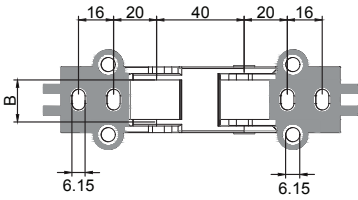

CK24 P

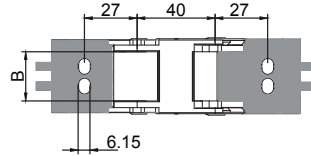

CK24 P018

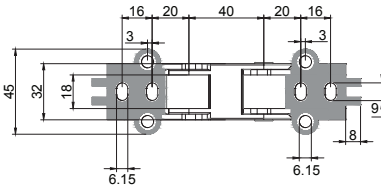

CK24 P048

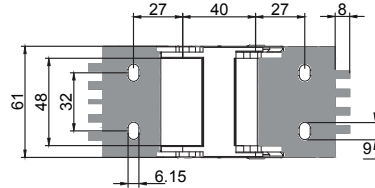

CK24 P048

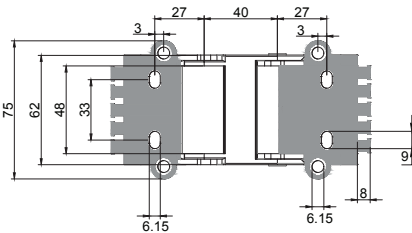

Plastik Dikey Seperatör Ölçüleri

Plastic Vertical Separator Dimensions

CK24 B-F SP

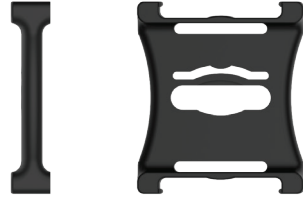
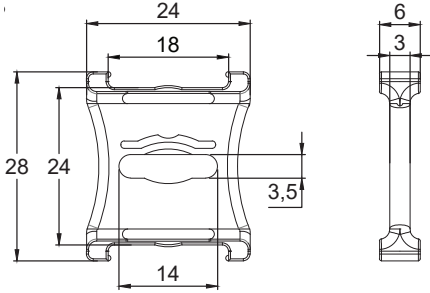

Plastik Yatay Seperatör Ölçüleri

Plastic Horizontal Separator Dimensions

CK24 B-F YSP

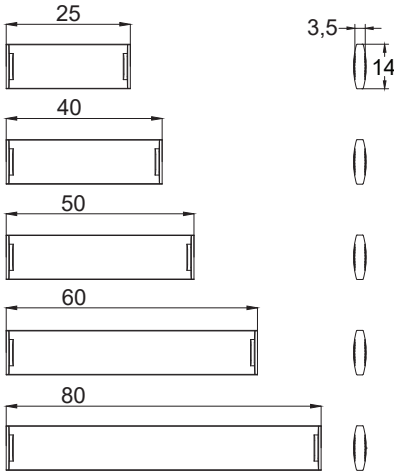

CK24 B-F

Plastik Ayak Bağlantı Şekilleri Plastic End Bracket Assembly

CK24 P

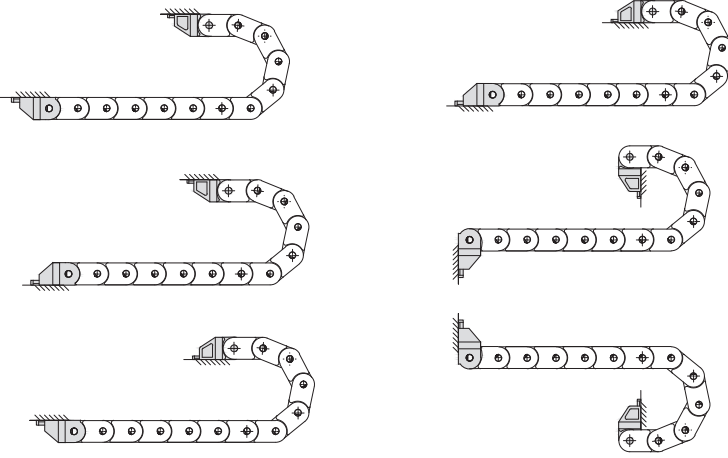

Montaj-Demontaj Uygulaması Assembly-Disassembly Application

