



CK40 A-AL-K-Y SERİSİ

CK40 A-AL-K-Y SERIE

CK60 A-AL-K-Y SERİSİ

CK60 A-AL-K-Y SERIE

CK80 A-AL SERİSİ

CK80 A-AL SERIE

CK110 AL-K-Y SERİSİ

CK110 AL-K-Y SERIE

PLASTİK AĞIR SERİ
PLASTIC HEAVY SERIE

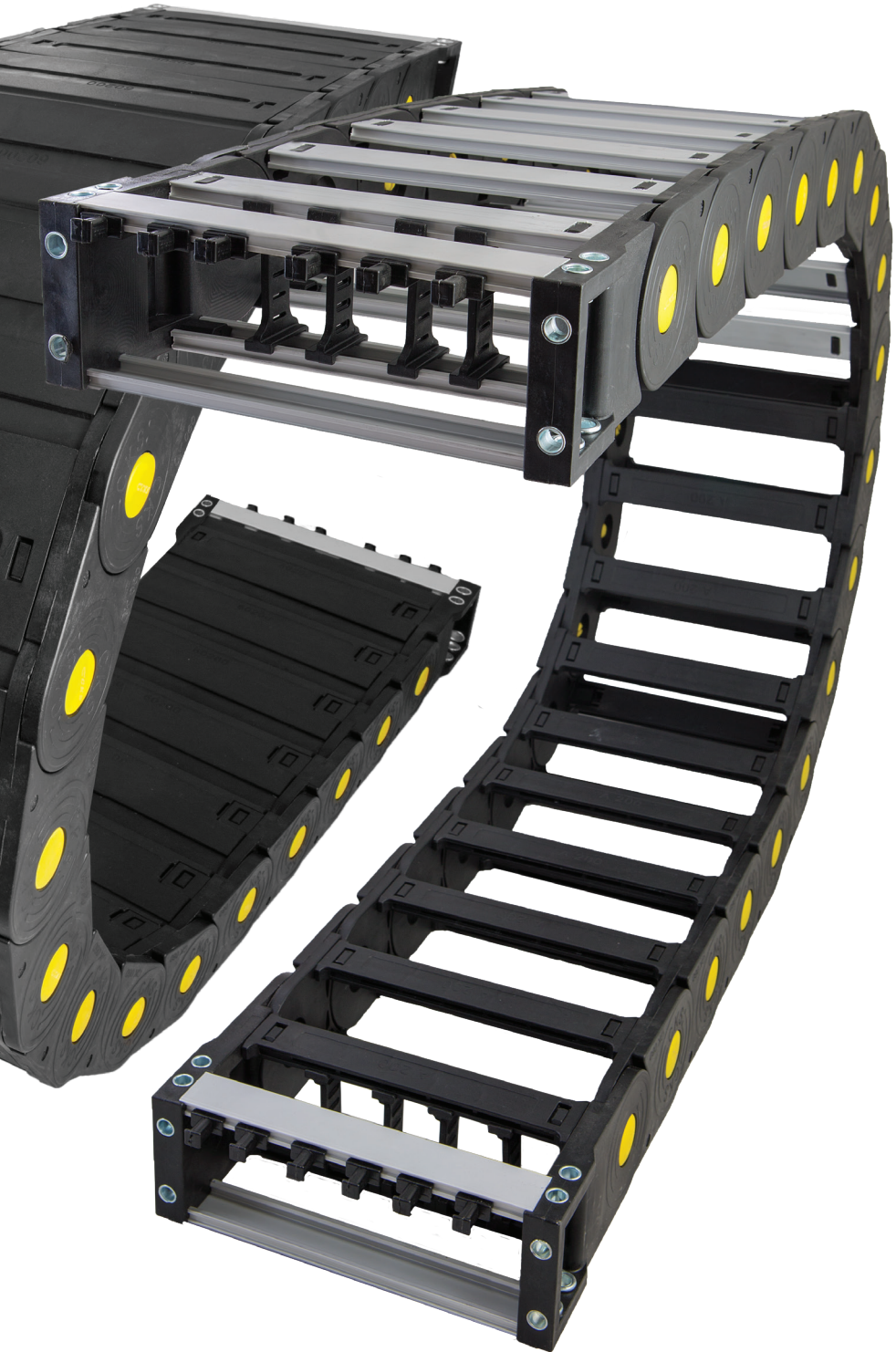



CK40 A SERİSİ Plastik Açık Çıta
CK40 A SERIE Plastic Open Frame

CK40 AL SERİSİ Alüminyum Açık Çıta
CK40 AL SERIE Aluminium Open Frame

CK40 K SERİSİ Kapalı Kapak
CK40 K SERIE Closed Cover

CK40 Y SERİSİ Yarı Kapalı Kapak
CK40 Y SERIE Half Covered

MALZEME ÖZELLİKLERİ
MATERIAL FEATURES

PA6 %30 Cam Elyaf | PA6 With %30 Fiber Glass

MAKSİMUM ÇALIŞMA MESAFESİ
MAX TRAVEL DISTANCE

120 metre | 120 meter

HIZ
MAX SPEED

5 m/sn | 5 m/sec

ÇALIŞMA SICAKLIĞI
OPERATING TEMPERATURE

-30°C ~ + 130°C

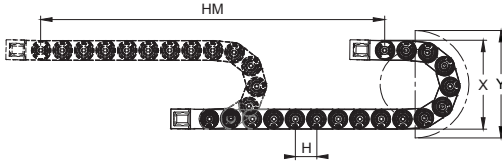

- L** Kullanılacak Miktar
Calculation of the Chain Length
- HM** Hareket Mesafesi
Movement Distance
- X** Montaj Yüksekliği
Mounting Height
- Y** Radyüs Mesafesi
Radius Distance
- H** Hatve
Pitch

$$L = HM / 2 + Y$$

$$X = R \times 2 + C$$

$$Y = R \times \pi$$

Kıvrılma Yarıçapı / Bending Radius	75	100	125	150	200	250	300
H (mm)	72	72	72	72	72	72	72
X (mm)	212	262	312	362	462	562	662
Y (mm)	236	314	392	471	628	785	942

* Kapalı ve Yarı Açık serilerin radiusleri 125'ten başlamaktadır /
The Closed Cover and Half Covered type product radius is started from R125

YÜK DİYAGRAMI LOAD DIAGRAM

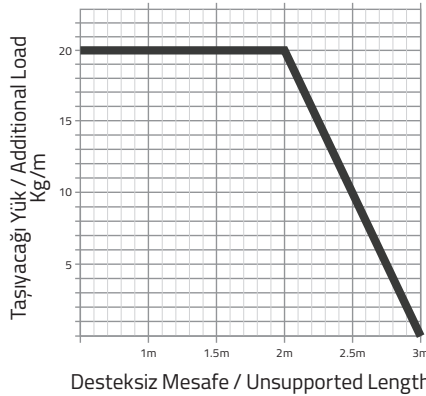

CK40 A SERİSİ

İçten ve Dıştan Açılabilir Çıta
Openable From Inner and Outside

CK40 A SERIE

Örnek Ürün Kodu
Product No. Example

CK40

İç Yükseklik
Inner Height

A

Açık Seri
Open Serie

080

İç Genişlik
Inner Width

R100

Kıvrılma Yarıçapı
Bending Radius

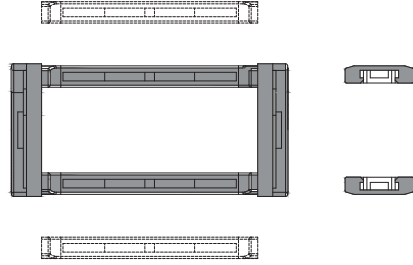
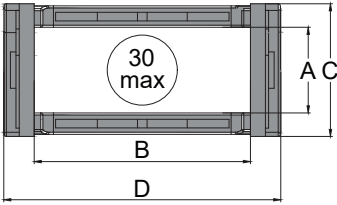

CK 40 A	A	B	C	D	R	W
MODEL	İç Yükseklik (mm) Inner Height (mm)	İç Genişlik (mm) Inner Width (mm)	Dış Yükseklik (mm) Outer Height (mm)	Dış Genişlik (mm) Outer Width (mm)	Kıvrılma Yarıçapı Bending Radius	Ağırlık Kg/Mt Weight Kg/Mt
CK40 A 080 R ...	40	80	62	108	75, 100, 125, 150, 200, 250, 300	2,348
CK40 A 100 R ...		100		128		2,516
CK40 A 120 R ...		120		148		2,684
CK40 A 140 R ...		140		168		2,824
CK40 A 160 R ...		160		188		2,936
CK40 A 180 R ...		180		208		3,048
CK40 A 200 R ...		200		228		3,272

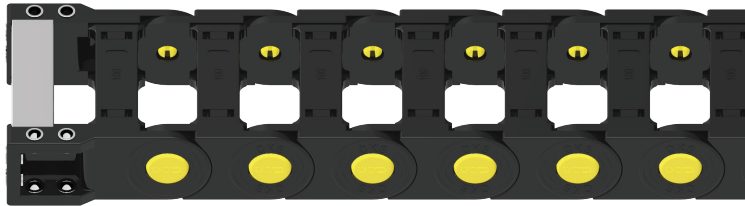

CK40 AL SERİSİ

CK40 AL SERIE

İçten ve Dıştan Açılabilir Çıta
Openable From Inner and Outside

Örnek Ürün Kodu
Product No. Example

CK40

İç Yükseklik
Inner Height

AL

Alüminyum Çıta
Aluminium Frame

500

İç Genişlik
Inner Width

R300

Kıvrılma Yarıçapı
Bending Radius

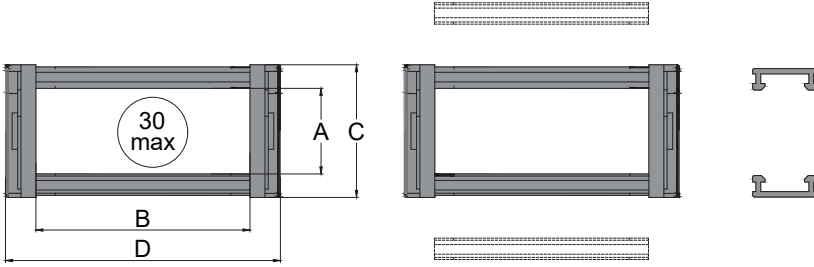

CK 40 AL	A	B	C	D	R	W
MODEL	İç Yükseklik (mm) Inner Height (mm)	İç Genişlik (mm) Inner Width (mm)	Dış Yükseklik (mm) Outer Height (mm)	Dış Genişlik (mm) Outer Width (mm)	Kıvrılma Yarıçapı Bending Radius	Ağırlık Kg/Mt Weight Kg/Mt
CK40 AL 250 R ...	40	250	62	278	75, 100, 125, 150, 200, 250, 300	3,552
CK40 AL 300 R ...		300		3,888		
CK40 AL 400 R ...		400		4,560		
CK40 AL 500 R ...		500		5,232		

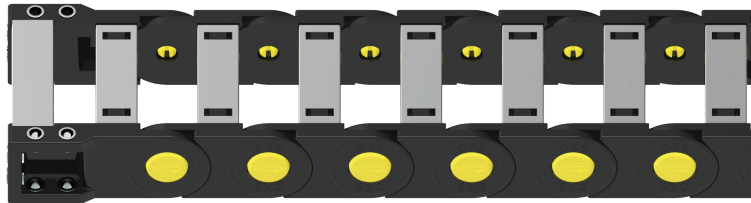

CK40 K SERİSİ

İçten ve Dıştan Açılabilir Kapak
Openable From Inner and Outside

CK40 K SERIE

Örnek Ürün Kodu
Product No. Example

CK40

İç Yükseklik
Inner Height

K

Kapalı Seri
Closed Serie

100

İç Genişlik
Inner Width

R250

Kıvrılma Yarıçapı
Bending Radius

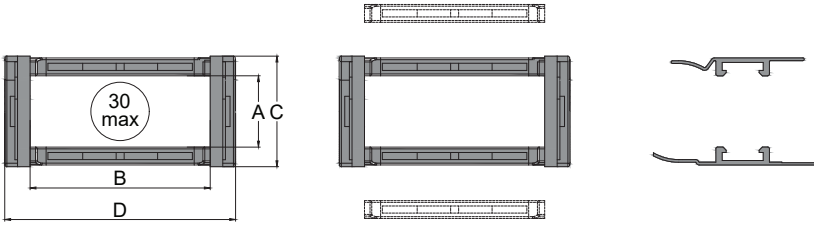

CK 40 K	A	B	C	D	R	W
MODEL	İç Yükseklik (mm) Inner Height (mm)	İç Genişlik (mm) Inner Width (mm)	Dış Yükseklik (mm) Outer Height (mm)	Dış Genişlik (mm) Outer Width (mm)	Kıvrılma Yarıçapı Bending Radius	Ağırlık Kg/Mt Weight Kg/Mt
CK40 K 100 R ...	40	100	62	128	125, 150, 200, 250, 300	2,810

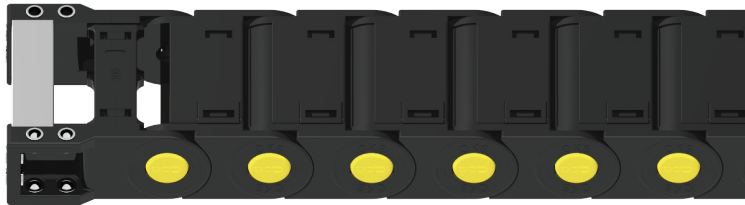

CK40 Y SERİSİ

CK40 Y SERIE

İçten ve Dıştan Açılabilir Kapak
Openable From Inner and Outside

Örnek Ürün Kodu
Product No. Example

CK40

İç Yükseklik
Inner Height

Y

Yarı Açık Seri
Half Covered Serie

100

İç Genişlik
Inner Width

R250

Kıvrılma Yarıçapı
Bending Radius

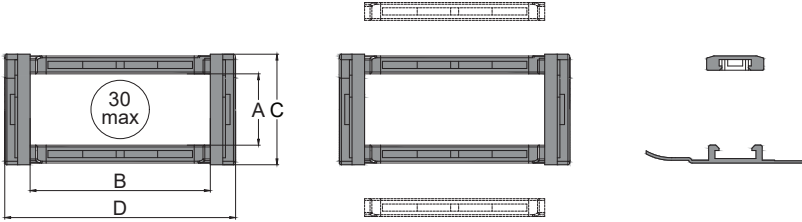

CK 40 Y	A	B	C	D	R	W
MODEL	İç Yükseklik (mm) Inner Height (mm)	İç Genişlik (mm) Inner Width (mm)	Dış Yükseklik (mm) Outer Height (mm)	Dış Genişlik (mm) Outer Width (mm)	Kıvrılma Yarıçapı Bending Radius	Ağırlık Kg/Mt Weight Kg/Mt
CK40 Y 100 R ...	40	100	62	128	125, 150, 200, 250, 300	2,600



Dikey Separatör Ölçüleri
Vertical Separator Dimensions

CK40 SP

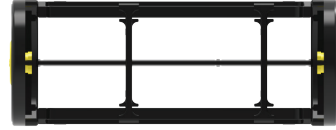
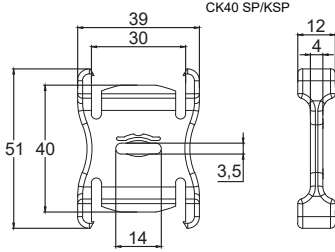

Yatay Separatör Ölçüleri
Horizontal Separator Dimensions

CK40 YSP

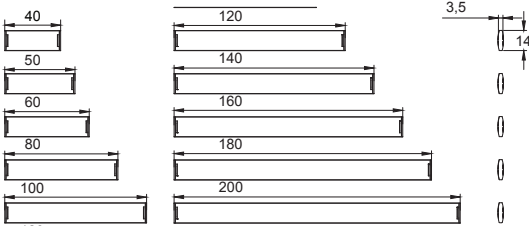

Plastik Ayak Montaj Ölçüleri

Plastic End Bracket Assembly Dimensions

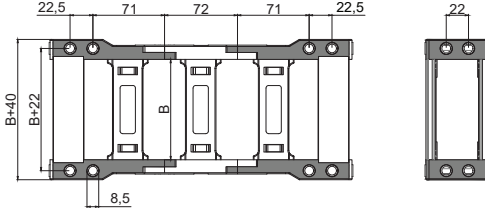

'B' ölçüsünü ölçü tablosundan bulabilirsiniz.
You will find the 'B' dimension from model table.

CK40 NP

CK40 NPA

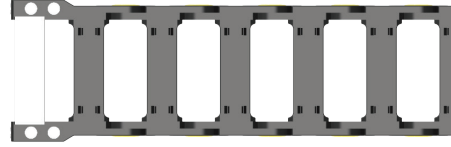

CK40 NPK



CK40 NPY

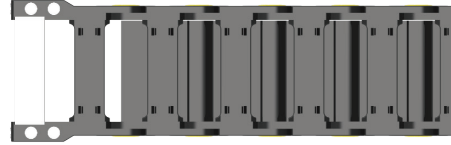

CK40 NPAL



Plastik Ayak Montaj

Plastic End Bracket Assembly



Metal Ayak Montaj Ölçüleri

Metal End Bracket Assembly Dimensions

CK40 M

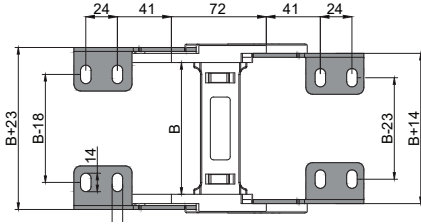

'B' ölçüsünü ölçü tablosundan bulabilirsiniz.
You will find the 'B' dimension from model table.

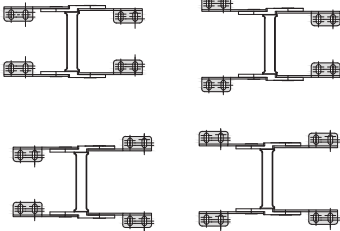

CK40 A



CK40 AL



CK40 K

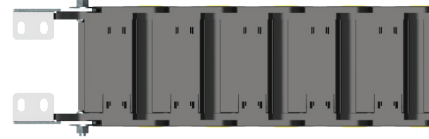

CK40 Y

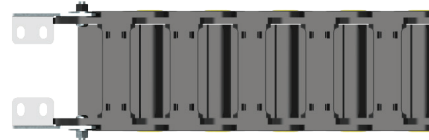

Metal Ayak Montaj

Metal End Bracket Assembly

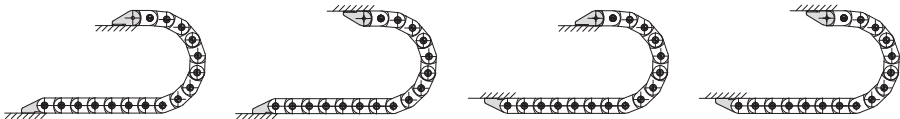

Montaj Uygulaması

Assembly Application

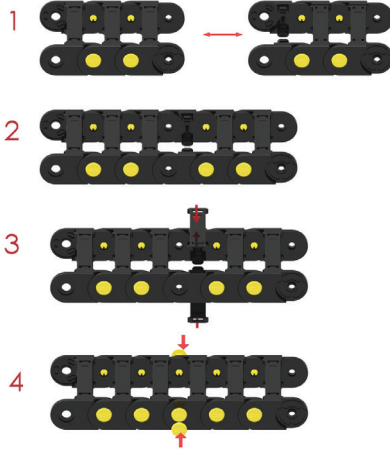

Demontaj Uygulaması

Disassembly Application

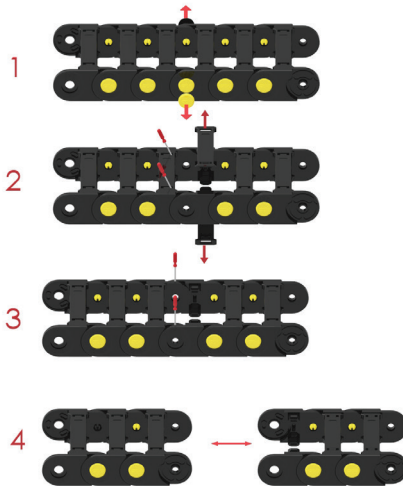



CK60 A SERİSİ Plastik Açık Çıta
CK60 A SERIE Plastic Open Frame

CK60 AL SERİSİ Alüminyum Açık Çıta
CK60 AL SERIE Aluminium Open Frame

CK60 K SERİSİ Kapalı Kapak
CK60 K SERIE Closed Cover

CK60 Y SERİSİ Yarı Kapalı Kapak
CK60 Y SERIE Half Covered

MALZEME ÖZELLİKLERİ
MATERIAL FEATURES

PA6 %30 Cam Elyaf | PA6 With %30 Fiber Glass

MAKSİMUM ÇALIŞMA MESAFESİ
MAX TRAVEL DISTANCE

120 metre | 120 meter

HIZ

MAX SPEED

4 m/sn | 4 m/sec

ÇALIŞMA SICAKLIĞI

OPERATING TEMPERATURE

-30°C ~ + 130°C

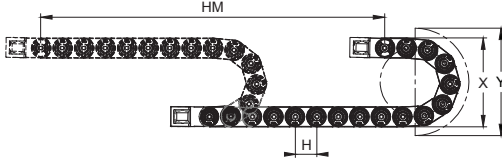

- L** Kullanılacak Miktar
Calculation of the Chain Length
- HM** Hareket Mesafesi
Movement Distance
- X** Montaj Yüksekliği
Mounting Height
- Y** Radüs Mesafesi
Radius Distance
- H** Hatve
Pitch

$$L = HM / 2 + Y$$

$$X = R \times 2 + C$$

$$Y = R \times \pi$$

Kıvrılma Yarıçapı / Bending Radius	100	150	200	250	300
H (mm)	91	91	91	91	91
X (mm)	282	382	482	582	682
Y (mm)	314	471	628	785	942

* Kapalı ve Yarı Açık serilerin radiusleri 150'den başlamaktadır /
The Closed Cover and Half Covered type product radius is started from R150

YÜK DİYAGRAMI LOAD DIAGRAM

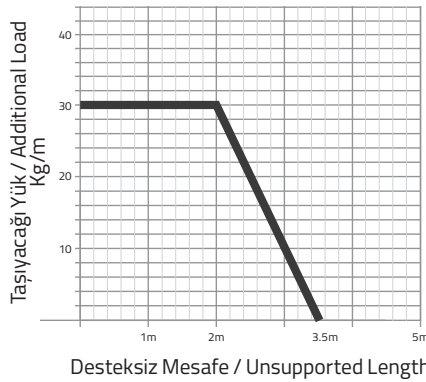

CK60 A SERİSİ

CK60 A SERIE

İçten ve Dıştan Açılabilir Çıta
Openable From Inner and Outside

Örnek Ürün Kodu
Product No. Example

CK60

İç Yükseklik
Inner Height

A

Açık Seri
Open Serie

080

İç Genişlik
Inner Width

R100

Kıvrılma Yarıçapı
Bending Radius

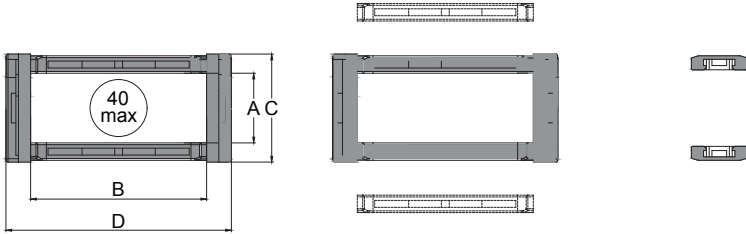

CK 60 A	A	B	C	D	R	W
MODEL	İç Yükseklik (mm) <i>Inner Height (mm)</i>	İç Genişlik (mm) <i>Inner Width (mm)</i>	Dış Yükseklik (mm) <i>Outer Height (mm)</i>	Dış Genişlik (mm) <i>Outer Width (mm)</i>	Kıvrılma Yarıçapı <i>Bending Radius</i>	Ağırlık Kg/Mt <i>Weight Kg/Mt</i>
CK60 A 080 R ...	60	80	82	112	100, 150, 200, 250, 300	3,120
CK60 A 100 R ...		100		132		3,252
CK60 A 120 R ...		120		152		3,384
CK60 A 140 R ...		140		172		3,494
CK60 A 160 R ...		160		192		3,582
CK60 A 180 R ...		180		212		3,670
CK60 A 200 R ...		200		232		3,846

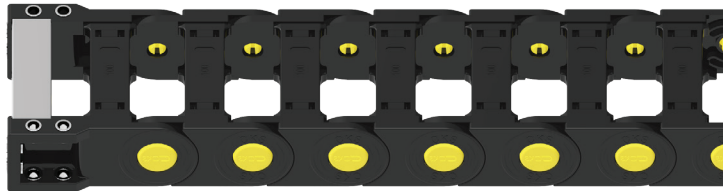

CK60 AL SERİSİ

CK60 AL SERIE

İçten ve Dıştan Açılabilir Çıta
Openable From Inner and Outside

Örnek Ürün Kodu
Product No. Example

CK60

İç Yükseklik
Inner Height

AL

Alüminyum Çıta
Aluminium Frame

500

İç Genişlik
Inner Width

R300

Kıvrılma Yarıçapı
Bending Radius

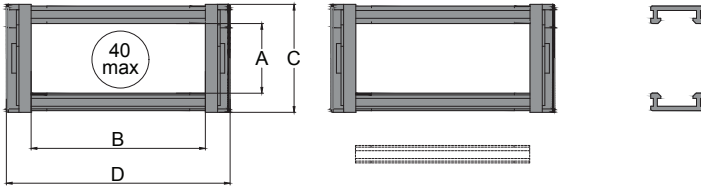

CK 60 AL	A	B	C	D	R	W
MODEL	İç Yükseklik (mm) Inner Height (mm)	İç Genişlik (mm) Inner Width (mm)	Dış Yükseklik (mm) Outer Height (mm)	Dış Genişlik (mm) Outer Width (mm)	Kıvrılma Yarıçapı Bending Radius	Ağırlık Kg/Mt Weight Kg/Mt
CK60 AL 250 R ...	60	250	82	282	100, 150, 200, 250, 300	4,065
CK60 AL 300 R ...		300		332		4,330
CK60 AL 400 R ...		400		432		4,858
CK60 AL 500 R ...		500		532		5,386

Seçenek 1
Option 1

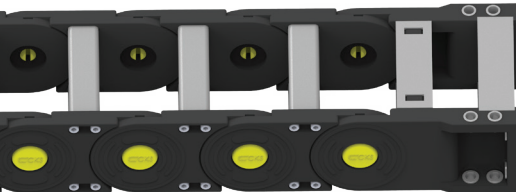

Seçenek 2
Option 2

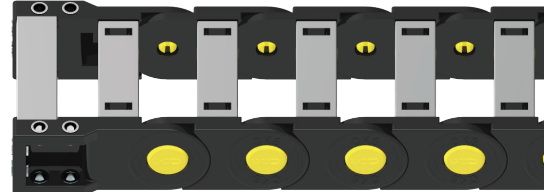

CK60 K SERİSİ

CK60 K SERIE

İçten ve Dıştan Açılabilir Kapak
Openable From Inner and Outside

Örnek Ürün Kodu
Product No. Example

CK60

İç Yükseklik
Inner Height

K

Kapalı Seri
Closed Cover

100

İç Genişlik
Inner Width

R250

Kıvrılma Yarıçapı
Bending Radius

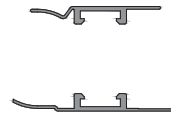
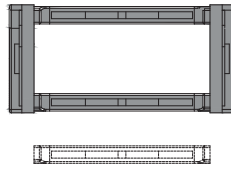
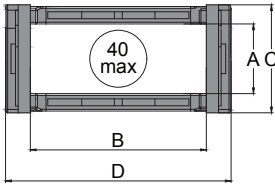

CK 60 K	A	B	C	D	R	W
MODEL	İç Yükseklik (mm) Inner Height (mm)	İç Genişlik (mm) Inner Width (mm)	Dış Yükseklik (mm) Outer Height (mm)	Dış Genişlik (mm) Outer Width (mm)	Kıvrılma Yarıçapı Bending Radius	Ağırlık Kg/Mt Weight Kg/Mt
CK60 K 100 R ...	60	100	82	132		3,681
CK60 K 140 R ...	60	140	82	172	150, 200, 250, 300	4,088
CK60 K 200 R ...	60	200	82	232		4,649



CK60 Y SERİSİ

CK60 Y SERIE

İçten ve Dıştan Açılabilir Kapak
Openable From Inner and Outside

Örnek Ürün Kodu
Product No. Example

CK60

İç Yükseklik
Inner Height

Y

Yarı Açık Seri
Half Covered

100

İç Genişlik
Inner Width

R250

Kıvrılma Yarıçapı
Bending Radius

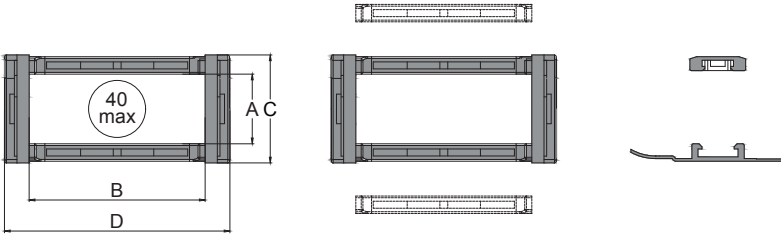

CK 60 Y	A	B	C	D	R	W
MODEL	İç Yükseklik (mm) Inner Height (mm)	İç Genişlik (mm) Inner Width (mm)	Dış Yükseklik (mm) Outer Height (mm)	Dış Genişlik (mm) Outer Width (mm)	Kıvrılma Yarıçapı Bending Radius	Ağırlık Kg/Mt Weight Kg/Mt
CK60 Y 100 R ...	60	100	82	132		3,417
CK60 Y 140 R ...	60	140	82	172	150, 200, 250, 300	3,736
CK60 Y 200 R ...	60	200	82	232		4,220



Dikey Separatör Ölçüleri
Vertical Separator Dimensions

CK60 SP

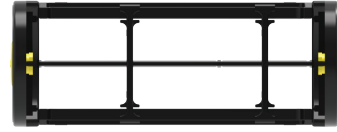
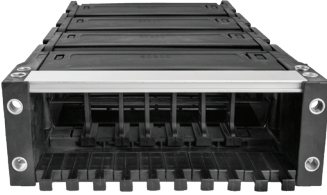
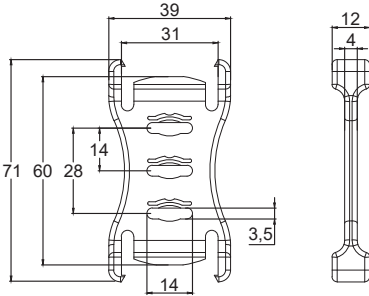

Yatay Separatör Ölçüleri
Horizontal Separator Dimensions

CK60 YSP

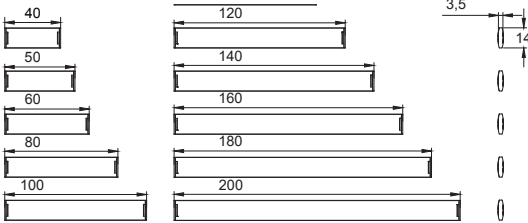

Plastik Ayak Montaj Ölçüleri

Plastic End Bracket Assembly Dimensions

CK60 NP

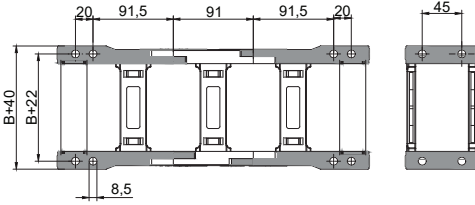

'B' ölçüsünü ölçü tablosundan bulabilirsiniz.
You will find the 'B' dimension from model table.

CK60 NPA

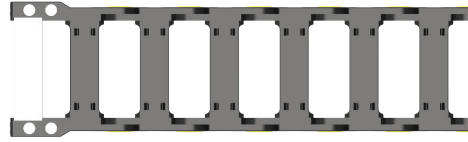

CK60 NPK



CK60 NPY

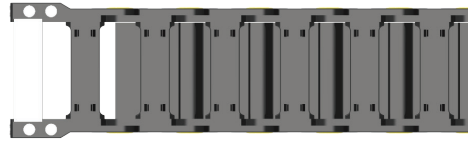

CK60 NPAL

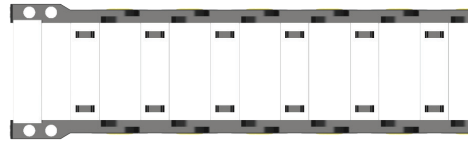

Plastik Ayak Montaj

Plastic End Bracket Assembly

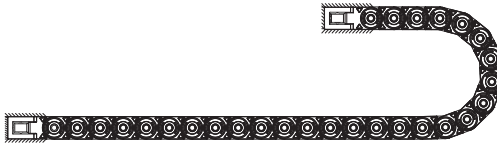

Metal Ayak Montaj Ölçüleri

Metal End Bracket Assembly Dimensions

CK60 M

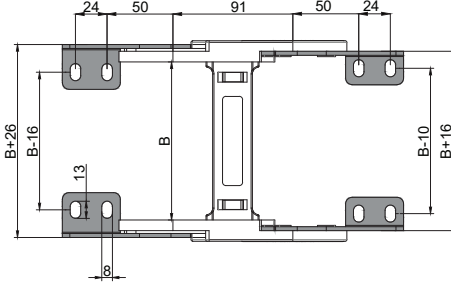

'B' ölçüsünü ölçü tablosundan bulabilirsiniz.
You will find the 'B' dimension from model table.

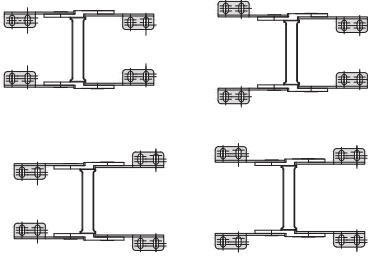

Metal Ayak Montaj

Metal End Bracket Assembly

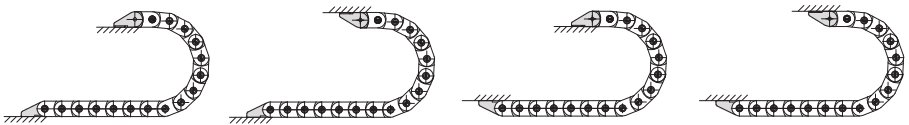

CK60 M



CK60 A

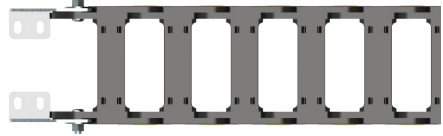

CK60 AL

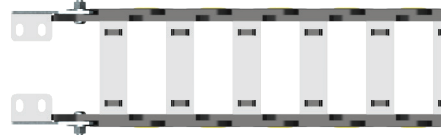

CK60 K



CK60 Y

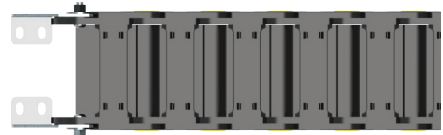



CK80 A SERİSİ Plastik Açık Çıta
CK80 A SERIE Plastic Open Frame

CK80 AL SERİSİ Alüminyum Açık Çıta
CK80 AL SERIE Aluminium Open Frame

MALZEME ÖZELLİKLERİ
MATERIAL FEATURES

PA6 %30 Cam Elyaf | PA6 With %30 Fiber Glass

MAKSİMUM ÇALIŞMA MESAFESİ
MAX TRAVEL DISTANCE

120 metre | 120 meter

HIZ
MAX SPEED

4 m/sn | 4 m/sec

ÇALIŞMA SICAKLIĞI
OPERATING TEMPERATURE

-30°C ~ + 130°C

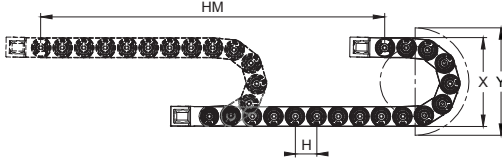

- L** Kullanılacak Miktar
Calculation of the Chain Length
- HM** Hareket Mesafesi
Movement Distance
- X** Montaj Yüksekliği
Mounting Height
- Y** Radüs Mesafesi
Radius Distance
- H** Hatve
Pitch

$$L = HM / 2 + Y$$

$$X = R \times 2 + C$$

$$Y = R \times \pi$$

Kıvrılma Yarıçapı / Bending Radius	150	200	250	300
H (mm)	110	110	110	110
X (mm)	402	502	602	702
Y (mm)	471	628	785	942

YÜK DİYAGRAMI LOAD DIAGRAM

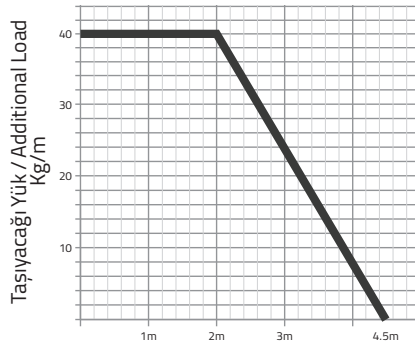

Desteksiz Mesafe / Unsupported Length

CK80 A SERİSİ

CK80 A SERIE

İçten ve Dıştan Açılabilir Çıta
Openable From Inner and Outside

Örnek Ürün Kodu
Product No. Example

CK80

İç Yükseklik
Inner Height

A

Açık Seri
Open Serie

200

İç Genişlik
Inner Width

R200

Kıvrılma Yarıçapı
Bending Radius

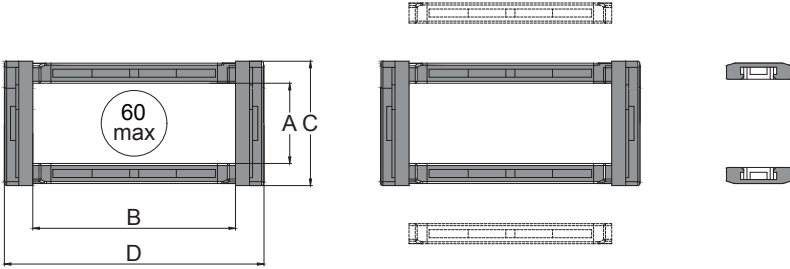

CK 80 A	A	B	C	D	R	W
MODEL	İç Yükseklik (mm) Inner Height (mm)	İç Genişlik (mm) Inner Width (mm)	Dış Yükseklik (mm) Outer Height (mm)	Dış Genişlik (mm) Outer Width (mm)	Kıvrılma Yarıçapı Bending Radius	Ağırlık Kg/Mt Weight Kg/Mt
CK80 A 080 R ...	80	80	102	112	150, 200, 250, 300	3,384
CK80 A 100 R ...		100		132		3,492
CK80 A 120 R ...		120		152		3,600
CK80 A 140 R ...		140		172		3,690
CK80 A 160 R ...		160		192		3,762
CK80 A 180 R ...		180		212		3,834
CK80 A 200 R ...	200	232	3,978			



CK80 AL SERİSİ İçten ve Dıştan Açılabilir Çita CK80 AL SERIE Openable From Inner and Outside

Örnek Ürün Kodu
Product No. Example

CK80

İç Yükseklik
Inner Height

AL

Alüminyum Çita
Aluminium Frame

400

İç Genişlik
Inner Width

R300

Kıvrılma Yarıçapı
Bending Radius

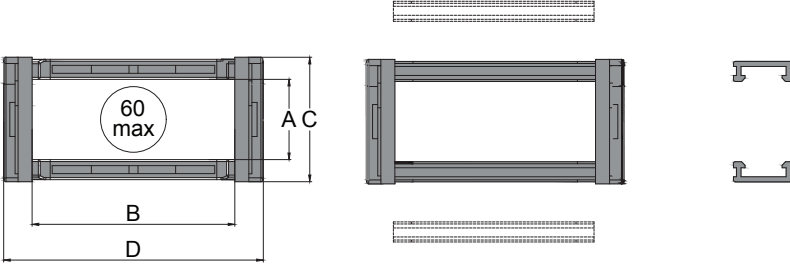

CK 80 AL	A	B	C	D	R	W
MODEL	İç Yükseklik (mm) Inner Height (mm)	İç Genişlik (mm) Inner Width (mm)	Dış Yükseklik (mm) Outer Height (mm)	Dış Genişlik (mm) Outer Width (mm)	Kıvrılma Yarıçapı Bending Radius	Ağırlık Kg/Mt Weight Kg/Mt
CK80 AL 250 R ...	80	250	102	282	150, 200, 250, 300	4,158
CK80 AL 300 R ...		300		332		4,374
CK80 AL 400 R ...		400		432		4,806
CK80 AL 500 R ...		500		532		5,238

Seçenek 1
Option 1



Seçenek 2
Option 2



Metal Ayak Montaj Ölçüleri

Metal End Bracket Assembly Dimensions

CK80 M

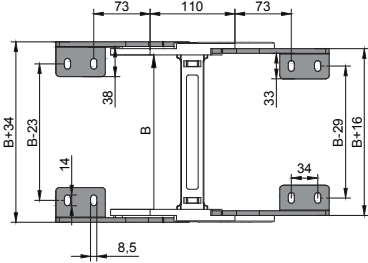

'B' ölçüsünü ölçü tablosundan bulabilirsiniz.
You will find the 'B' dimension from model table.

CK80 A

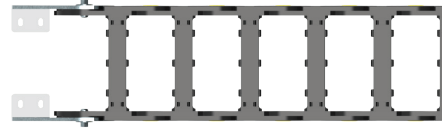

CK80 AL

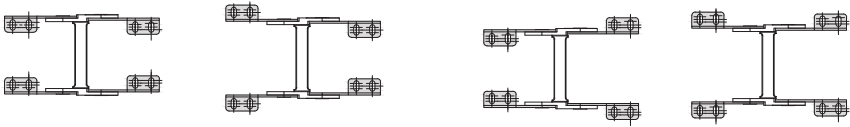
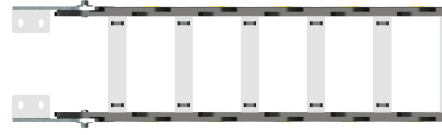

Metal Ayak Montaj

Metal End Bracket Assembly

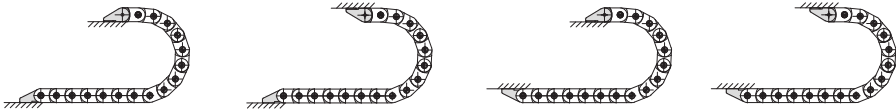

Dikey Separatör Ölçüleri

Vertical Separator Dimensions

CK80 SP

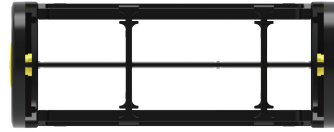
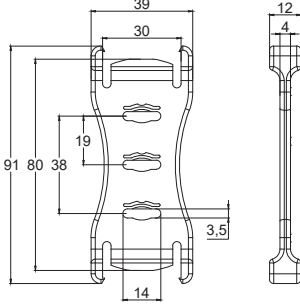

Yatay Separatör Ölçüleri

Horizontal Separator Dimensions

CK80 YSP

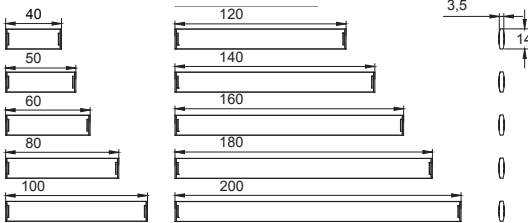

Orta Seri Plastik Kablo Sabitleyici
Medium Serie Plastic Strain Relief

CK SR

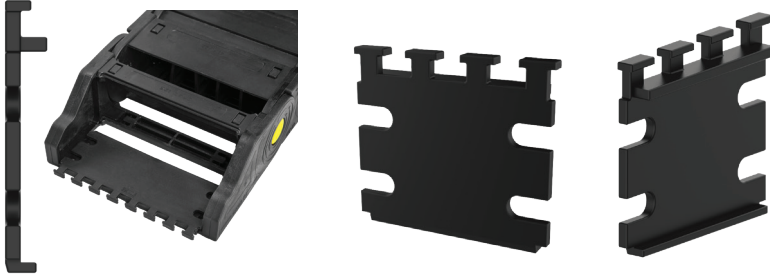

CK SR 040

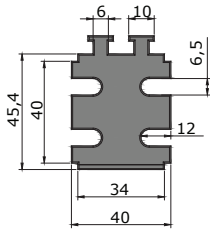

CK SR 050

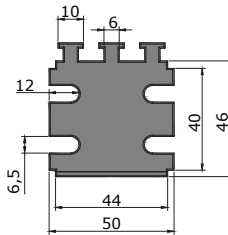

CK SR 060

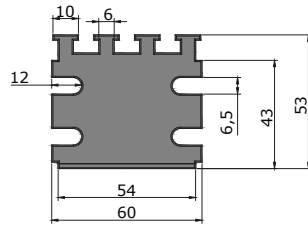

CK SR 070

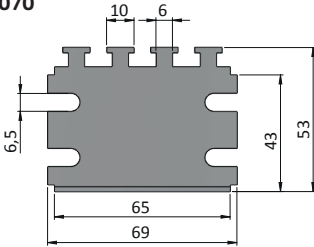

CK SR 080

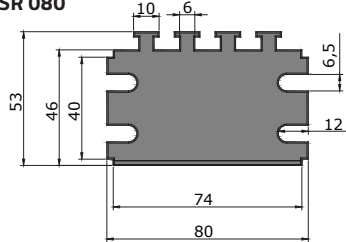

CK SR 100

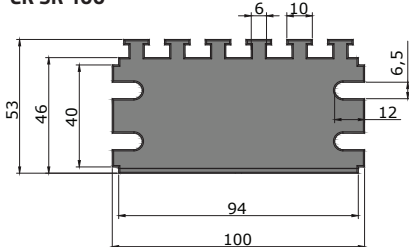

CK SR 125

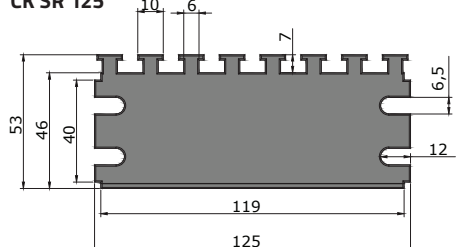

Kablo Sabitleyici
Strain Relief

CK KS

CK SR 1

