

BALLUFF

IO-Link
Portfolio

CONNECTING YOUR EQUIPMENT WITH SENSORS, RFID AND I/O

 *innovating automation*

 **IO-Link**

**I0-Link
Portfolio**

CONNECTING YOUR EQUIPMENT WITH SENSORS, RFID AND I/O

Innovative solutions

BALLUFF IO-LINK PORTFOLIO

 *innovating automation*

SENSORS



RFID



SAFETY



OBJECT DETECTION

- Photoelectric
- Capacitive
- Magnetic field
 - Multiple switch points
 - Adjustable hysteresis
 - C-slot and T-slot



MEASUREMENT

- Magnetostictive linear position sensors
 - In-cylinder rod-style
 - External-mount profile style
 - Measuring lengths up to 4.8 meters
- Magnetic linear encoders
 - Measuring lengths up to 8 meters
 - Flexible tape
 - Can be cut to length
- Short-stroke inductive sensors
 - Measuring lengths from 14...133 mm
 - Detects metal target



DISTANCE MEASUREMENT

- Photoelectric
 - Non-contact up to 6 M range
 - Resolution as low as 10 μ m
 - Laser light
- Inductive
 - Non-contact absolute measurement
 - Low temperature drift
 - Multiple form factors
- Ultrasonic
 - M18 straight and 90° housings
 - Automatic synchronization for multiple sensors



RFID SYSTEMS

- Multiple form factors
- 10 Byte or 32 Byte
- Simple configuration
- Global standard frequency
- IP69 washdown with ECOLAB: Food processing, beverage, meat, pharma and packaging
- High temperature
- Machine access control
- Work in process



SAFETY MODULES

- I/O hub with IN, OUT and OSSD
- I/O hub with isolated output power
- Communicate to most safety devices using PROFIsafe over IO-Link technology



INDUSTRIAL NETWORKING

HUMAN MACHINE INTERFACES

IO-LINK MASTER BLOCKS

EtherNet/IP



EtherCAT

CC-Link IE

DeviceNet



CC-Link

- IO-Link masters for most major fieldbuses and networks
- Application specific families
 - Weld block: Welding or high noise environment
 - IP69 washdown with ECOLAB: Food processing, beverage, meat, pharma and packaging
 - Factory automation IP67
- Capable of up to 240 I/O counts with 8 channel master
- High amperage output support for valve banks or cylinder



IO-LINK HUBS

- Ability to consolidate up to 16 sensors/actuators
- Multiple options
 - M8
 - M12
 - Input only
 - Output only
 - Configurable I/O
 - With expansion port
- Application areas
 - Weld block
 - IP69 washdown
 - IP67 factory automation
 - IP20 inside cabinet



VALVE CONNECTORS

- Enables existing valve banks to use IO-Link
- D-sub connectors – FESTO, SMC, MAC Numatics, Parker, and more



UNIVERSAL I/O INTERFACE

- 8 or 16 freely configurable I/O
- Up to 1. A max total current
- Open coil and short circuit detection diagnostics



TEMPERATURE ANALOG I/O

- Single or multi-channel analog I/O to IO-Link communication
- Every channel is configurable for current/voltage measurement
- Up to 16 bit resolution and ability to add set points per channel



SIGNAL CONVERTER

- RS232 to IO-Link
- Enables bringing scanner printers and other serial devices to IO-Link
- Inline barrel style design with IP67



INDUCTIVE COUPLERS

- Non-contact power and data exchange over IO-Link
- Q40 housing with max. 1A power
- M30 housing with max. 1A power
- IO-Link input only
- IO-Link 3-directional connection
- IP67 protection rating



VISUALIZATION DEVICES

- SmartLight tower lights
- SmartLight indicators
- Visualize various states of a process
- Report progress or errors prominently with/without buzzer option



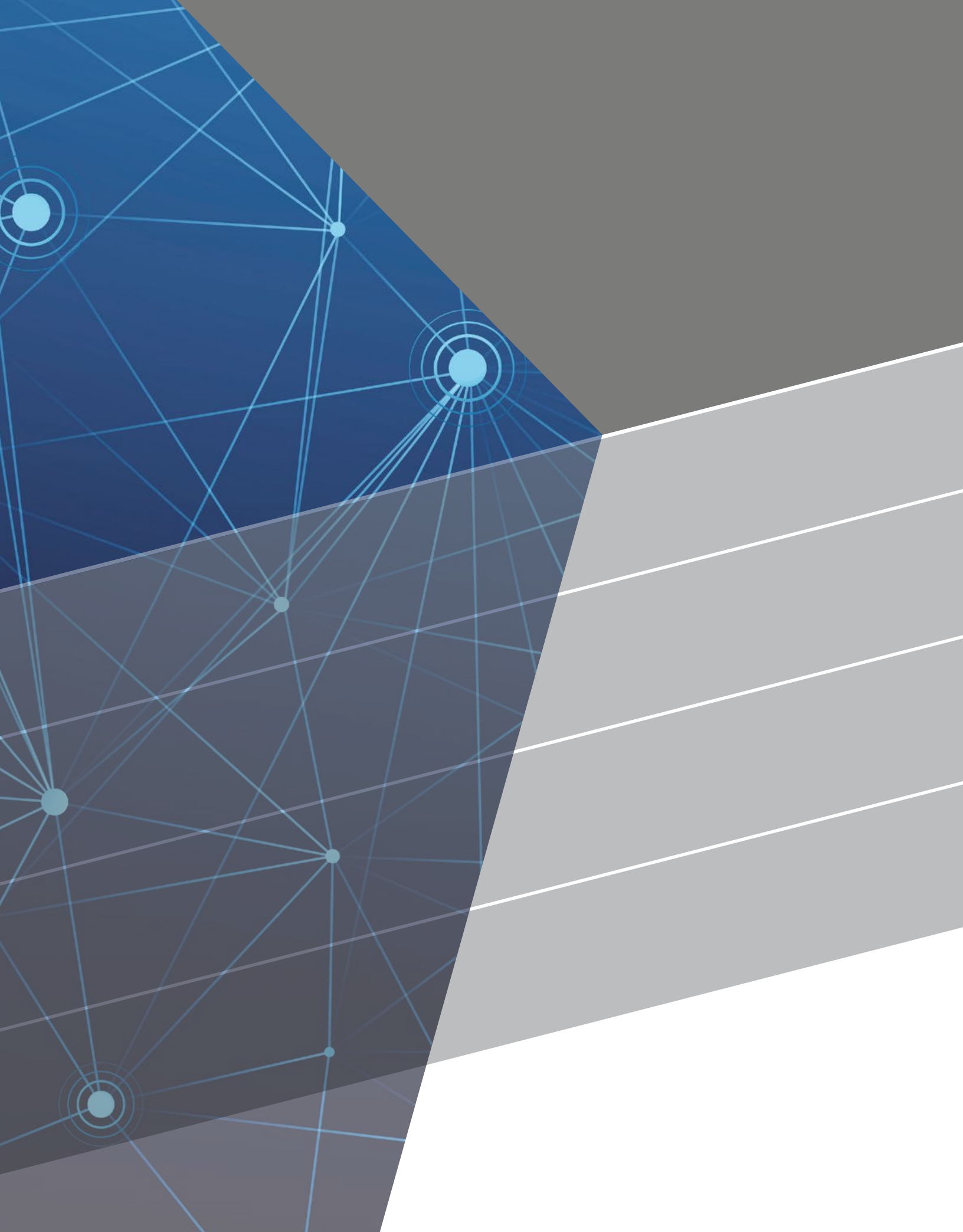

CONTENTS

10

IO-LINK – THE IDEAL SOLUTION



Fast, flexible and efficient production

12

IO-LINK – THE NEXT EVOLUTION

 IO-Link

Modular control concepts

14

IO-LINK ARCHITECTURES

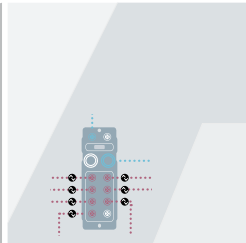

- 14 IO-Link saves time and money
- 16 Migrate fieldbuses
- 17 Automate robots
- 18 Consolidate and gather I/O signals
- 20 Track data
- 21 Measure, control and regulate
- 22 Signaling
- 23 Handling and assembly

24

IO-LINK APPLICATIONS

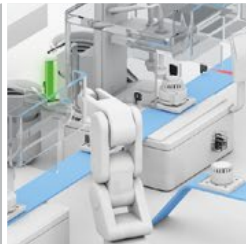

- 24 We Speak IO-Link
- 26 Communicate consistently interference-free
- 28 Quick tool changing
- 30 Position workpieces in assembly
- 32 Monitor process media
- 34 Easily visualize operating states
- 36 Constant temperatures for induction hardening
- 38 Monitoring clamping in the machine system
- 40 Automatically acquire data
- 42 Automate format changes
- 44 Measure position and end-of-travel with absolute accuracy
- 46 Quality control to your individual specifications
- 48 Automated tool management
- 50 Safety over IO-Link
- 52 Safe personal protection
- 54 Safety for people and systems
- 56 Safety for clamping equipment
- 58 Reliably transmit signals in electrical noise fields
- 60 The optimal power supply for condition monitoring

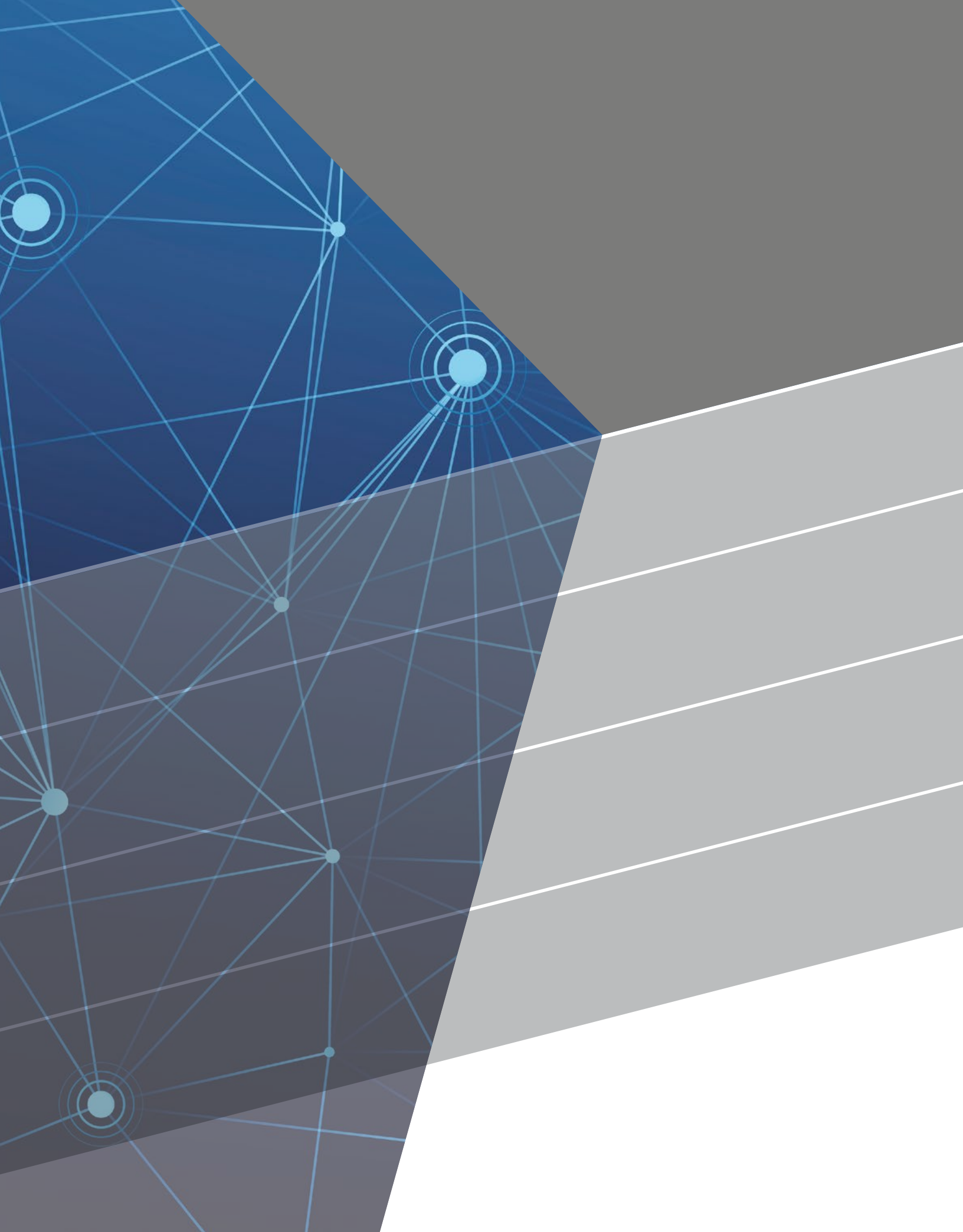

CONTENTS

62

SENSORS

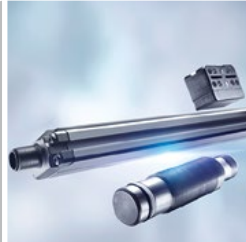

- 64 Inductive sensors
- 70 Photoelectric sensors
- 82 Capacitive sensors
- 86 Magnetic field sensors
- 88 Ultrasonic sensors

- 90 Mechanical switches
- 92 Magnetostrictive sensors
- 94 Magnetic encoders
- 96 Pressure sensors
- 106 Temperature sensor

108

RFID



- 110 RFID system HF (13.56 MHz) BIS M read/write heads
- 116 RFID system LF (125 kHz) BIS L read only heads
- 118 RFID system LF (125 kHz) BIS V IO-Link master

122

MACHINE VISION



- 124 SmartCamera IO-Link master

126

SAFETY



- 128 Safety I/O modules

WARNING

- Read, understand, and follow warnings and manual. Failure to do so could result in serious injury or death.
- NEVER USE AS A SENSING DEVICE FOR PERSONNEL PROTECTION
- Does NOT include self-checking redundancy circuitry required for use in personnel safety applications
- Does NOT meet OSHA and ANSI standards for point-of-operation devices

Balluff, Inc. · www.balluff.com · 1-800-543-8390

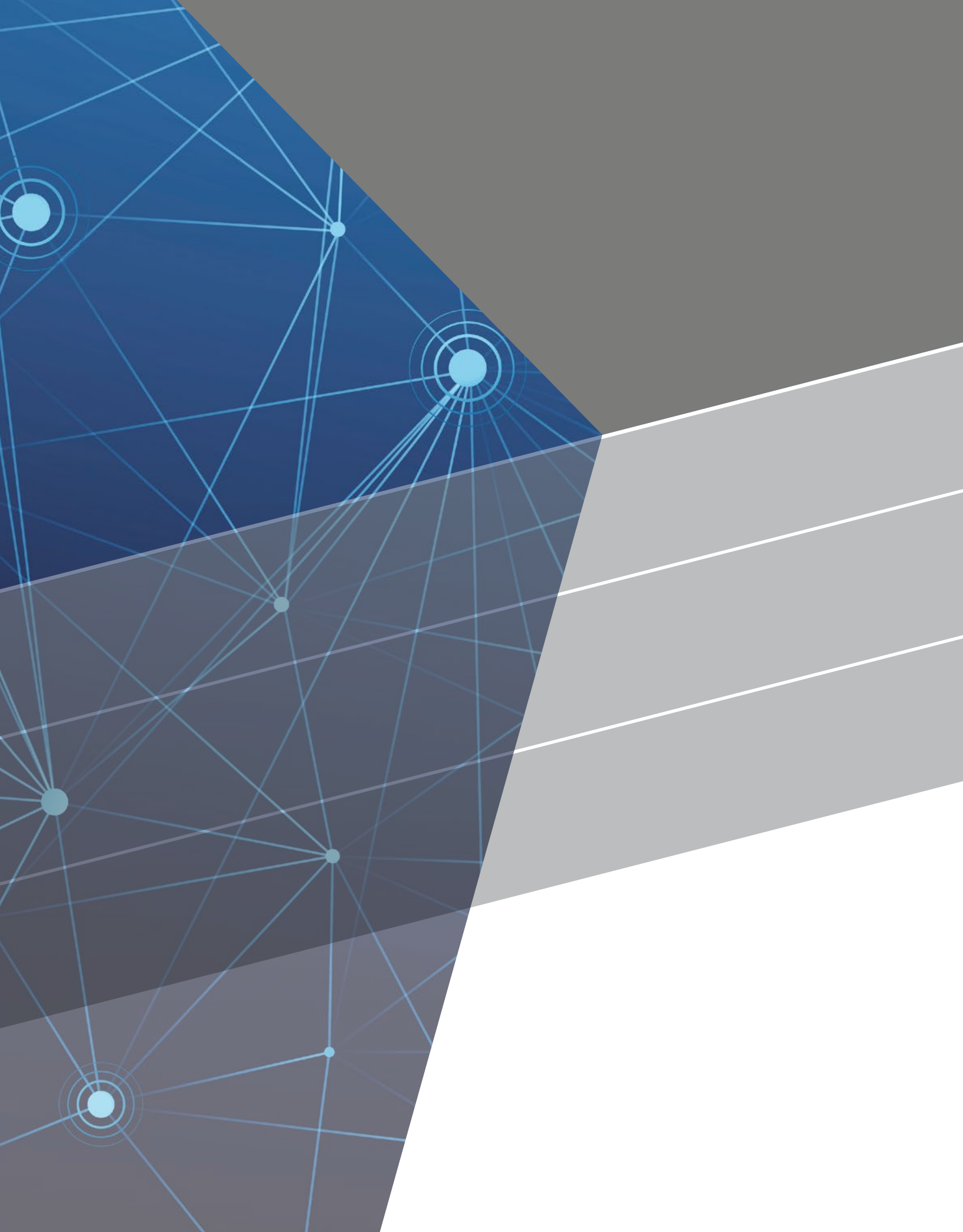

CONTENTS

132

INDUSTRIAL NETWORKING



188

HUMAN MACHINE INTERFACES

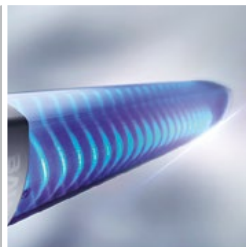

196

POWER SUPPLIES



134 IO-Link master blocks
 150 Discrete I/O hubs
 168 Valve interfaces
 174 Universal discrete I/O
 176 Analog I/O
 182 Signal converters
 183 Memory module
 184 Inductive couplers

190 SmartLight tower lights
 194 SmartLight indicators

198 IP67 machine mount power supplies
 200 IP20 DIN rail power supplies
 201 Communication adapter and signal converter

SERVICES 202

REFERENCES 204

INDEX 206

WARNING

- Read, understand, and follow warnings and manual. Failure to do so could result in serious injury or death.
- NEVER USE AS A SENSING DEVICE FOR PERSONNEL PROTECTION
- Does NOT include self-checking redundancy circuitry required for use in personnel safety applications
- Does NOT meet OSHA and ANSI standards for point-of-operation devices

Balluff, Inc. · www.balluff.com · 1-800-543-8390

Fast, flexible and efficient production

IO-LINK – THE IDEAL SOLUTION



Just one interface for improved process quality

Intelligent combining of industrial network with the IO-Link communication standard is the ideal solution for faster, more flexible, more efficient and more adaptable production. This provides you with a powerful infrastructure for reliably managing the growing volume of data. It transports your data through the entire manufacturing process and enables seamless communication from the sensor into the internet, making IO-Link the ideal enabler for Industry 4.0.

How IO-Link increases the performance of your network

IO-Link is the first globally standardized IO technology (IEC 61131-9) that communicates from the controller down to the lowest automation level. This universally applicable interface is a fieldbus-neutral, point-to-point connection, which uses standard unshielded cables. IO-Link sends all the sensor and actuator signals to the controller and then carries controller data to the sensor/actuator level with revolutionary consequences.

This open standard opens all sensors to the fieldbus level and even transports analog signals noise-free by digitizing them. IO-Link enables fully continuous diagnostics as well as automated configuration of the IO-Link devices via the controller. This means IO-Link is simple to install. In addition to the IO-Link master, all you need is a standard unshielded 3- or 4-conductor cable to connect sensors and actuators.



Modular control concepts

IO-LINK – THE NEXT EVOLUTION

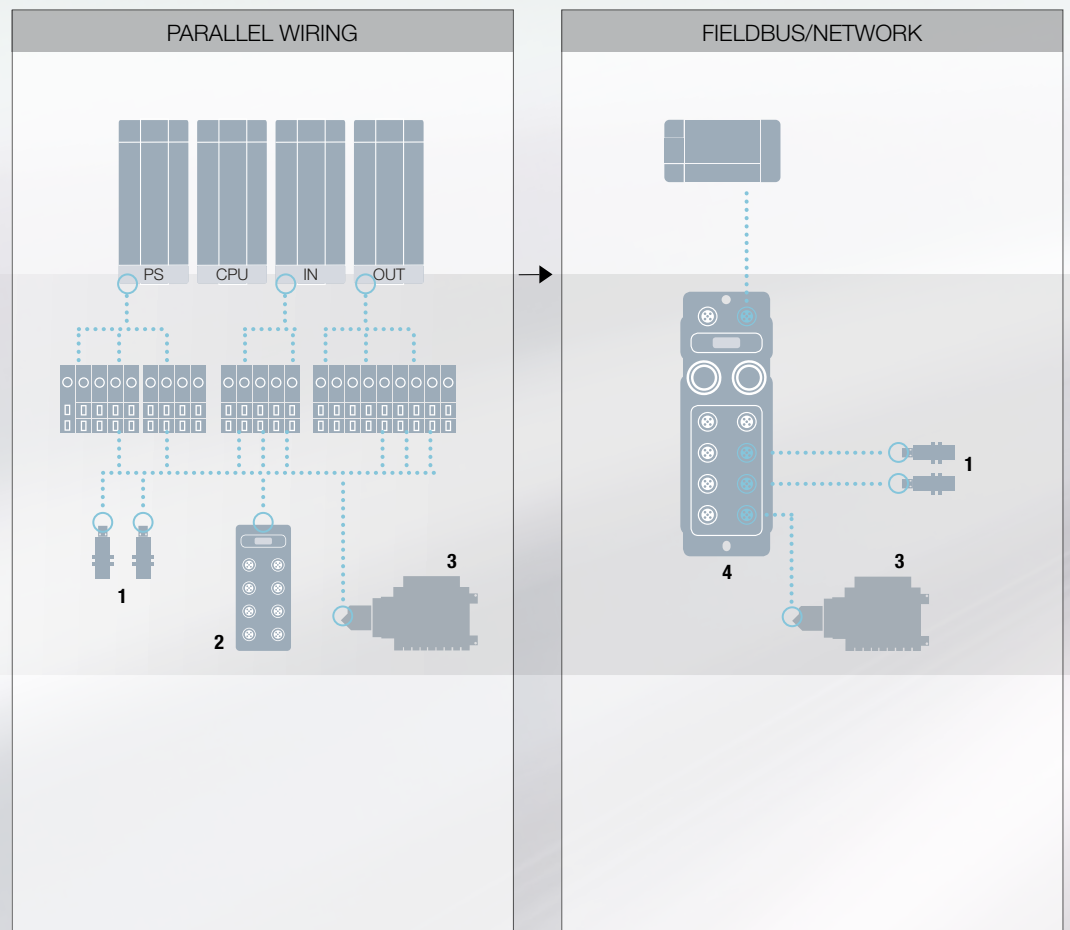

- 1 Terminal block
- 2 Sensors
- 3 Junction blocks
- 4 Valve interfaces
- 5 Fieldbus module
- 6 IO-Link SmartLight
- 7 IO-Link pressure sensor
- 8 Industrial RFID system
- 9 IO-Link master
- 10 IO-Link analog converter
- 11 IO-Link valve interfaces
- 12 IO-Link sensor hubs
- 13 IO-Link safety hubs
- 14 Opto-electronic protective devices
- 15 Emergency stop device

From parallel wiring to the fieldbus protocol

Replacing parallel wiring with fieldbuses was an enormous step because fieldbus protocol has successfully eliminated the immense installation effort associated with copper cables and substantially reduced costs. It is not just that the use of fieldbuses reduces working time because a bus cable replaces numerous parallel strands of wire, since fewer strands are needed, material and space are also conserved. Simultaneously, the bus cable connects the components of different levels, creating a system without the need for a control cabinet.

Pitfalls of the fieldbus protocol

Fieldbus cables are not without problems however, even if their protocol is no longer electrical, and the cabling effort goes down by orders of magnitude. Fieldbus cables have a low signal level, are noise-susceptible, inflexible and are expensive because of the shield.

Universal, simple and flexible: IO-Link!

The weaknesses of the fieldbus protocol are now a thing of the past thanks to IO-Link. The standard unshielded, 3- or 4-conductor industrial cables are highly flexible and suitable for many bending cycles, easy to connect, highly economical, and can use M5, M8 or M12 connectors. Therefore, with IO-Link you can rely on an established standard for connecting the widest possible variety of devices. IO-Link ensures extremely flexible control concepts. This versatility, simplicity and performance capability mean IO-Link can be considered a universal interface – like USB – in automation.

But with IO-Link the flexibility is even greater thanks to the inclusion of a safety solution. With Safety over IO-Link, Balluff offers the first safety solution to be integrated with IO-Link for combining safety and automation technology in one system. Safety over IO-Link provides both sensor/actuator details as well as safety information, so that you can benefit from the best of both worlds.

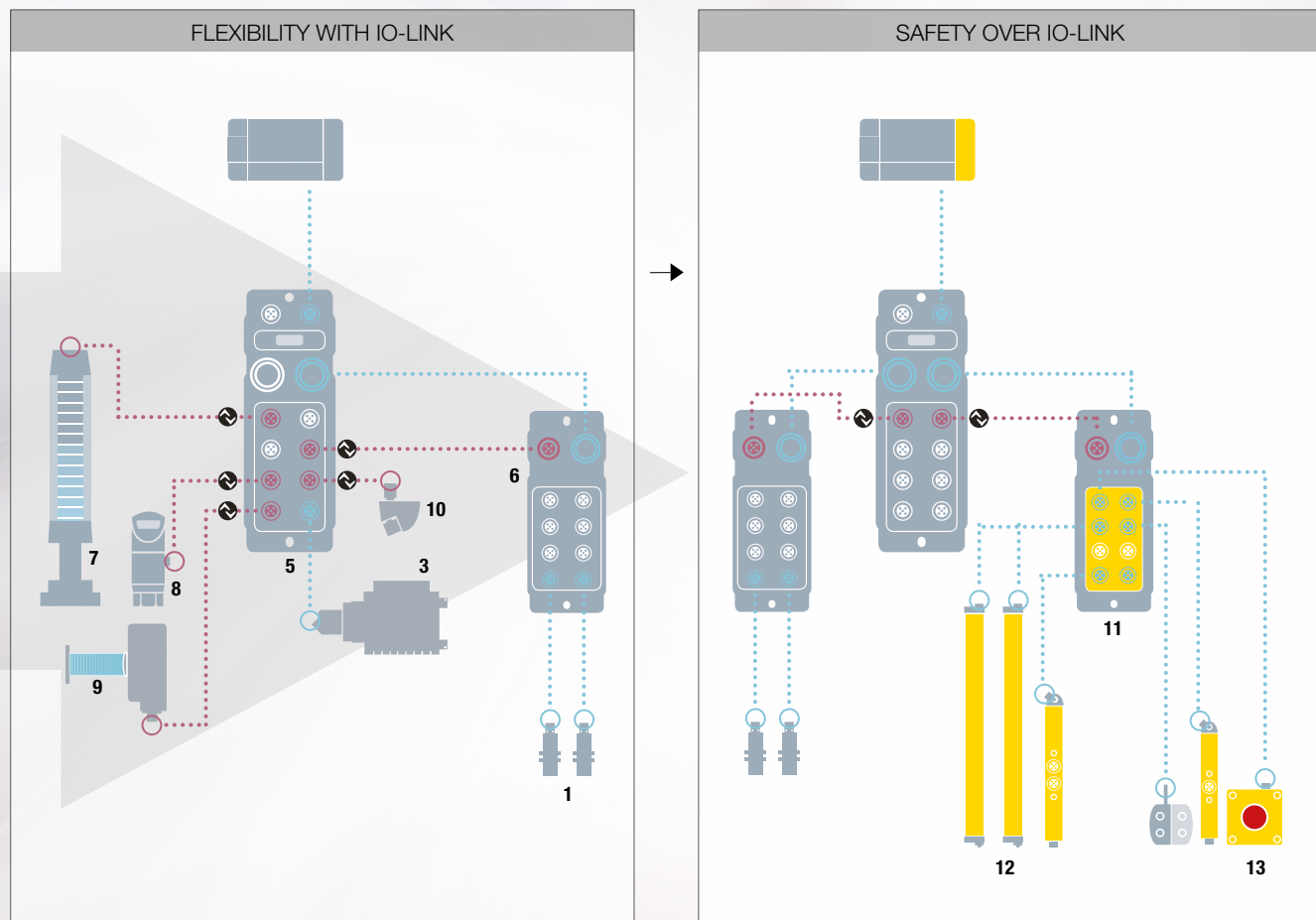

IO-Link Architectures

IO-LINK SAVES TIME AND MONEY.



innovating automation

Easy installation

With IO-Link all you need is an industry-standard 3- or 4-conductor cable. The industry standard interface can be quickly and easily integrated into the fieldbus world to simply link even complex devices. One special feature: the digital communication ensures noise immunity even without the use of expensive shielded cabling. Analog signals are digitized with no conversion losses.

Highest machine availability

IO-Link enables quick, error-free sensor replacement and prompt commissioning. You can significantly reduce downtime since the parameters of a replaced IO-Link sensor are automatically written from the IO-Link master to the new sensor. Commissioning processes, format changes or recipe changes are handled centrally via the controller's function modules. This saves time and greatly reduces the potential for mistakes. Another advantage to you: IO-Link devices cannot be mixed up since they are automatically identifiable via IO-Link.

Requirements-based maintenance

Continuous diagnostic data for the entire process extends your service intervals. Automatic readjustment via IO-Link means you need to maintain equipment and machines much less often. And now predictive error detection is possible because the complete process parameters are consistently displayed in the controller.

More efficient operation

With IO-Link, accessibility of the sensors is no longer a factor; you can position sensors in the machine as the process requires. Process monitoring, configuration and error analysis of the IO-Link devices now takes place in the controller and machine sequences are time-optimized. Signal delays and distortions are reliably eliminated because digital transmission of data ensures high signal quality.

A wide range of application requirements can be easily met with IO-Link because you can use both binary and analog standard devices at the same time along with IO-Link sensors/actuators.

High-performance, consistent network

Controller concepts using IO-Link provide you with simple and universal solutions for a high-performance, consistent network, lower costs and more flexibility than ever.

Review the typical applications presented on the next pages to learn about the possibilities IO-Link opens up for you.

STANDARD
SENSORS/
ACTUATORS

STANDARD PLC

SAFETY PLC



DeviceNet
EtherNet/IP
EtherCAT

CC-Link
CC-Link IE
Field

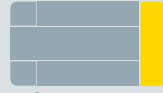

FIELD BUS MASTER WITH IO-LINK INTERFACE



IO-LINK DEVICES

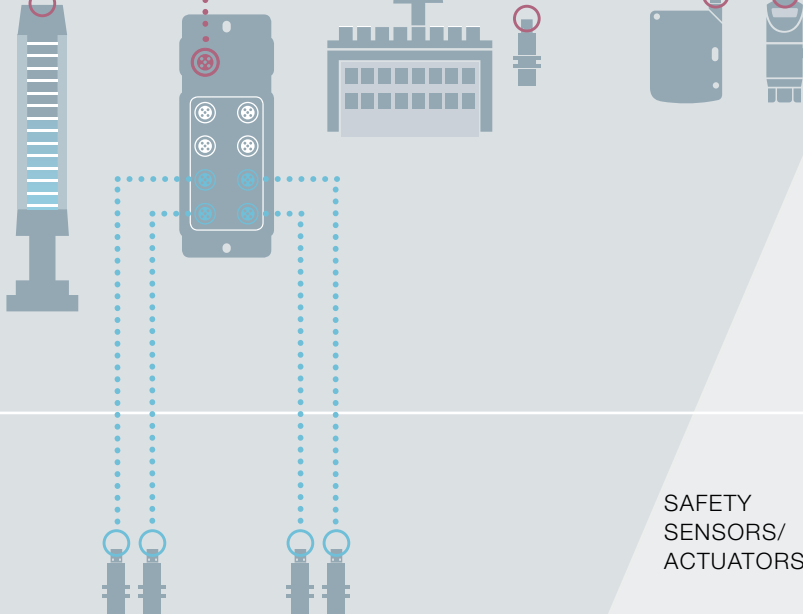

SAFETY-OVER-IO-LINK DEVICE*

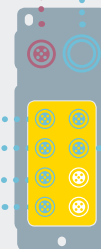

SAFETY SENSORS/ACTUATORS

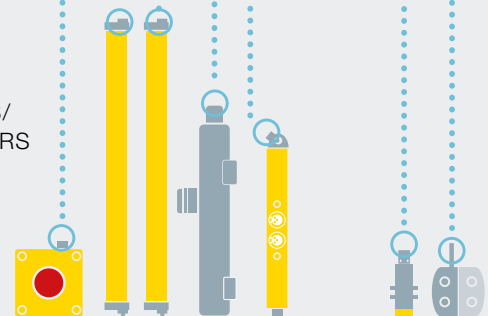

*for use only with Profinet

IO-Link provides a high standardization factor

Migrate fieldbuses

Plug and play in all networks

As a systems and machine builder, you market and sell your products around the globe. This means your products have to adapt to the conditions of very different countries and be tuned to very different networks.

No matter what countries you are active in, IO-Link provides one concept for field installation for various markets: Profibus, Profinet, Devicenet, Ethernet/IP, EtherCAT, CC-Link or CC-Link IE/Field.

To adapt the bus system, simply change out the master and continue working seamlessly with virtually identical schematics – without any added effort.

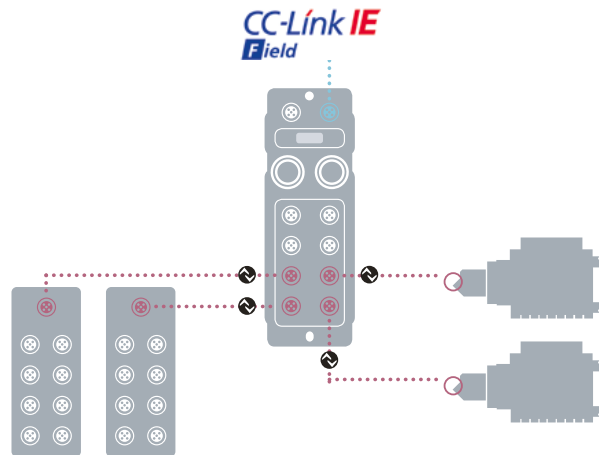
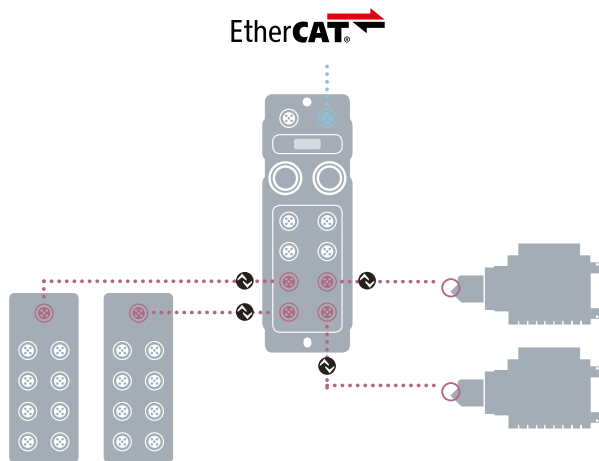
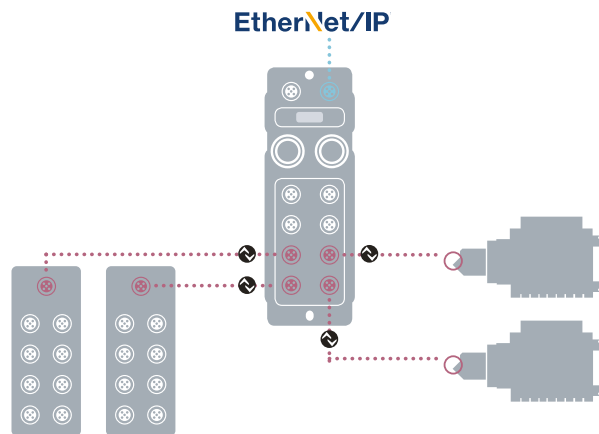
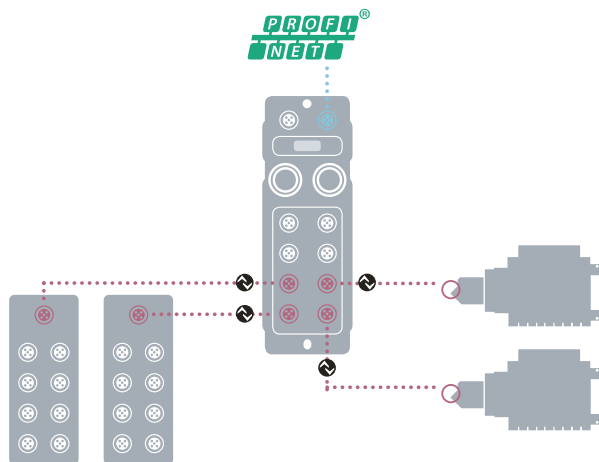

A simple M12 connection is all you need

Automate robots

Profit from minimal downtime

Modern robot systems require numerous sensors – particularly robot arms, which only tolerate lightweight sensors in order to maintain proper dynamics. Traditional wiring of multiple cables can make it difficult to achieve high efficiency and increases project costs.

Thanks to IO-Link, difficulties like this are a thing of the past. A standard M12 connection is all you need to ensure the function of the robot – no need for special connectors. An I/O module and valve terminal are easily linked and complexity is reduced.

Inductive couplers provide you with quick tool changes because they send both data and power at the same time over an air gap. The plug-and-play style allows for prompt connection of the new tool and is automatically parameterized by the controller via IO-Link. You no longer struggle with cable breaks, but rather profit from high flexibility and minimal downtime.

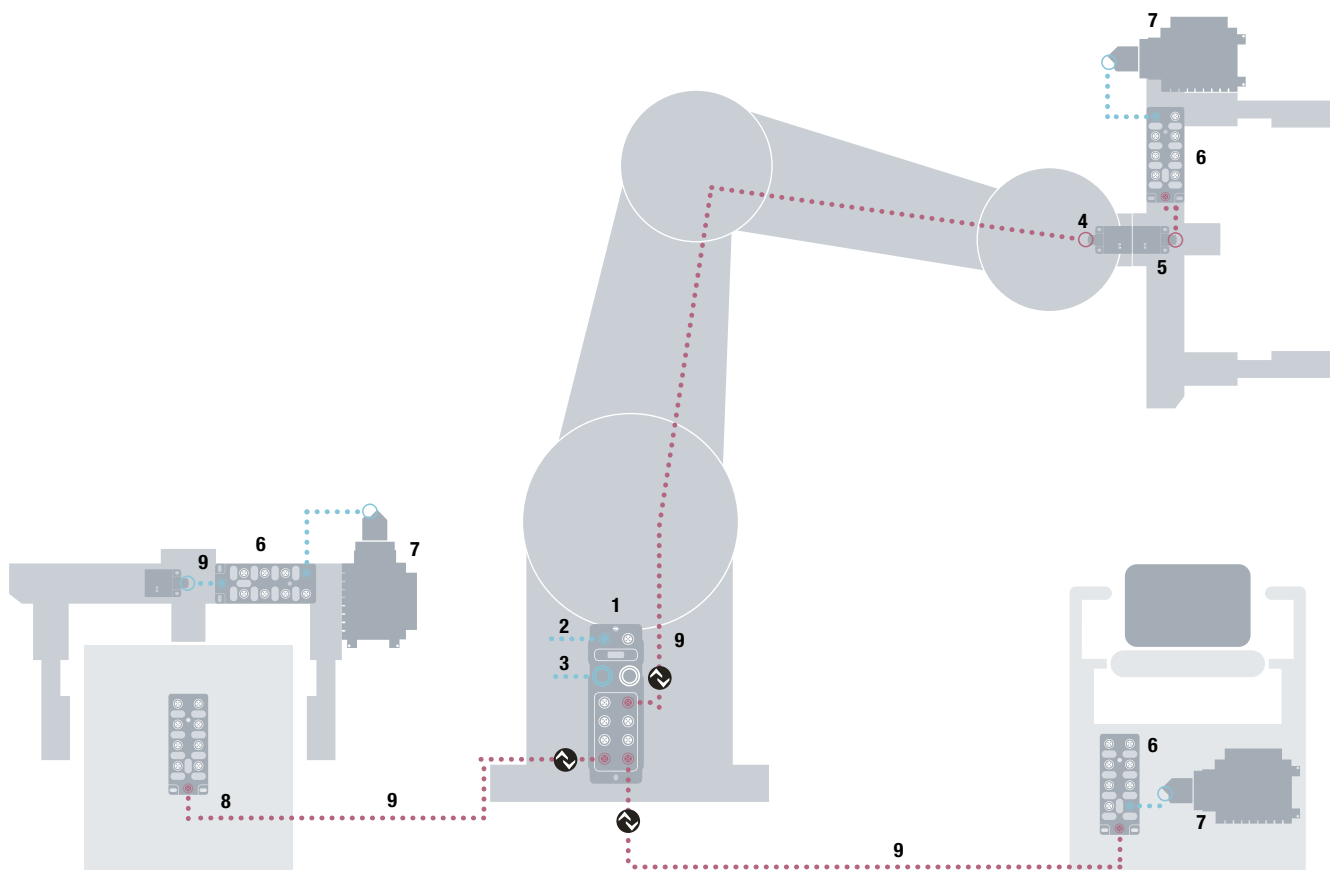

- | | |
|---|--|
| 1 IO-Link master | 6 M12 sensor hub, configurable, I/O with expansion |
| 2 Fieldbus cable | 7 IO-Link valve interface (Festo, Bosch Rexroth) |
| 3 Power cable, 7/8" | 8 M12 sensor hub, 16 inputs, PNP |
| 4 Inductive coupler, 40 × 40 mm, Base, IO-Link, bi-directional | 9 Single-ended cordset, M12 → M12, 4-conductor |
| 5 Inductive coupler 40 × 40 mm, Remote, IO-Link, bi-directional | |

Expand decentralization

Consolidate and gather I/O signals

Minimize critical installations

With IO-Link, you need only a node/IP address to transmit the data of up to 496 inputs/outputs. Compression of the data allows you to preserve the valuable addresses and minimize critical installations.

The IO-Link actuator/sensor hub with its expansion port sets the standard. Combined with the IO-Link master, it equips you with completely new options for expanding the decentralized structure of your network topology by using the port to connect valve interfaces or an additional IO-Link hub. Simply, it is plug and play. Additional inputs and outputs are processed this easily as well with no additional master.

Configure up to 496 I/O's

A 16x IO-Link master allows up to 496 I/Os to be configured. The range is doubled and exponential cost savings are realized.

All you need to implement this network structure is a standard, unshielded cable. You maintain access to the entire IO-Link functionality while reducing your wiring effort and saving money.

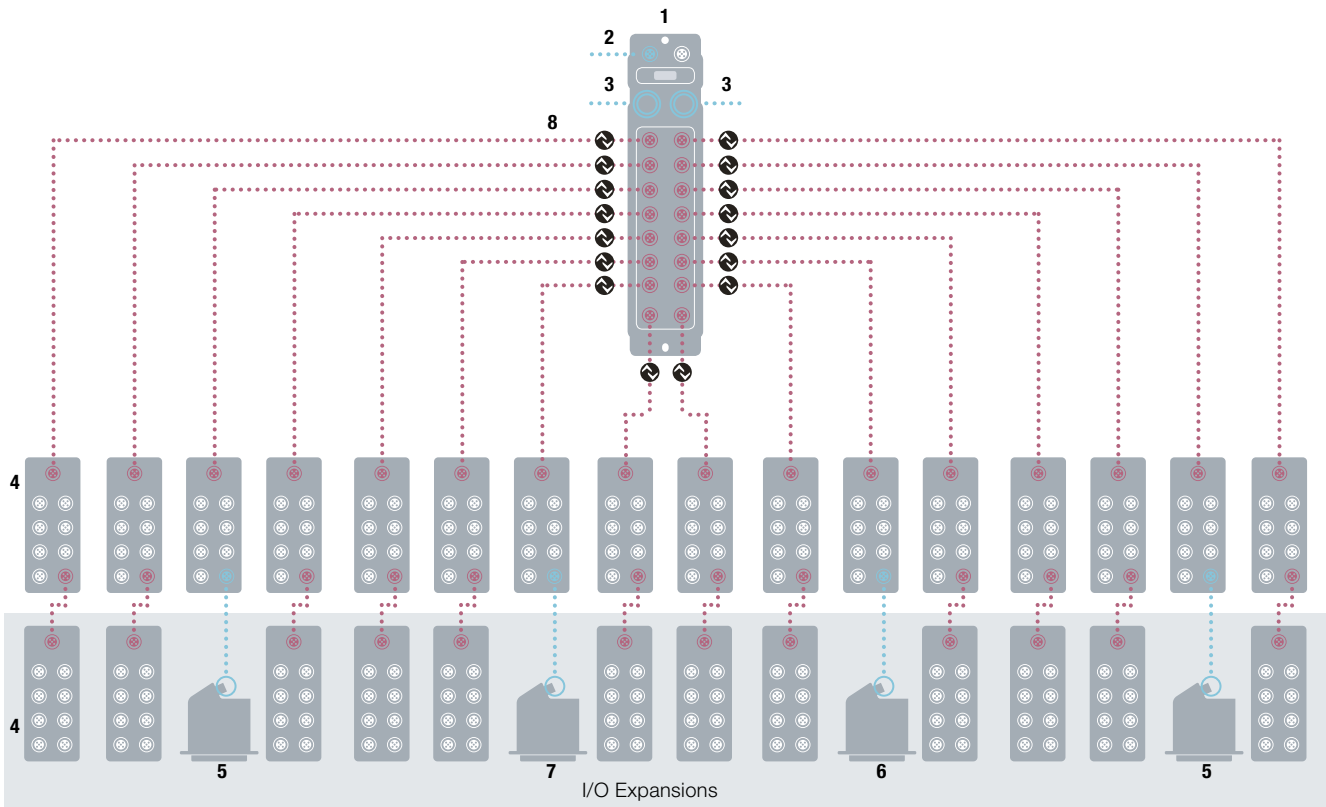

- 1 IO-Link master
- 2 Fieldbus cable
- 3 Power cable, 7/8"
- 4 IO-Link sensor hub, configurable, I/O with expansion
- 5 IO-Link valve interface (Festo, Bosch Rexroth)
- 6 IO-Link valve interface (SMC, Parker, Norgren)
- 7 IO-Link valve interface (Numatics)
- 8 Single-ended cordset, M12 → M12, 4-conductor

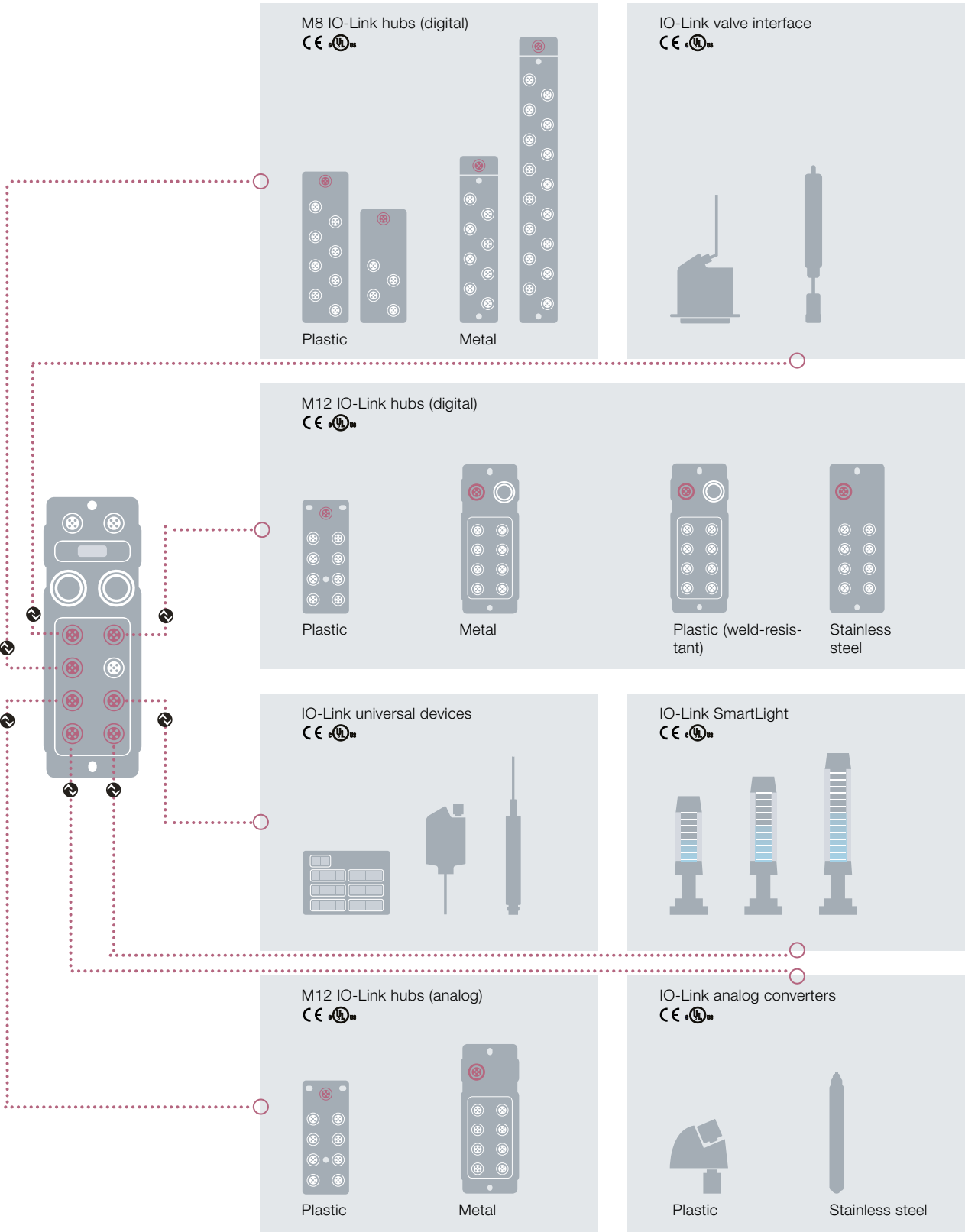

Maximum transparency for the optimal process

Track data

Ensure quality

The intelligent combination of RFID and sensors with IO-Link makes it possible to cost-effectively handle your identification requirements and process signals at the same time.

When it comes to quality assurance, RFID systems record the entire production sequence and make it traceable in real time. The data is documented directly on the workpiece or pallet, regardless of ambient conditions, read distances or technologies (low-frequency – LF, high-frequency – HF, ultra-high frequency – UHF).

Depending on your data volume and speed, we offer different devices including BIS V processor units for fast processing of high data volumes. And if you need to run LF, HF and UHF read/write heads simultaneously, the BIS V lets you process all these RFID technologies at the same time.

An IO-Link master is appropriate for standard ID tasks to connect I/O units or IO-Link-capable sensors/actuators. Each individual production step, for example, can be displayed using the SmartLight tower light.

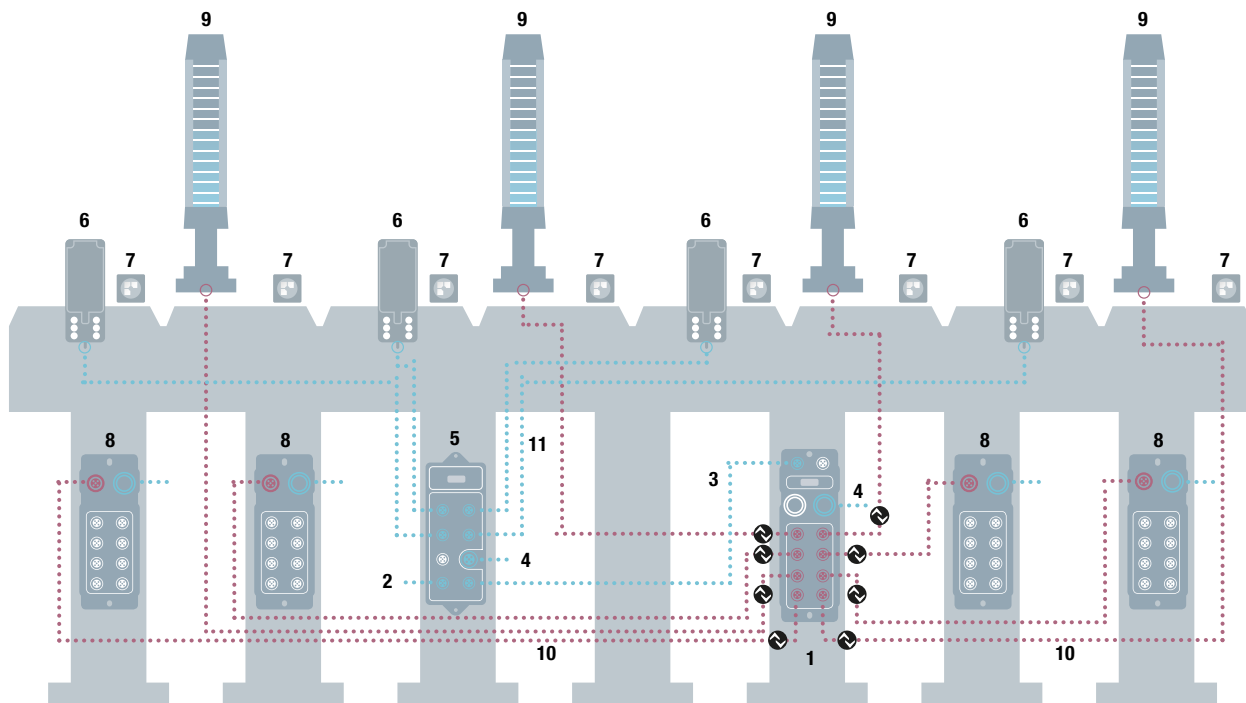

- 1 Profinet, 8 × IO-Link master
- 2 Profinet cable, M12 → RJ45, shielded
- 3 Profinet cable, M12 → M12, shielded
- 4 Power cable, 7/8", 4-conductor
- 5 Industrial RFID, Profinet processor unit 4x, 1 × IO-Link master
- 6 Industrial RFID, read/write head
- 7 Industrial RFID, data carrier
- 8 M12 sensor hub (metal), 16 I/O, configurable
- 9 IO-Link SmartLight, 3 segments
- 10 Single-ended cordset, M12 → M12, 4-conductor
- 11 RFID single-ended cordset, M12 → M14, shielded, 4-conductor

Correctly feed process media

Measure, control and regulate

Example with oil supply for a hydraulic cylinder

IO-Link and simple, unshielded, standard cables ensure correct feeding of your process media. An IO-Link master is all you need to receive and pass along the data. You can use a single bus address for the entire control circuit of the master assembly.

For example, you can automatically measure, control and regulate all the relevant components for the oil feed of a hydraulic cylinder – pressure, temperature and flow sensors, control valve and the hydraulic cylinder itself – which ensures the optimum oil flow.

The sensors measure the flow, temperature and pressure of the oil. This data is continuously passed to the variable regulator through the master, with the regulator comparing the data with the nominal value and initiating, if necessary, a readjustment and providing feedback to the controller.

Correct control of the hydraulic cylinder by the control valve is now possible. The master also passes this information to the controller, which in turn generates the positioning commands for the hydraulic cylinder. These commands then arrive where they are needed through the master.

Another great feature: you can wire the entire control circuit with unshielded, 3- or 4-conductor cables.

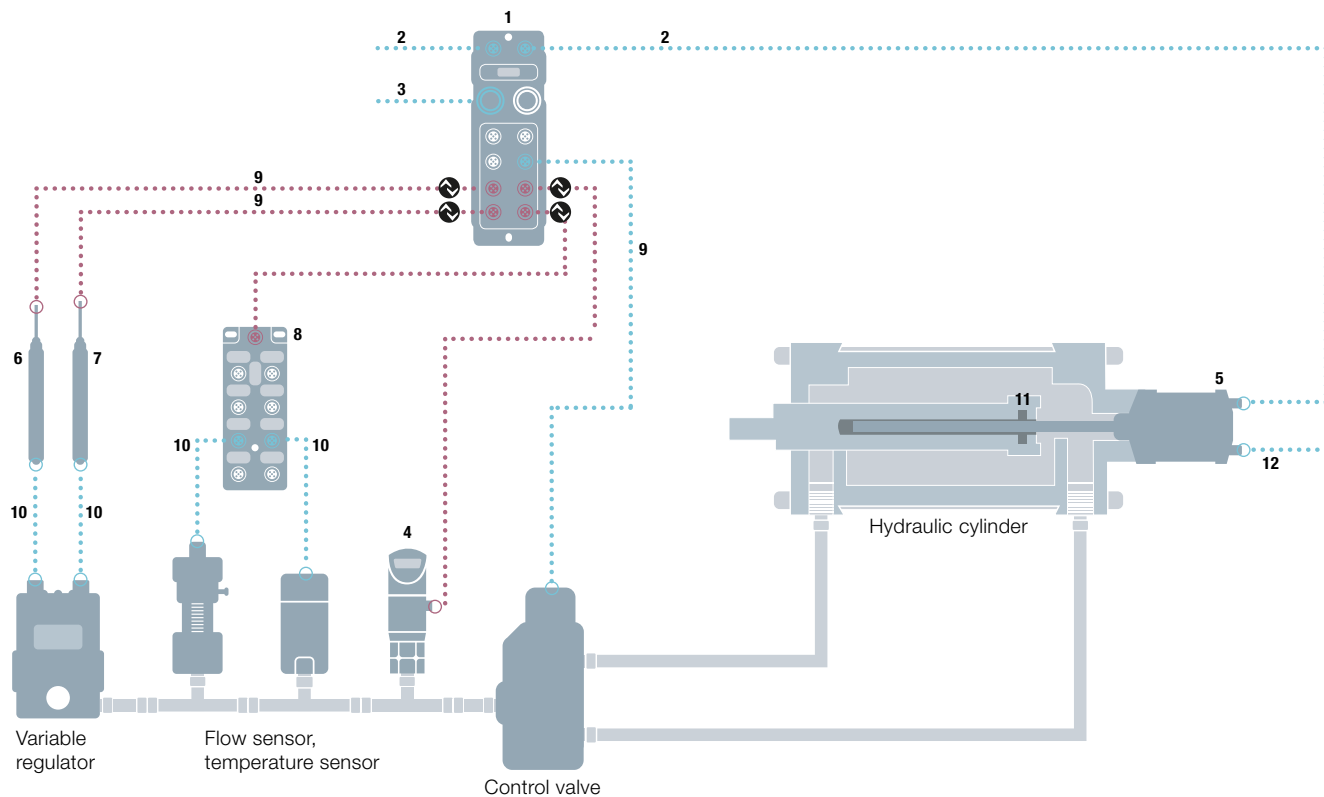

- 1 Profinet, 4 × IO-Link master
- 2 Profinet cable, M12 → M12, shielded
- 3 Power cable, 7/8", 4-conductor
- 4 IO-Link pressure sensor
- 5 Profinet transducer BTL7, length max. 7620 mm
- 6 IO-Link- analog converter, input 0...10 V DC

- 7 IO-Link analog converter, output 0...10 V DC
- 8 M12 sensor hub, analog 0...10 V DC, digital
- 9 Single-ended cordset, M12 → M12, 4-conductor
- 10 Single-ended cordset, M12 → M12, shielded, 4-conductor
- 11 Magnet for transducer
- 12 Power cable, M12, 4-conductor

Continuous diagnostics of the operating states

Signaling

Setup without mechanical reconfiguring

If you need seamless visualization of the production sequence on your production line, the SmartLight signal tower light provides the perfect solution. The SmartLight displays trends and tendencies, so that you can continually monitor various stages. This optimizes cycle times and gives early indication of any possible bottlenecks or maintenance duties.

The various modes – run light, stack light and level mode – can be set without making any mechanical changes. Use the controller to choose between running light, color gradient or the display of up to five color segments.

Just as important: the SmartLight is simple to retrofit.

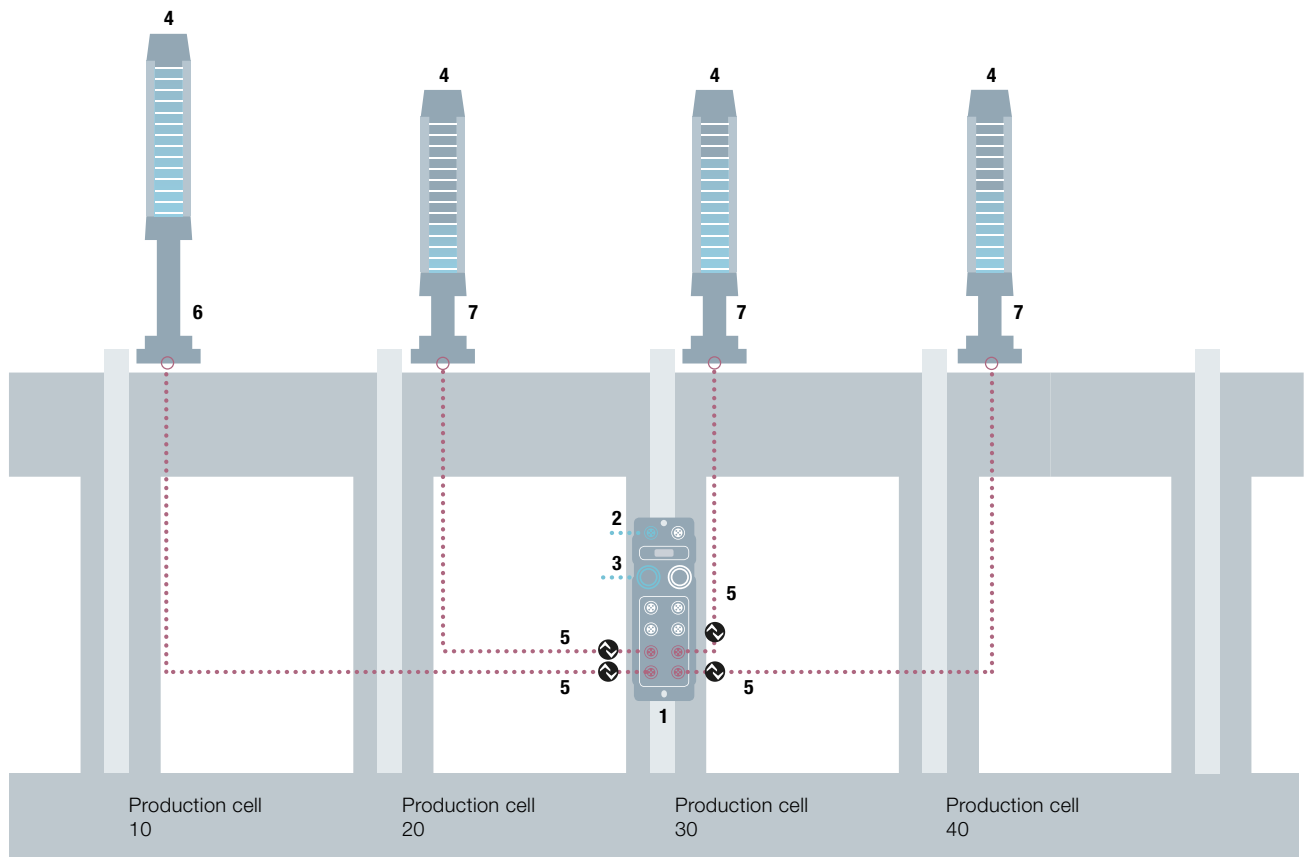

- 1 IO-Link Master
- 2 Fieldbus cable
- 3 Power cable, 7/8"
- 4 IO-Link SmartLight, 5 segments and buzzer
- 5 Single-ended cordset, M12 → M12, 4-conductor
- 6 Stand for SmartLight, 400 mm high
- 7 Stand for SmartLight, 100 mm high

A network distributor for complex tasks

Handling and assembly

Reduce the number of needed modules

Whether you are bundling signals, switching pneumatics, recording and tracking data, or want to display operating conditions with the SmartLight tower light, one network distributor used as a remote data compressor can handle all of your complex tasks.

One IO-Link master per production segment is all you need; it handles all the analog functions, RFID applications, the valve control, signaling and the use of remote I/O. This allows you to reduce various modules and select and deselect equipment options. This affords you great flexibility and saves you cash. At the same time, an IO-Link master is extremely powerful and user-friendly with additional features like a display, integrated switch and web server.

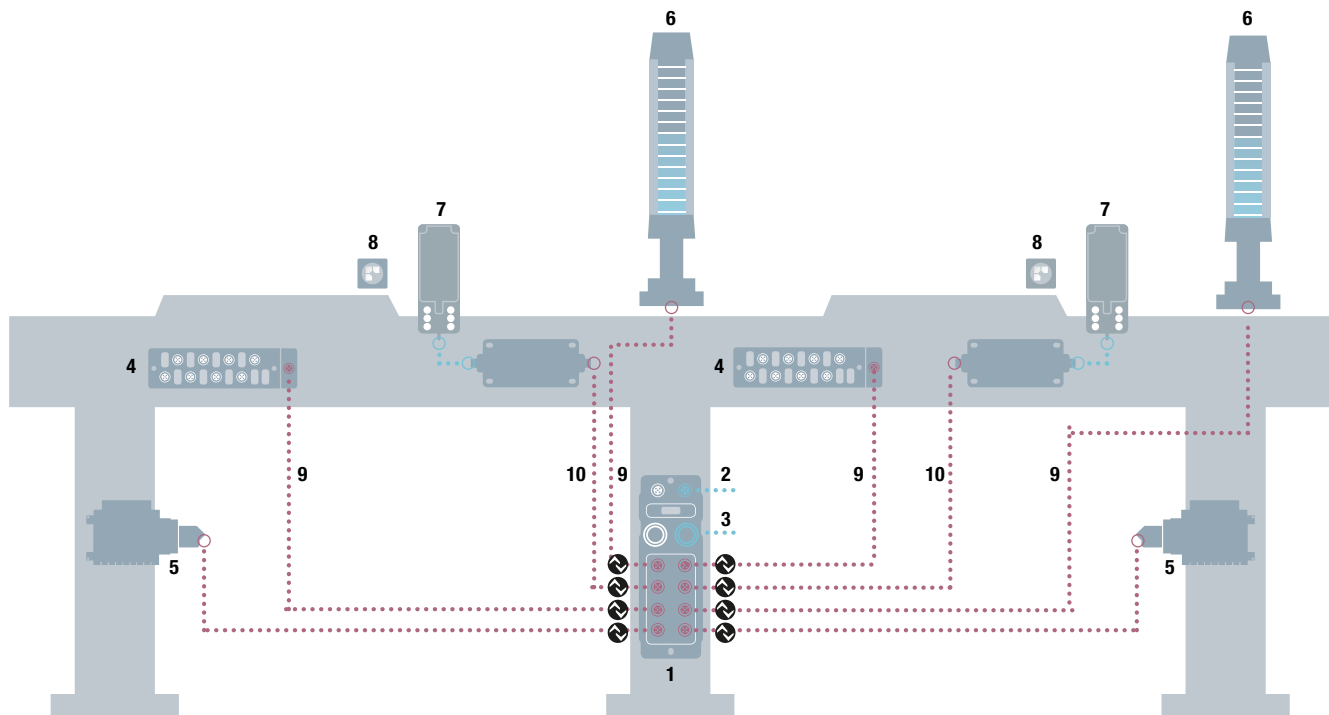

- 1 IO-Link master
- 2 Fieldbus cable
- 3 Power cable, 7/8"
- 4 M8 sensor hub, 16 inputs, PNP
- 5 IO-Link valve interface (Festo, Bosch Rexroth)
- 6 IO-Link SmartLight, 3 segments
- 7 Industrial RFID, read/write head
- 8 Industrial RFID, data carrier
- 9 Single-ended cordset, M12 → M12, 4-conductor
- 10 RFID single-ended cordset, M12 → M14, shielded, 4-conductor

In the entire production process

WE SPEAK IO-LINK

 *innovating automation*

Balluff IO-Link ensures transparency for all areas of automation – logistics, service, production, assembly, inspection and packaging – and for every single application including fluids, identification, travel measurement and object detection.

At Balluff you get holistic IO-Link solutions with high performance IO-Link sensors and the best IO-Link network and connectivity. Balluff speaks IO-Link in every field and with all principles of operation, so you have access to these IO-Link advantages throughout the entire system.

- Easy to install
- Requirements-based maintenance
- Efficient operation
- Highest machine availability

This lets you exploit all the possibilities of this digital communication standard. In the following you will see specifically all the ways you can use IO-Link performance.

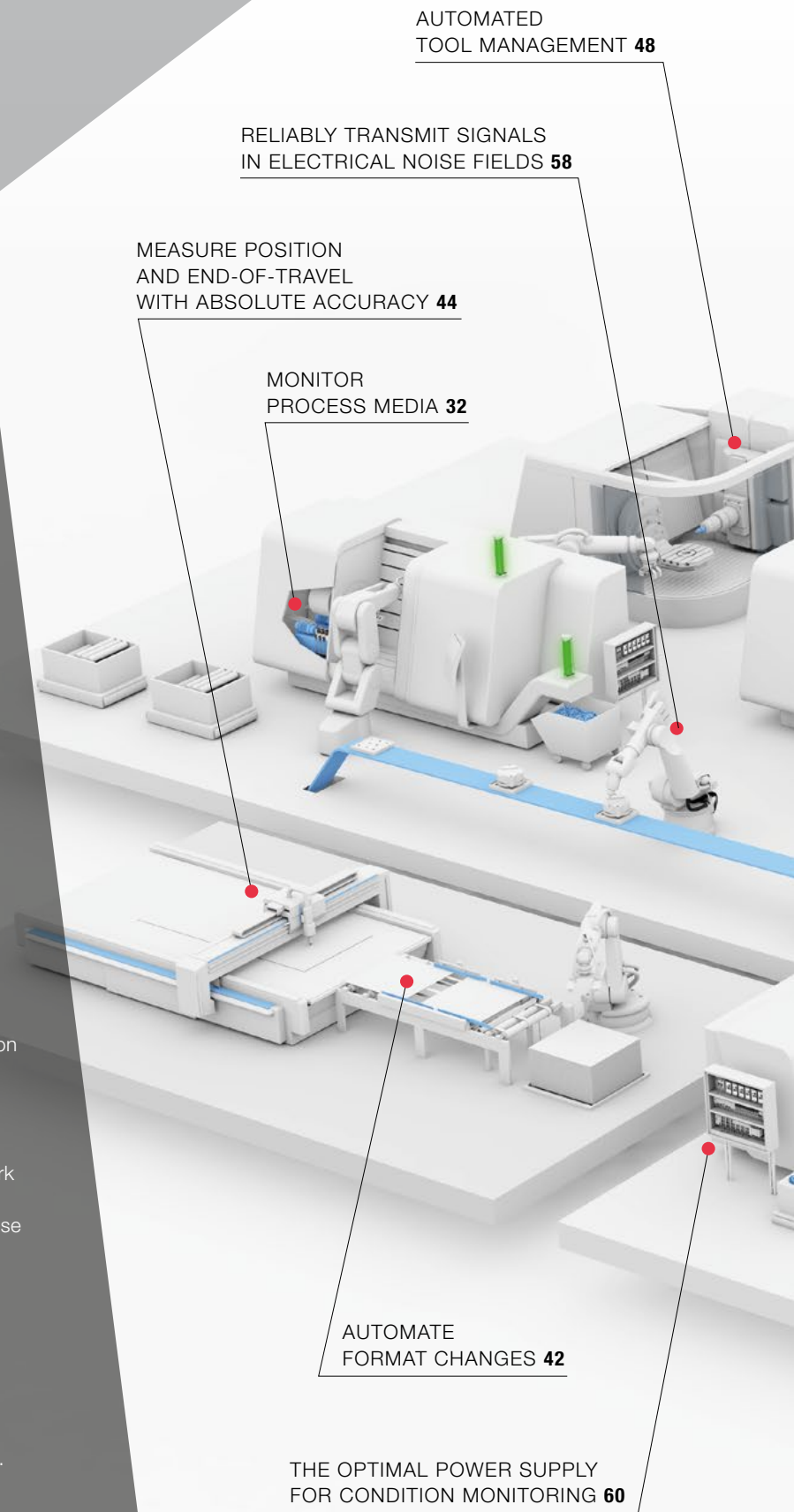

AUTOMATED
TOOL MANAGEMENT 48

RELIABLY TRANSMIT SIGNALS
IN ELECTRICAL NOISE FIELDS 58

MEASURE POSITION
AND END-OF-TRAVEL
WITH ABSOLUTE ACCURACY 44

MONITOR
PROCESS MEDIA 32

AUTOMATE
FORMAT CHANGES 42

THE OPTIMAL POWER SUPPLY
FOR CONDITION MONITORING 60

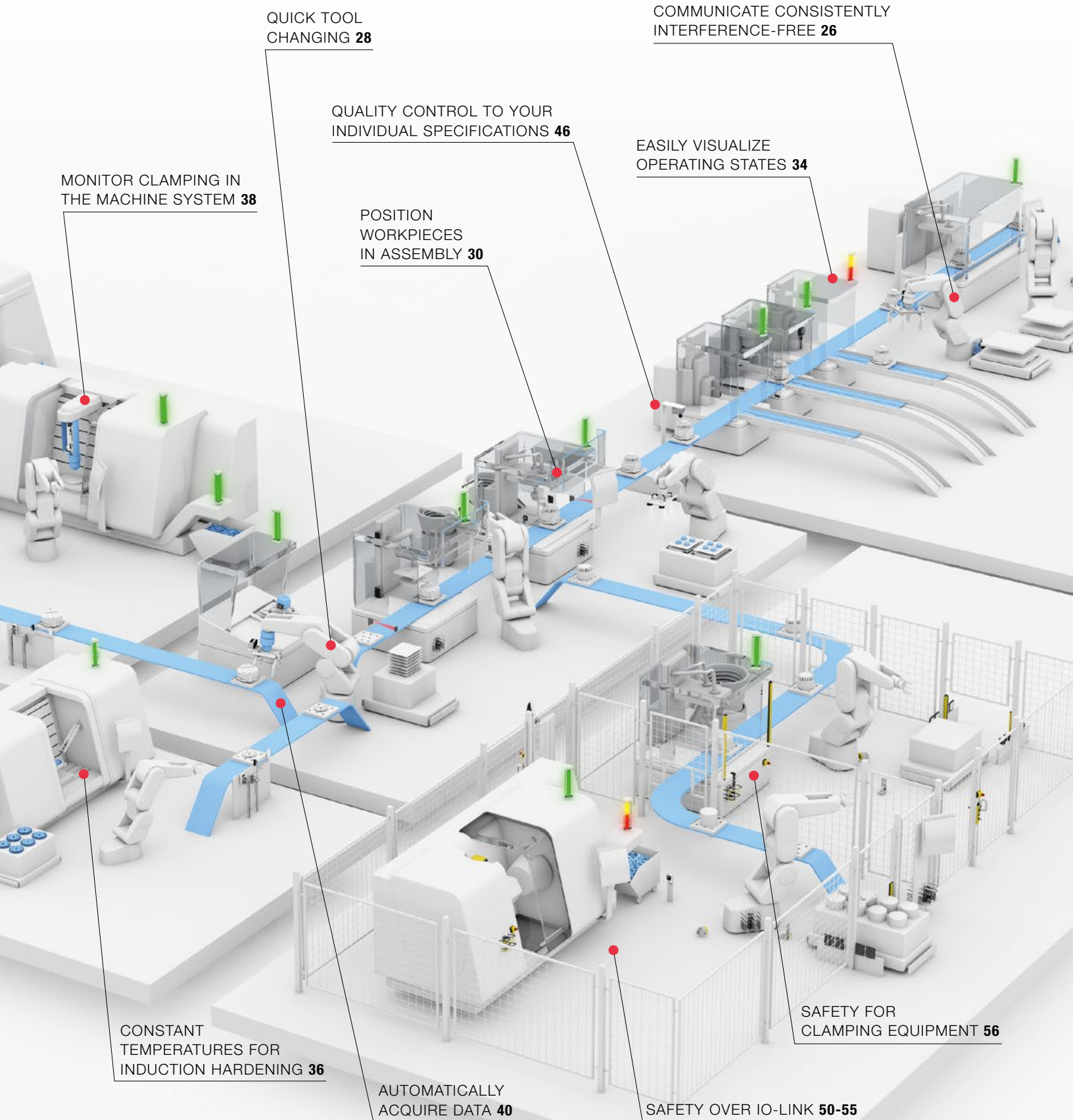

QUICK TOOL
CHANGING **28**

MONITOR CLAMPING IN
THE MACHINE SYSTEM **38**

QUALITY CONTROL TO YOUR
INDIVIDUAL SPECIFICATIONS **46**

POSITION
WORKPIECES
IN ASSEMBLY **30**

COMMUNICATE CONSISTENTLY
INTERFERENCE-FREE **26**

EASILY VISUALIZE
OPERATING STATES **34**

CONSTANT
TEMPERATURES FOR
INDUCTION HARDENING **36**

AUTOMATICALLY
ACQUIRE DATA **40**

SAFETY OVER IO-LINK **50-55**

SAFETY FOR
CLAMPING EQUIPMENT **56**

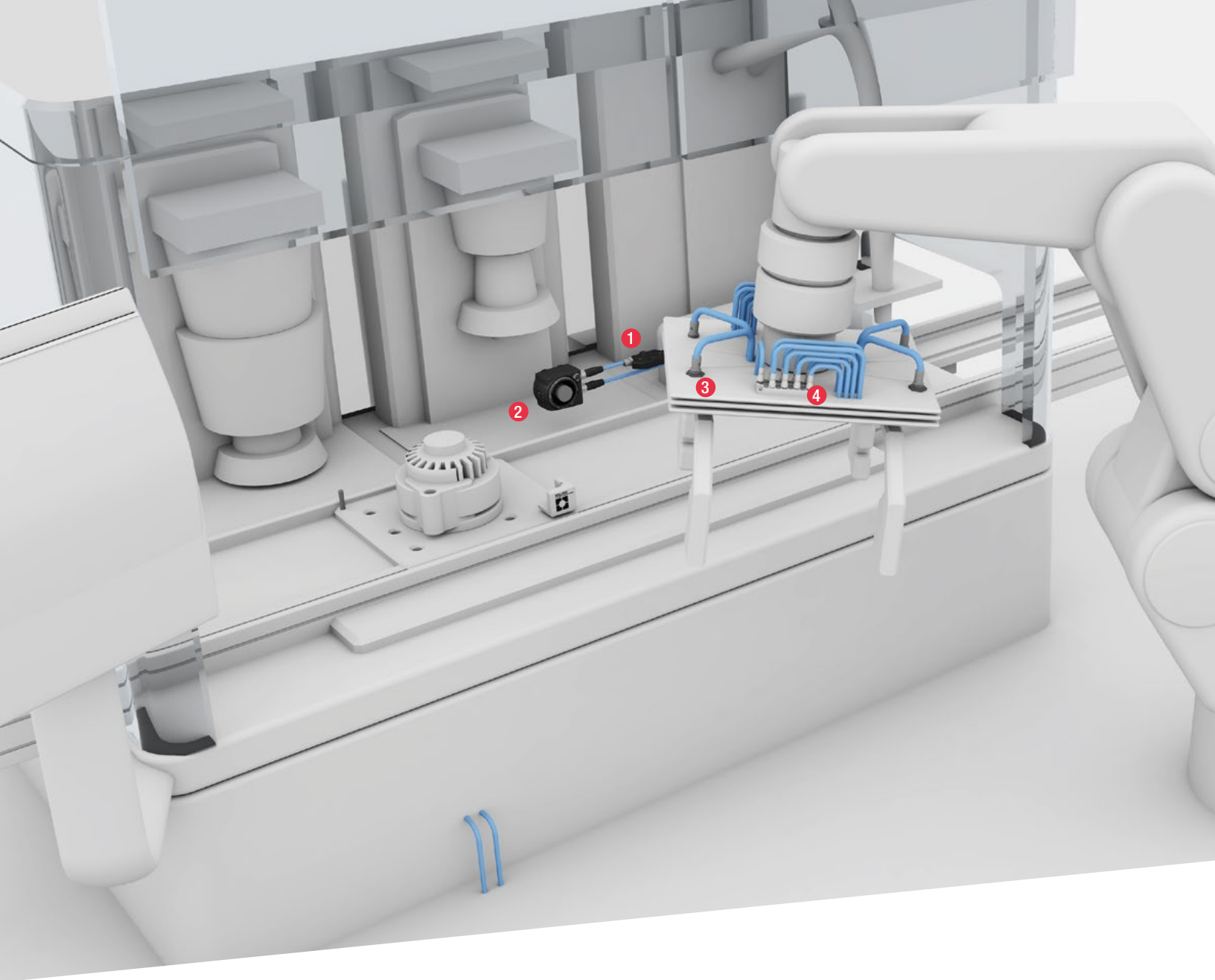

All devices become IO-Link capable

Modern robotics equipment requires many sensors – especially in the robot arm which, because of the dynamics and energy consumption, still needs to have as little mass as possible. Another difficulty is the cumbersome wiring of multi-conductor cables.

Not so with IO-Link because this digital communication standard requires only a traditional industrial cable which is simple to install. IO-Link also ensures noise immunity with intelligent devices without the need for shielded cables.

Whether you use Profibus/Profinet over CC-Link/CC-Link IE-Field, DeviceNet or Ethernet/IP and EtherCAT, our IO-Link masters let you use IO-Link with any controller. After all, IO-Link is fieldbus-neutral. With IO-Link you can bring a wide variety of devices together so that even the most complex tasks, including robotics and beyond, can be simply mastered with the greatest possible flexibility.

The universal IO-Link interface integrates intelligent devices into the controller. You can also integrate standard analog sensors into the controller using our IO-Link analog converters. Or you can simply connect them to our IO-Link hubs, which can digitize the analog input signals and pass them on to the IO-Link master. With the IO-Link master you can also control actuators and valve terminals. Simply use the valve interface to connect the valve terminal to the IO-Link master. Here again, all you need is a standard cable to make use of the full functionality.

A Balluff IO-Link sensor hub bundles the signals from up to 16 sensors or actuators. With our cascadable hubs with expansion port you can connect an additional sensor hub or a valve terminal. If these hubs are cascaded with an additional hub and connected to our 16x IO-Link master, a module transmits up to 496 inputs/outputs.



Simplify network topology

Communicate
consistently
interference-free

- 1 Universal IO-Link interfaces
- 2 Vision sensors
- 3 IO-Link ultrasonic sensors
- 4 IO-Link sensor/actuator hubs
- 5 IO-Link masters
- 6 IO-Link valve interface
- 7 Photoelectric IO-Link multifunction sensors

Contactlessly transmit power and data

Quick tool changing

Maximum flexibility since the robot radius is increased to 360 degrees

Inductive couplers are a windfall for robotics because they send both data and power at the same time over an air gap. How do you benefit? Greatly, and in many ways – the risk of cable breaks is fully precluded, mechanical contacting of mechanical connectors is eliminated, and the robot has a continuous radius of movement of 360 degrees.

Our inductive couplers with IO-Link guarantee you fast gripper changes and increase the up-time of your system. This is because the signal is transmitted directly following the gripper change so that production can continue without interruption. The speed and flexibility support frequent format changes. The result is that you can produce even small batches efficiently. Another attractive feature: no mechanical wear means inductive couplers are maintenance-free.

The quick-disconnect units provide the greatest flexibility for your machine design. Even hard-to-access components are simple to connect with IO-Link. This is because all IO-Link-capable devices now connect to the IO-Link master and to the controller flexibly and without contact.

The bi-directional inductive data couplers allow the data to be sent in both directions, and you can simultaneously control actuators and valve terminals while collecting signals. These variants support the full IO-Link functionality so that intelligent sensors and actuators can be configured and diagnosed without contact.

- 1 Inductive couplers (style Q40)
- 2 IO-Link SmartLight



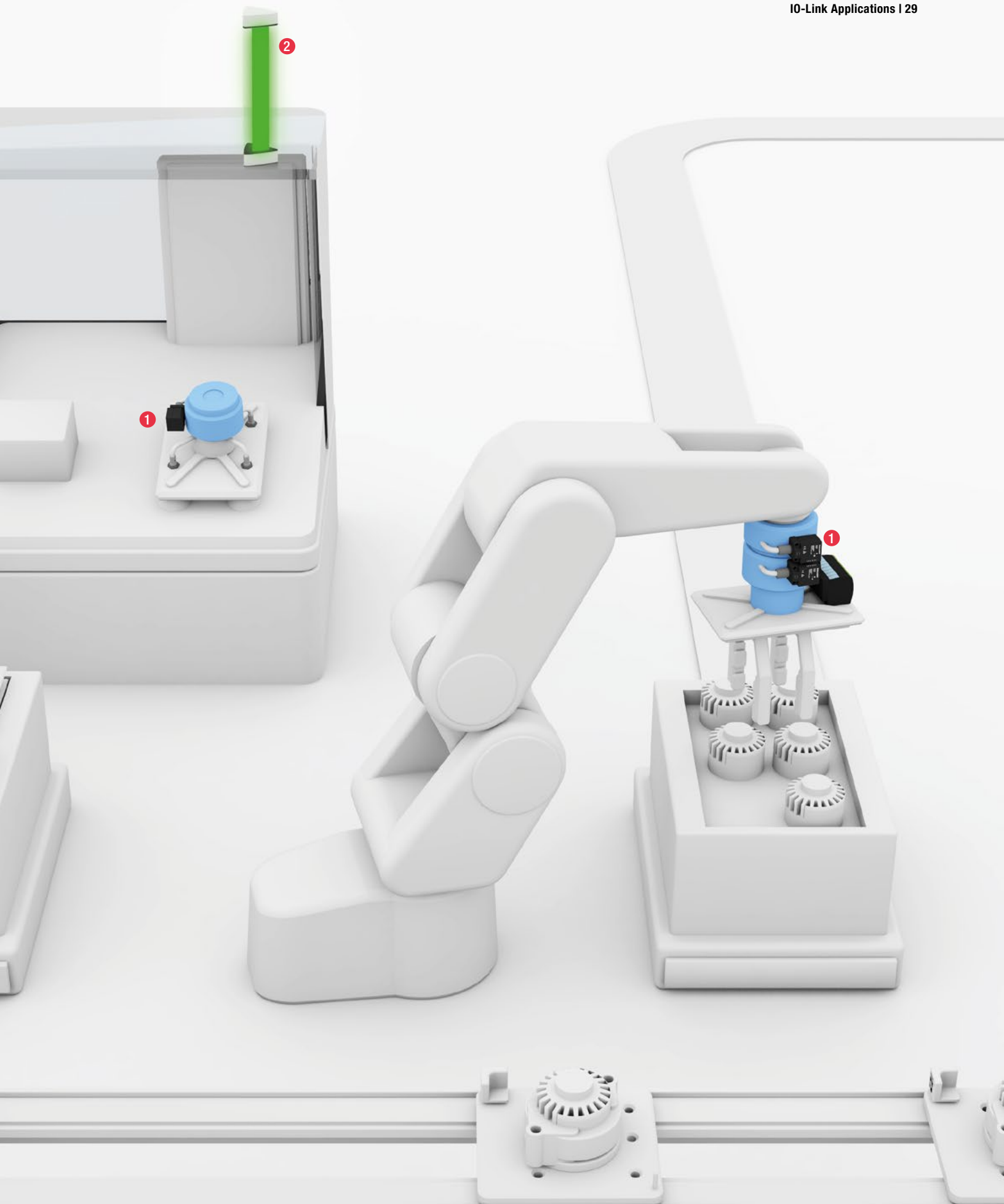

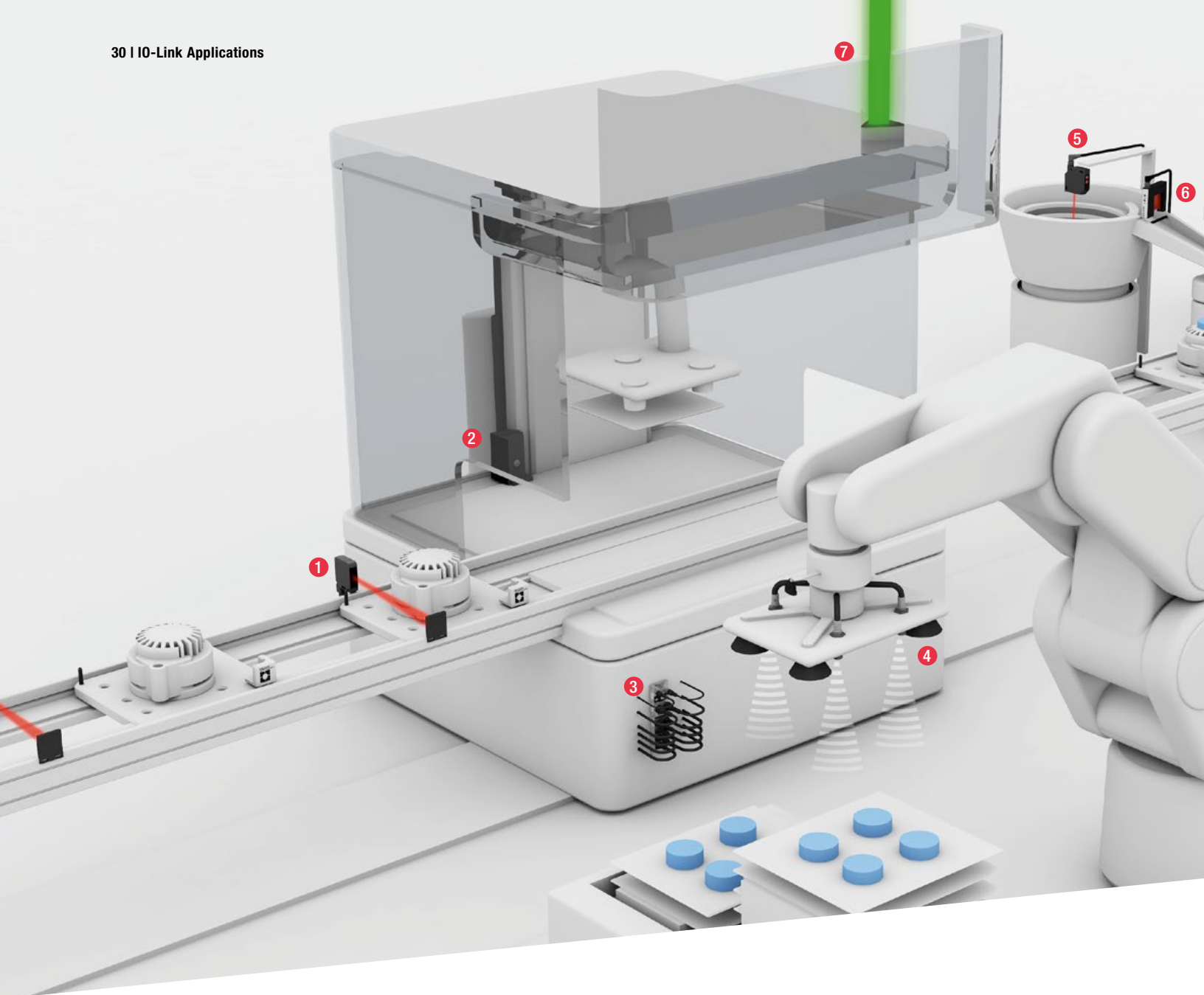

Smart diagnostics increase reliability

When it comes to Industry 4.0, generating, transporting and processing information are indispensable parts of the process. This makes local, intelligent sensors all the more important. Our photoelectric, multi-function sensors detect actual operating states while collecting and processing information. And via IO-Link they provide far more data than just the switching signal.

The BOS 21M ADCAP multi-function sensor with red light is ideal for optimally positioning your workpieces for assembly. For the best functionality, you can use IO-Link to conveniently select between four different sensor modes. This allows you to utilize the best and most reliable detection method depending on your application.

The sensor simultaneously sends diagnostic data as well. Now you can evaluate the light emissivity value provided and detect increasing contamination of the sensor. This permits

maintenance and cleaning schedules to be designed so the sensor is always cleaned at just the right time before failures can occur. You also know whether the sensors are still optimally adjusted after a cleaning.

The BOS 21M ADCAP can do even more: it continuously monitors light intensity and brightness of the LED emitter beam so that faulty switching of the sensor is virtually eliminated. The built-in count function with various counting and reset modes also allows the quantity to be checked in the controller without any additional programming effort.

If your detection requirements are even more demanding, we offer our photoelectric, high-precision laser BOS 21M HPL with numerous additional functions. Thanks to various detection and processing modes, this high-performer also detects complex objects and the smallest details with absolute precision.



Full transparency all the time

Position workpieces in assembly

- 1 Photoelectric IO-Link multifunction sensors
- 2 Multiple position switches
- 3 IO-Link masters
- 4 IO-Link ultrasonic sensors
- 5 IO-Link color sensor
- 6 IO-Link fork sensor
- 7 IO-Link SmartLight



For high production quality

Monitor process media

Plug-and-play sensor replacement: high machine availability

Pressure sensors are indispensable when you need to monitor process media such as coolants and lubricants, hydraulic fluids and pneumatics. The system pressure affects things such as the surface quality when processing workpieces. Continuous and exact regulation of the pressure is provided by our IO-Link pressure sensors, which are continuously transmitting their measurement values and data to the controller.

Pressure sensors also ensure the best results on a machining center where they provide clamping distance monitoring to guarantee secure holding of the workpiece and tool in the lathe.

IO-Link pressure sensors are configured via the controller, so that they can be installed where the action is or in hard-to-reach places for measurements and perfectly matched to the machine design. This guarantees you fast and precise results and reduces your costs, since you can now reduce cumbersome mechanical installation of hydraulic lines to a minimum.

IO-Link pressure sensors ensure that you enjoy the greatest possible machine up-time. Replacing a sensor is plug-and-play, since the data for the replaced sensor is automatically loaded into the IO-Link master.

Depending on your requirements, you can choose between IO-Link pressure sensors with display and IO-Link pressure transmitters without display. This ensures you the best and most economical solution for your workplace.

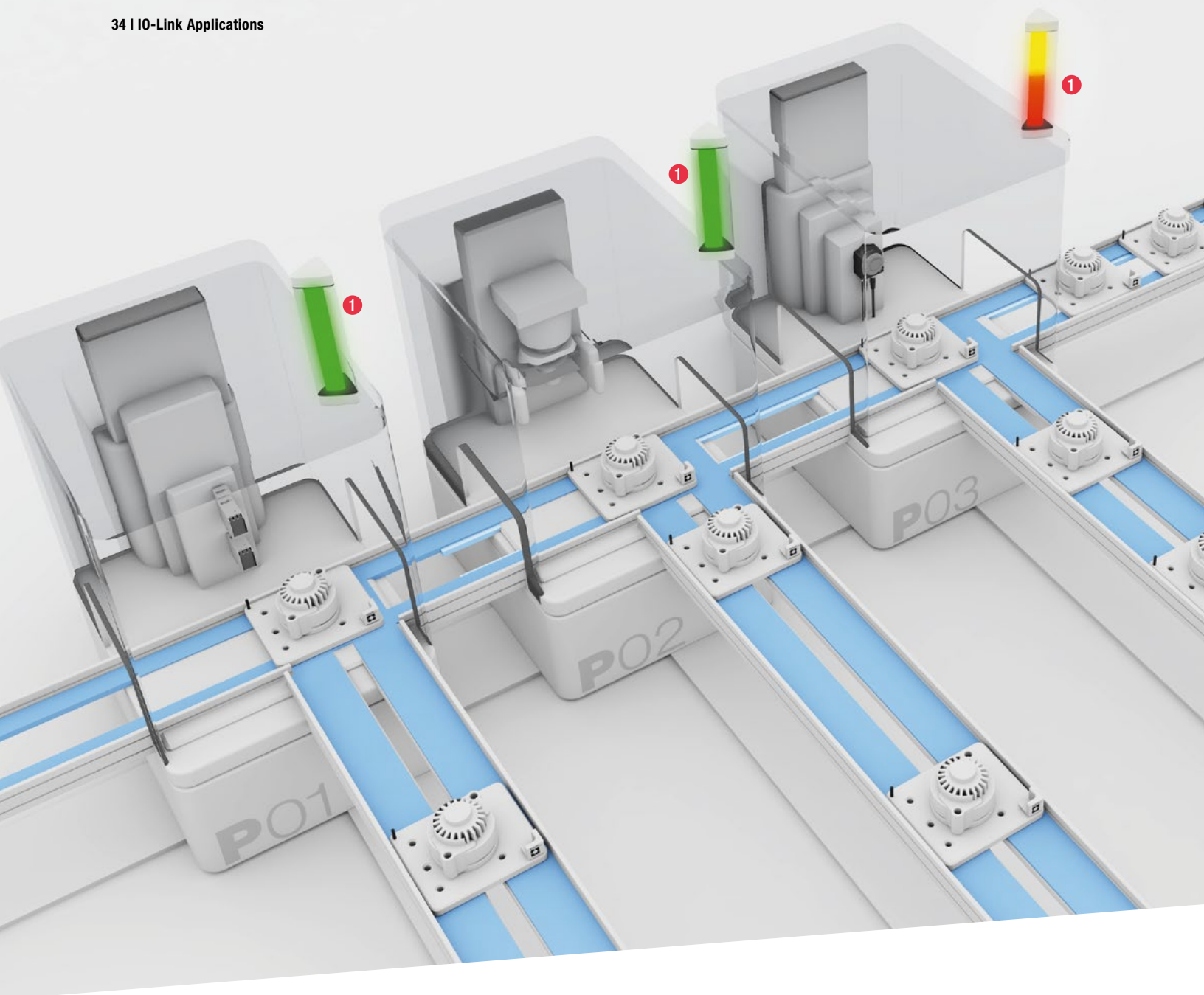

One light. Many functions. Unlimited uses.

It's not yet possible to foresee all the demands of the smart factory. But to visualize your automation, you can get a modern IO-Link device today that has virtually unlimited application and is ideally equipped for the future.

The LED stack light with IO-Link interface offers you a previously unimagined flexibility because with the Balluff SmartLight you can represent operating states in detail. In addition, you can even see trends and progressions. The SmartLight features three different modes:

- Segment mode: Display a wide range of color signals in freely configurable segments
- Level mode: Color progression display for representing variables such as level, position or temperature
- Run light mode: An automatic run light with freely programmable foreground and background color

The best part is you can change to any mode on the fly. Colors can also be changed while running because you configure the SmartLight simply from the controller. So forget the cumbersome mechanical reconfiguration of traditional stack lights. Unlike those older systems, you can individually specify the colors and zones for number, size and color definition.

Like all IO-Link devices, the SmartLight is simple to connect and install. A 3-conductor sensor cable is all you need to quickly connect it to your system and have immediate access to the full functionality.

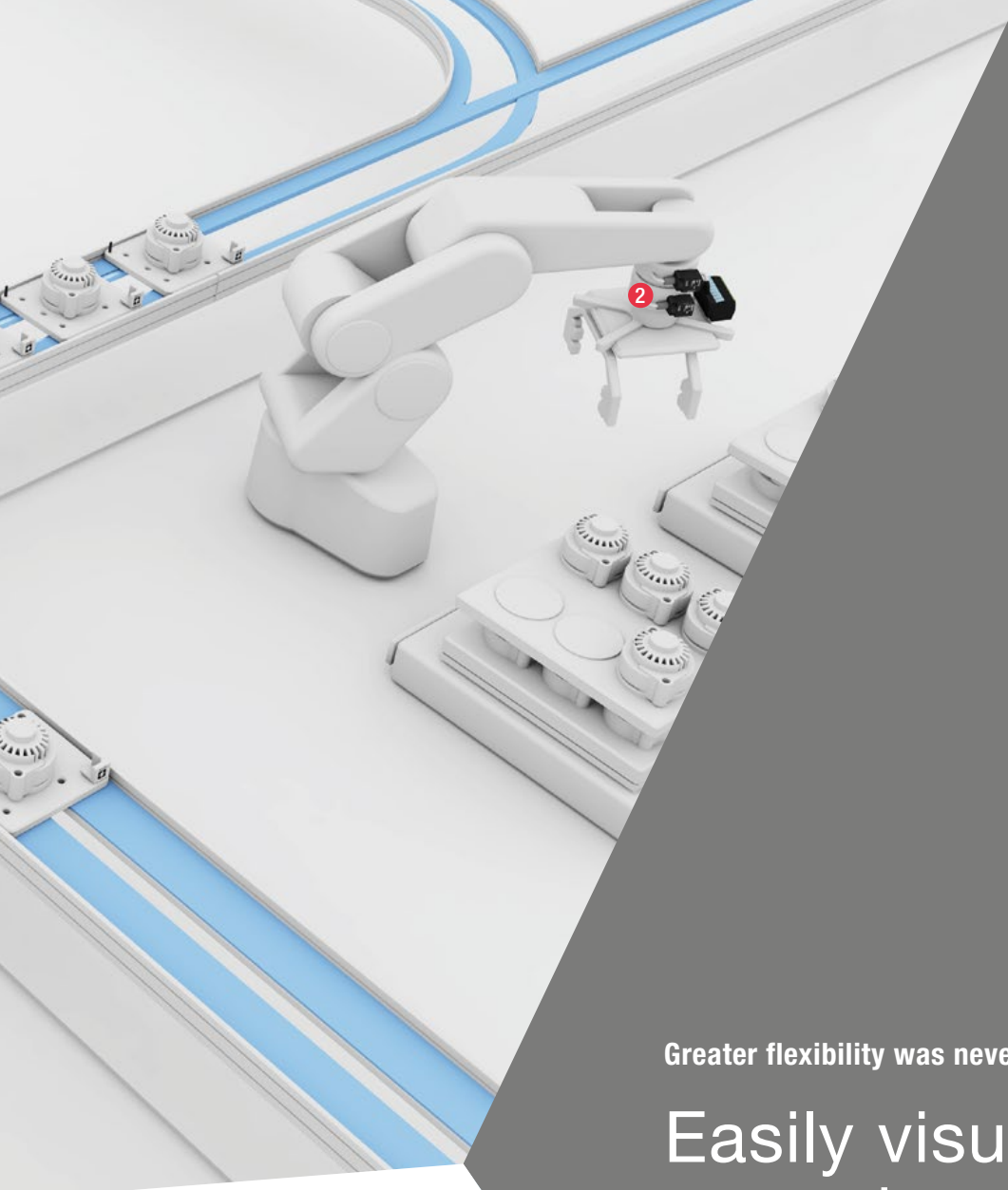

Greater flexibility was never easier

Easily visualize operating states

- 1 IO-Link SmartLight
- 2 Inductive couplers (style Q40)

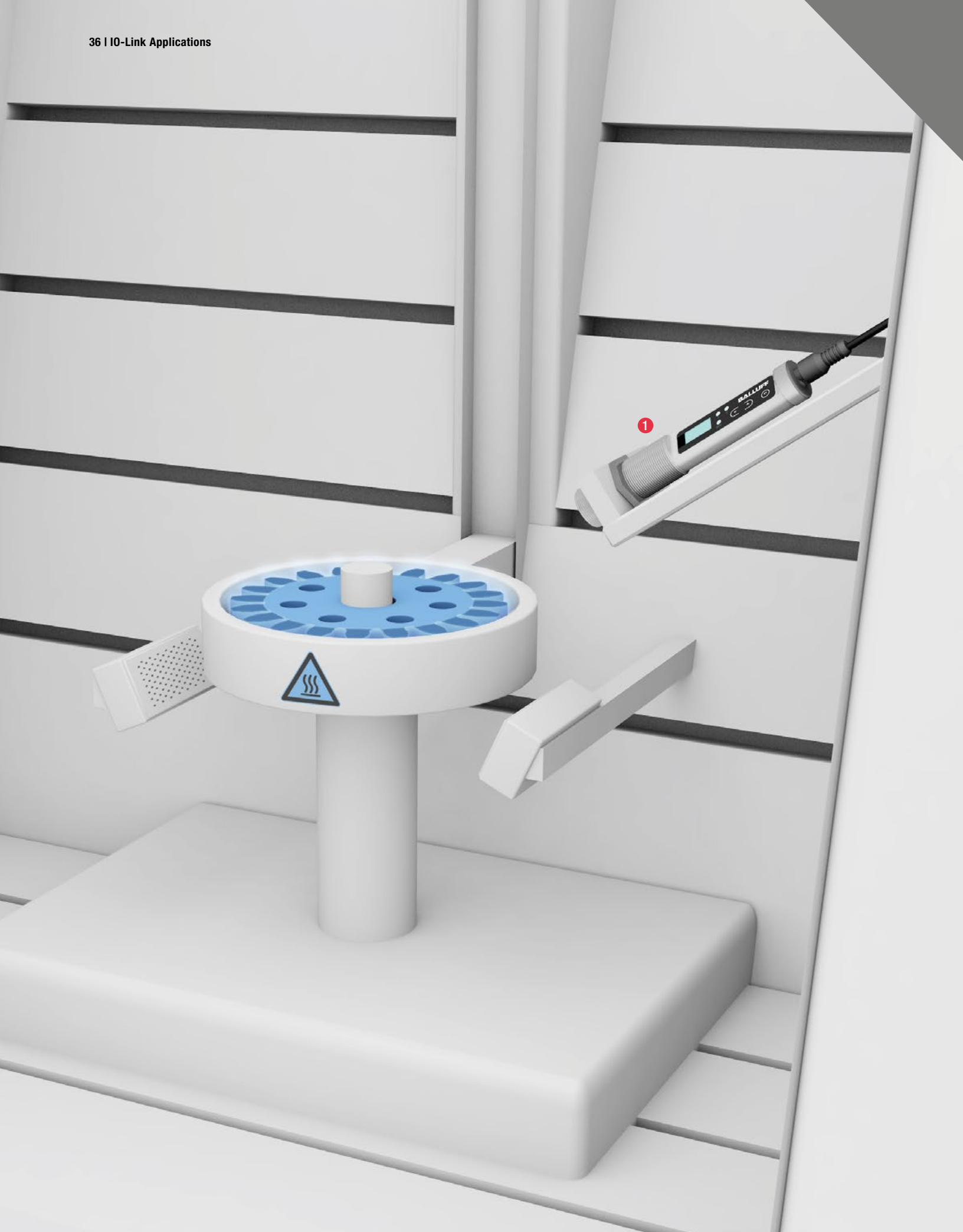

Reliable condition monitoring: high product quality

Constant temperatures for induction hardening

Sensor right where the action is

Monitoring temperatures during the hardening process is extremely important for not damaging the workpiece and ensuring the required product quality. Whether you process your parts by annealing or induction hardening, our infrared temperature sensors will help give you full control over your quality. Our sensors in the rugged M30 stainless steel housing handle this job reliably and without contact. And at a temperature range from 250 to 1250 °C, they detect hot objects even while moving. Our temperature sensors make it possible to significantly reduce the process time.

An important value in non-contact temperature detection is the emissivity. You can teach this with just a key press if you know the object temperature. This is simpler than determining the exact emissivity values and adds the advantage of setting up the machine in a much shorter time.

IO-Link lets you install the non-contact sensors just where they are needed, since you can configure all the functions and parameters remotely from the controller. No setting changes are necessary at the sensor location when products are changed. The appropriate configuration sets can be updated and loaded at any time via IO-Link.

This communication standard enables consistent diagnostics. You can query the device status at any time through the IO-Link interface. In addition, the information related to ambient conditions provided by the sensor via IO-Link can be logged and documented, including the temperature values for the hot workpieces.

Continual, non-contact linear position measurement

Monitoring clamping in the machine system

Greatest process security – even in a harsh industrial environment

Compact, precise tool spindles, clamping cylinders and tool changers on a machining center play a central role in the work process. This is why reliable and wear-free monitoring of the ongoing clamping process in the machine system is so critical.

Meet this demanding challenge simply with the new IO-Link positioning system. It features an absolute measuring principle and transmits an additional out-of-range bit. This tells the controller that the target has left the measuring range, thereby increasing reliability. You can set up to three switching signals and internal temperature detection is also possible. The high linearity and precise repeat accuracy of the measuring system give you reliable results.

The non-contact measuring system in the fully potted housing will ensure the highest process reliability and automation quality even in the harshest industrial environments. Also advantageous here is the high level of electromagnetic compatibility. You can use our inductive IO-Link positioning system in many different ways thanks to its configurable measuring range. And the compact size means it can be installed even where space is at a premium.

Its digital IO-Link signal means the positioning system is guaranteed to be noise-immune even when using unshielded cables. Thanks to IO-Link, you can eliminate an analog input card.

- 1 IO-Link inductive positioning systems
- 2 IO-Link inductive distance sensors

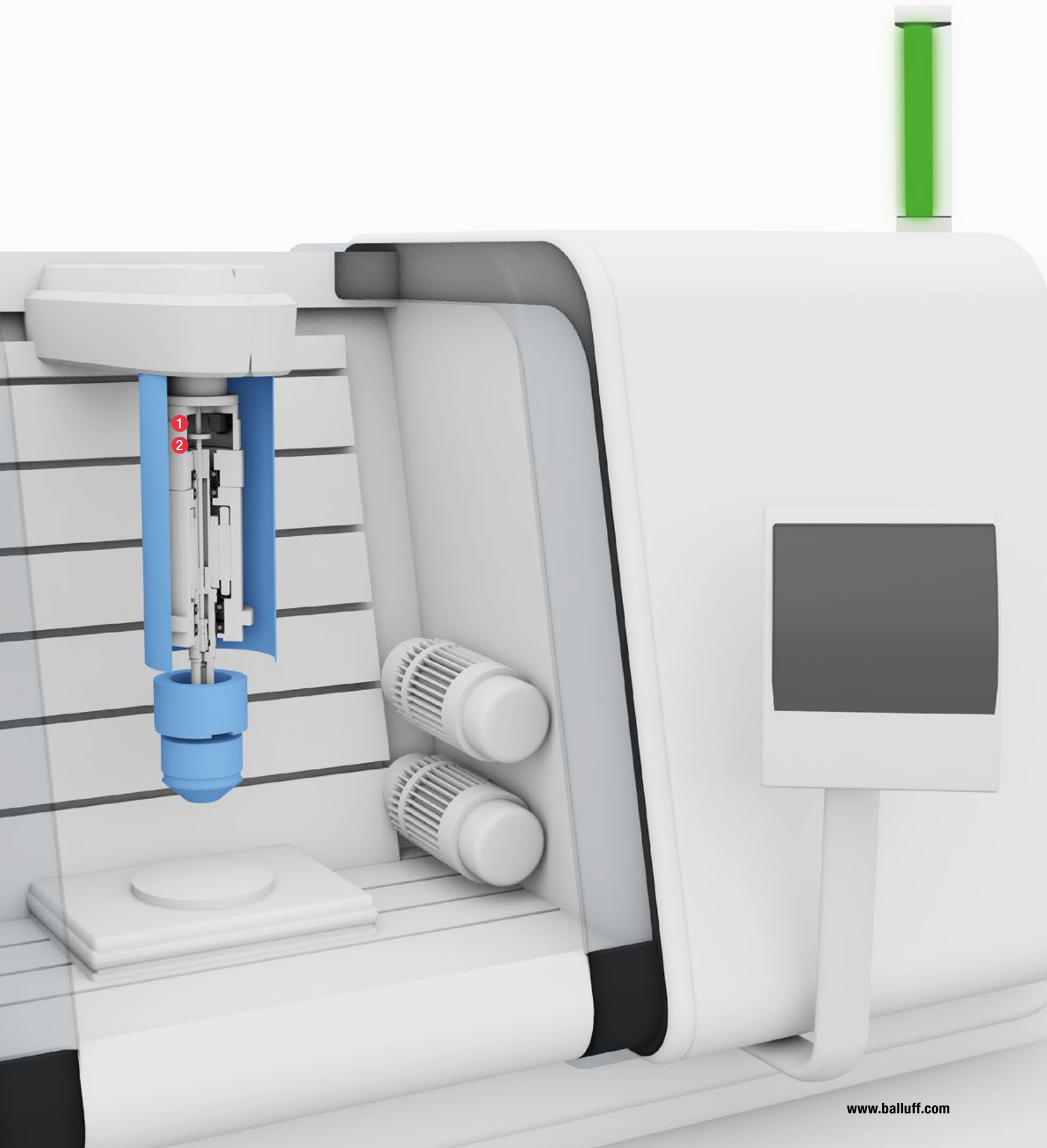

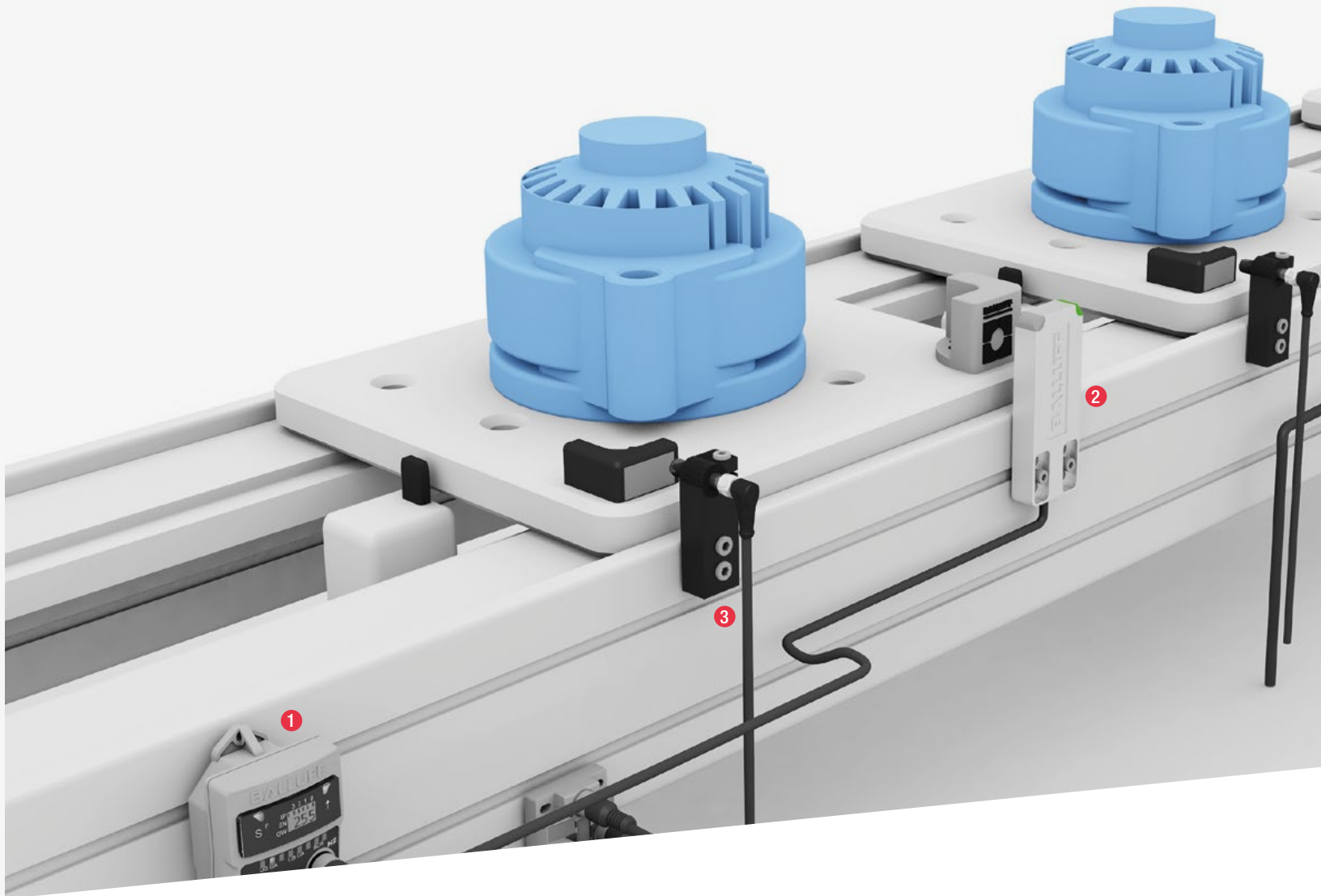

Increases product quality, optimizes the process

When your automation calls for parts tracking, there is no alternative to RFID. These self-controlling systems record and document all the data in real time. They make every production step, material used and operating resource traceable, so that corrections are possible while the process is still running. The comprehensive transparency provided by RFID represents the prerequisite for process optimization while ensuring high product quality.

Our rugged BIS V processor unit provides fast data transmission, short cycle times and increased data security in all applications. This lets you use different RFID technologies – LF, HF and UHF – at the same time on a single processor unit. Just one type of processor unit is all you need to handle any application. Whatever industry you are in, this high-performer features perfect electromagnetic compatibility and works with all common bus systems.

BIS V comes with four ports which can be individually configured and operated simultaneously with up to four read/write heads. In addition, you can connect IO-Link capable sensors and actuators or a sensor hub with up to 16 sensors to the integrated IO-Link master port. Now you can bundle sensor data in the simplest way possible in any network technology. Your network structure becomes more efficient, while you save time and money.

Alternately, you can use IO-Link ID systems. As easy to connect to the IO-Link master as a sensor, they require no processor unit. The bottom line: IO-Link makes parts tracking especially economical.

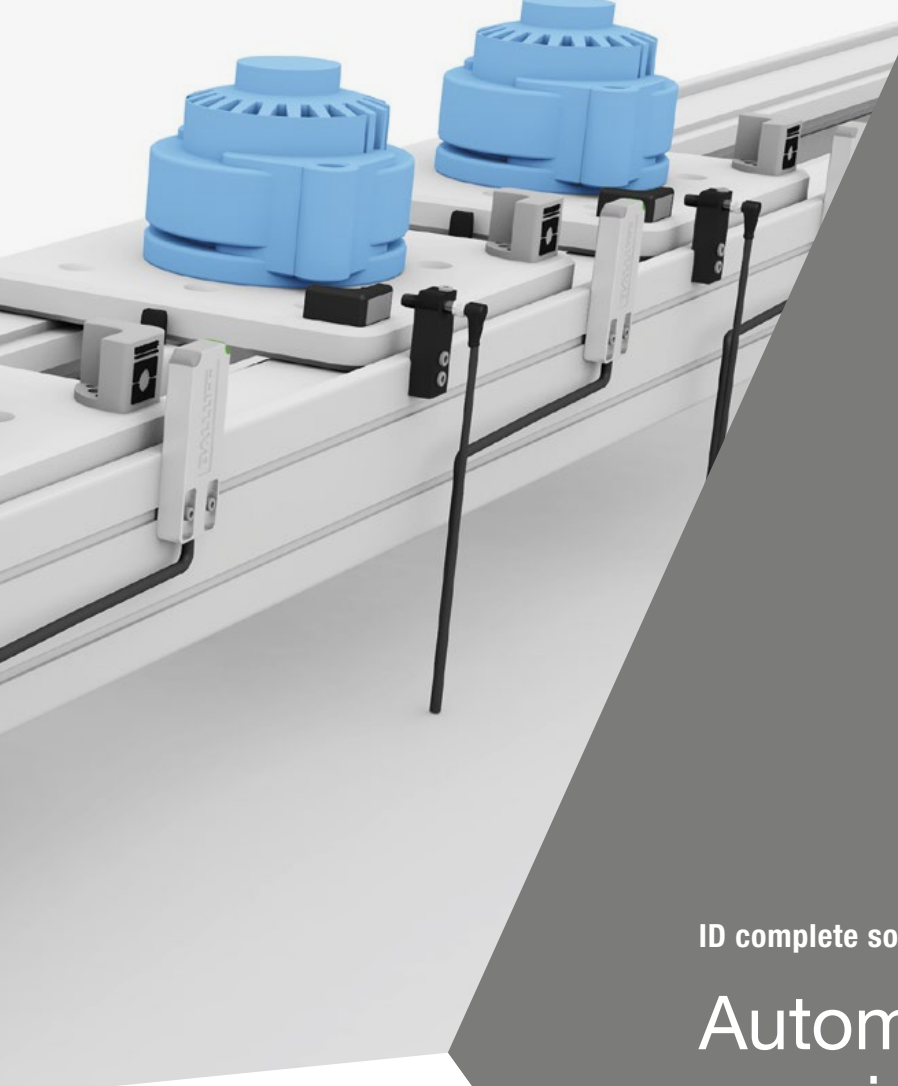

ID complete solutions for transfer systems

Automatically acquire data

- 1 BIS V processor unit with IO-Link master
- 2 BIS L IO-Link read/write heads
- 3 BIS M-Link IO-Link read/write heads

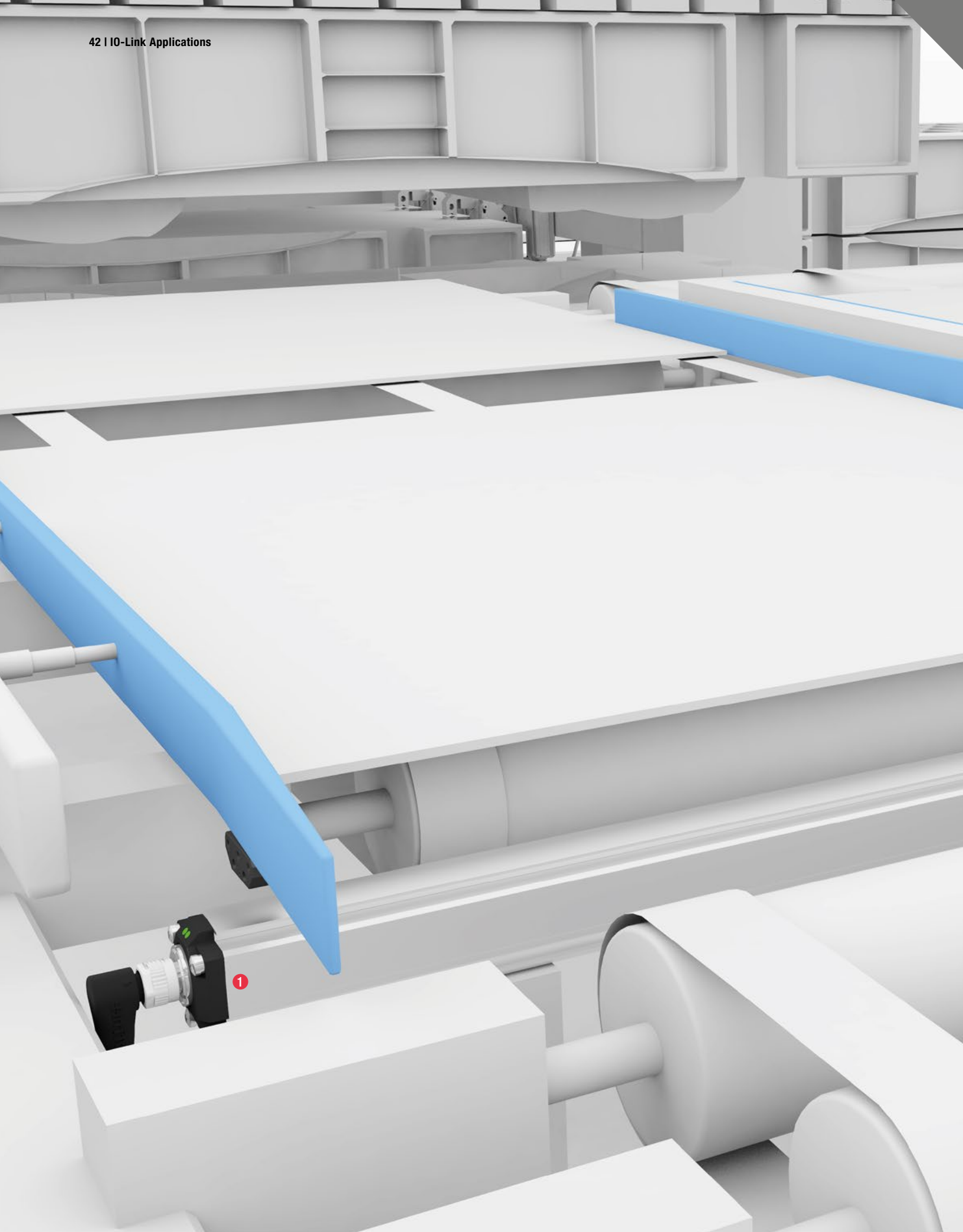

A background image showing industrial machinery, likely a conveyor system, with white and blue components. The image is partially obscured by a dark grey diagonal shape in the top right corner.

Fast parameter replacement, minimum scrap

Automate format changes

React quickly and flexibly to changing requirements

Ever smaller lot sizes mean your production has to be able to respond ever faster to changing customer demands and in a flexible way, since different sizes and formats are involved in feeding, processing and packaging the material.

The position and spacing of the adjustment points, such as transport belts and guide rails, need to be reset each time the product format is changed. Using position measuring systems for format changing shortens the change time, increases product quality and reduces scrap to a minimum.

Our magnetostrictive linear position sensors with IO-Link interface provide high-precision, fast and absolute position detection for your individual format settings. The rugged design with a hermetically sealed housing makes it completely impervious to contamination, shock and vibration. You will profit from high machine and system up-time even under extreme ambient conditions. Simultaneously querying multiple positions with a single positioning system saves you additional integration effort and cost.

IO-Link gives you multiple benefits. Incorporation into the control system and replacing the parameters using the defined protocols is simple and time-saving. Plug-and-play makes system interchanging quick and easy. The system is up and ready again immediately with no homing move for a maximum stroke length of 4572 mm.

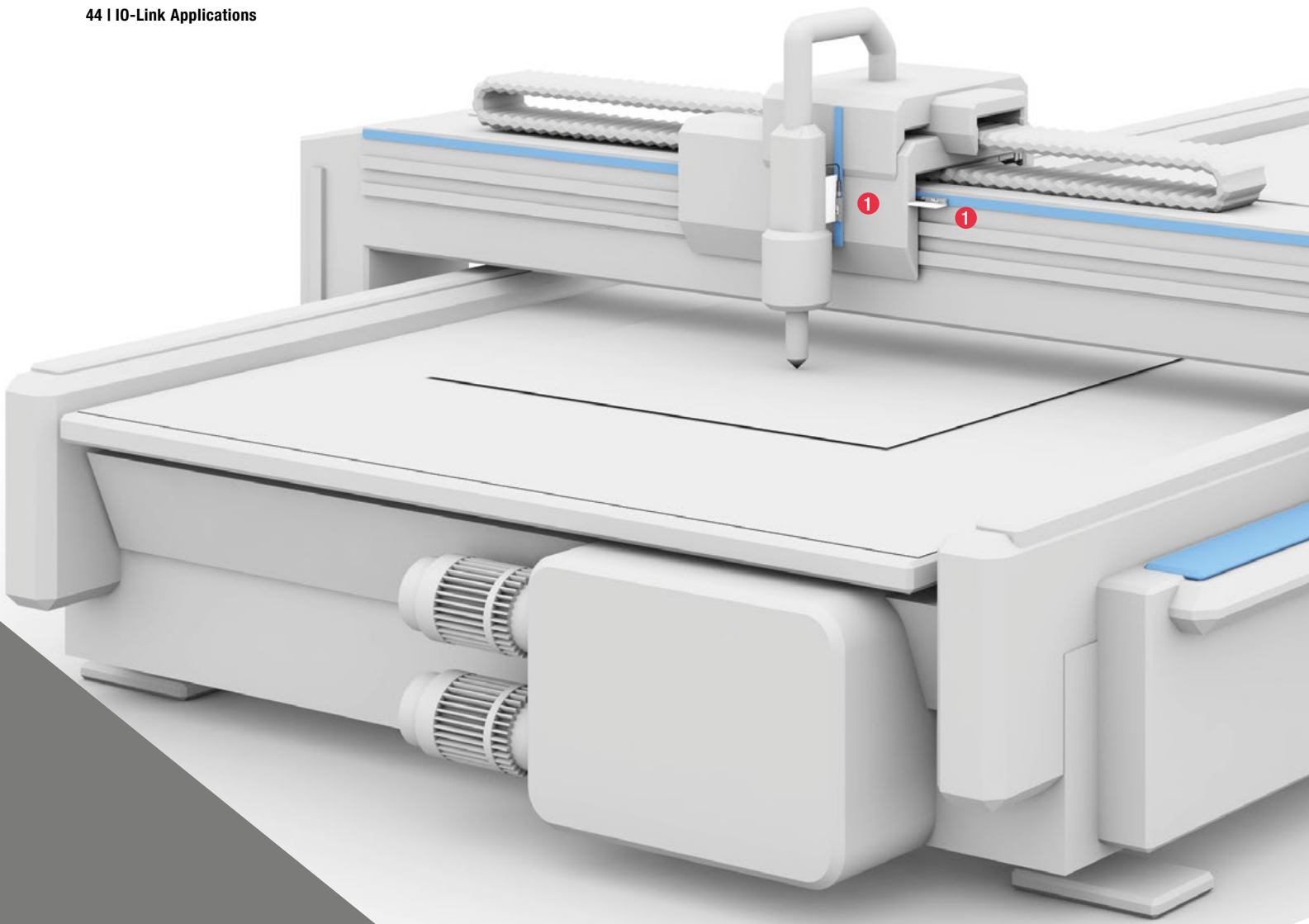

Simple handling, versatile application – economical!

Measure position and end-of-travel with absolute accuracy



Continuously monitor position during movement

When other travel measuring systems are too large, too slow, too imprecise, or too inflexible, you can count on the BML-SL1 absolute magnetic encoder. It stands out wherever you need absolute accuracy of positions and end-of-travel. Specifically developed for measuring and positioning tasks, it is fast, highly precise and can be used in any industry. The encoder is simple to use, extremely cost-effective and compact, making it easy to integrate.

Special flexibility comes from its built-in IO-Link interface. Additionally, IO-Link allows you to conveniently connect the measuring system; format setup and adjustment are also fast and easy using this communication standard because you can easily enter all the parameters from a central location. Using IO-Link you can output position information and easily view it on the controller. You can monitor the target position and continually check positions during the move.

With the BML SL1 you get all the advantages of a magnetic tape system and the innovative interface of the controller world.

1 BML SL 1 absolute linear magnetic encoder system

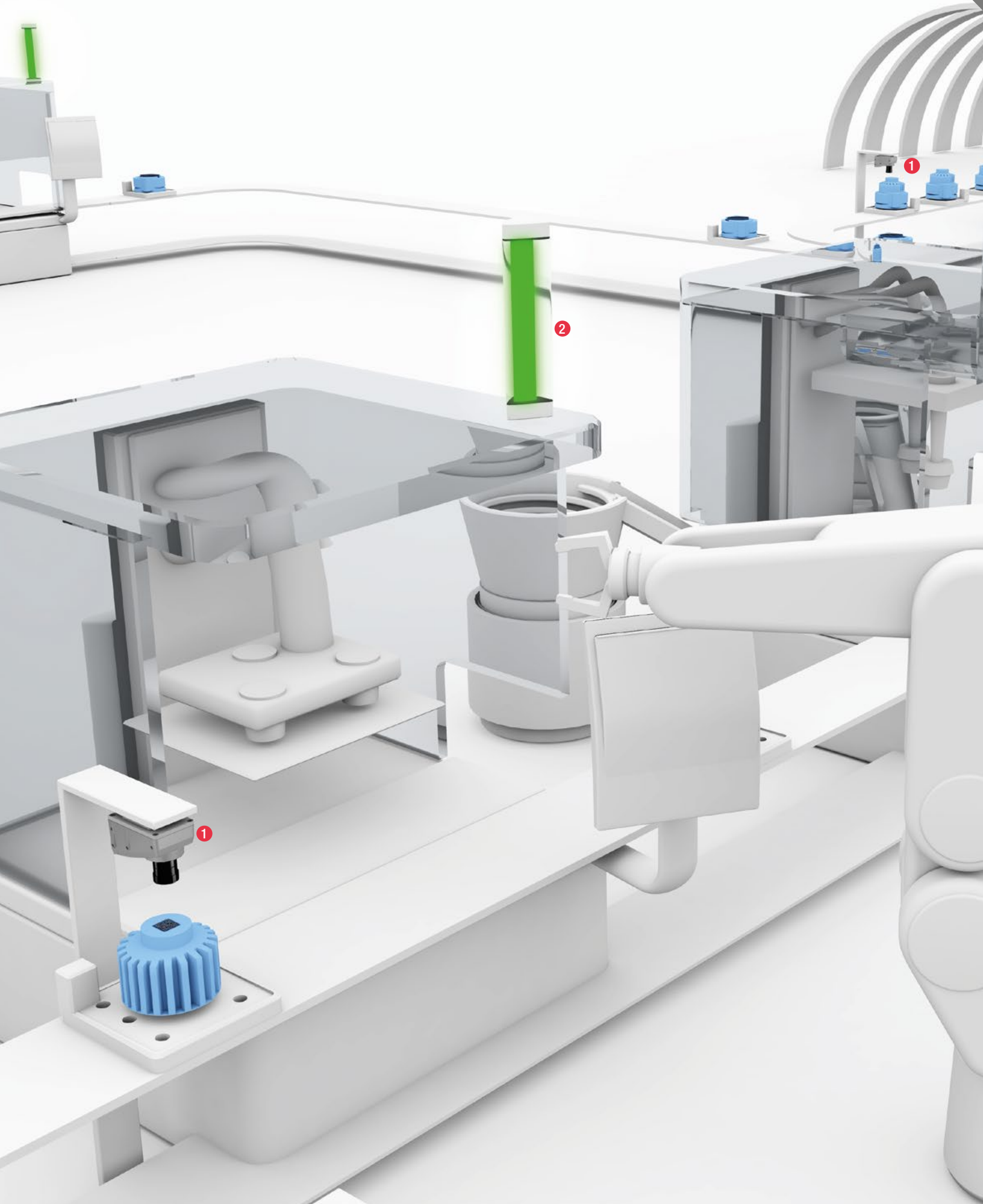



Simplify industrial vision applications

Quality control to your individual specifications

Well-positioned for Industry 4.0

For modern, flexible manufacturing our SmartCamera with fieldbuses and IO-Link offers you a wide range of applications. It takes care of visual quality controls of the finished parts including their production steps by, for example, checking whether size, distance and orientation are correct or whether the parts are complete and flawless. This means you can discover and correct process errors early in each individual production step. The result is less scrap and reduced follow-on costs.

To ensure an optimal process, the IO-Link interface allows additional sensors to be incorporated into the overall solution, so that with our camera you are well equipped to meet the challenges of Industry 4.0.

For example, through the IO-Link master interface you can also directly – without a PLC – display process control states using our IO-Link SmartLight stack light. The SmartCamera enables intelligent data management and provides for modern information storage. All the data is formatted as desired and passed on to the host control system.

The user-friendly interface ensures that all the tasks can be simply and quickly taught according to your individual specifications. The complete software with online help, as well as graphical interface, tool aids and the manual, are already integrated. We think you should be able to take brilliant images for granted.

You also stabilize your entire production process with our SmartCamera because it can be configured so that only the information needed for the controller flows through the process network. All the other data is directed to a separate Gigabit Ethernet network. This minimizes data load and secures your process network.

- 1 SmartCamera BVS SC with IO-Link master
- 2 IO-Link SmartLight

Automated tool management with RFID

Automated tool management

All the tools at a glance

When it comes to industrial automation and rugged RFID systems, Balluff has, for more than 30 years, secured the highest quality of tools and optimized their utilization. We offer systems which always provide the correct tool data to the CNC controller in milling machines and machining centers.

With RFID the right tool can be assigned to the right machine for any upcoming process. Each individual tool is independently directed through production, checked and, if necessary, reworked and returned. RFID guarantees you unique, unambiguous identification of every tool used, since the unique ID on the data carrier fixed to the tool holder is unmistakable. All tool-relevant data can be displayed via IO-link in the controller. This gives you high machining quality and optimal tool utilization. In this way RFID-assisted tool management contributes to greater value creation.

At Balluff you can choose from low-frequency (LF) and high-frequency (HF) systems which, thanks to the great variety of data carriers and read heads, lets you fulfill a wide range of applications even under challenging conditions. Our low-frequency BIS C has, over the years, established itself as a standard. With our high-frequency BIS M you can handle large data volumes. And if you need to work with both LF and HF, our solutions also provide reliable mixed operation of both frequencies. With Balluff you can choose a frequency-independent, cross-technology processor unit.

- 1 Easy Tool-ID
- 2 SmartCamera BVS SC with IO-Link master





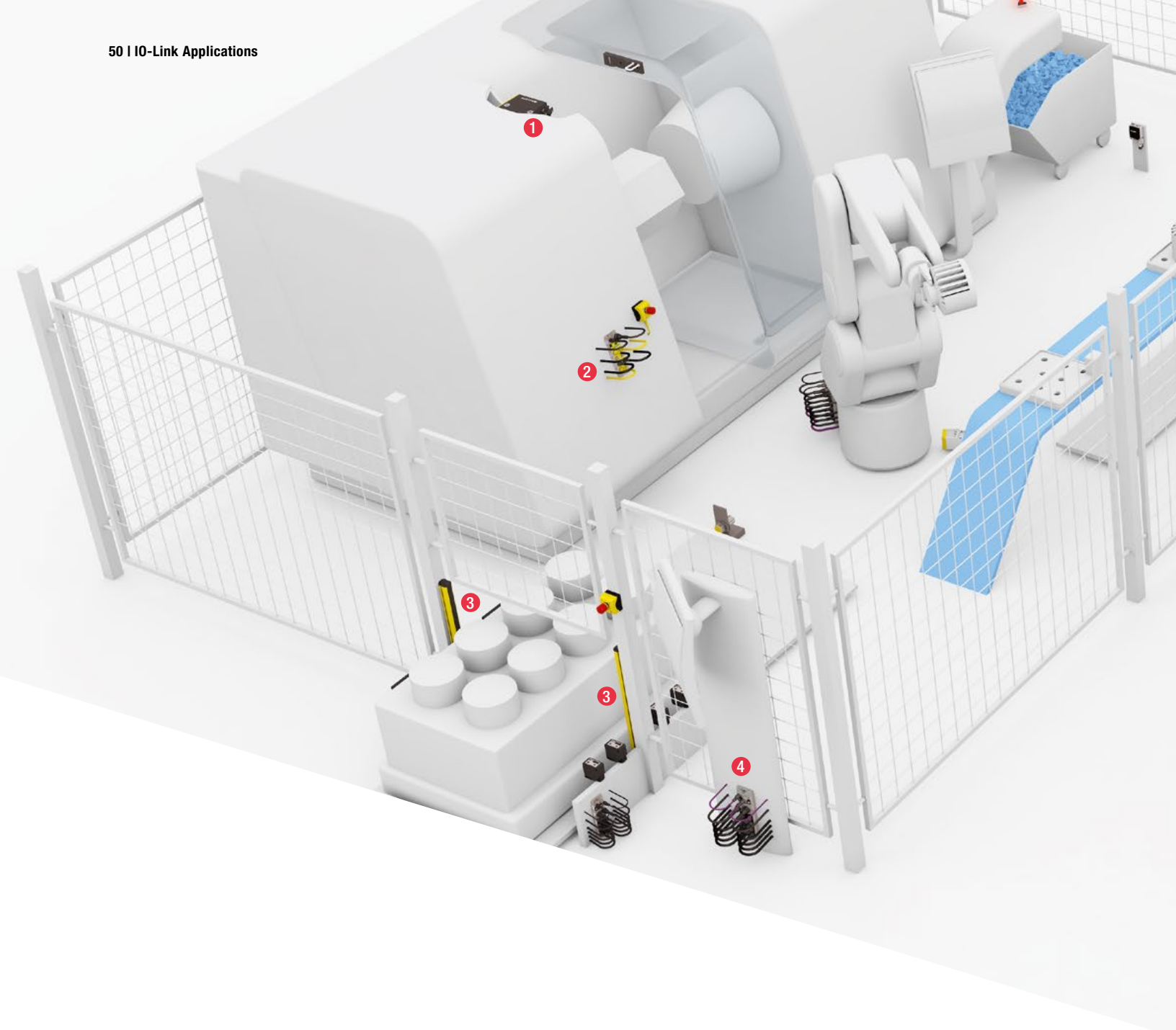

IO-Link supplies both sensor/actuator details and secure information

Robotics is indispensable to modern automation, but it demands safety in order to enable the fast interaction between man and machine. Safety technology is, thus, a given for automation; only with it can, for example, fast applications with pick-and-place be realized.

We offer solutions which will work precisely and safely over years. And the best part is that these are also quite easy to implement because safety technology from Balluff offers the advantages of IO-Link.

Safety with IO-Link is simple to integrate and reacts quickly. It communicates down to the last meter and provides both sensor/actuator details as well as safety information. This lets you realize reliable, flexible information exchange and data transport across all levels.

Integration is as simple as connecting the safe I/O module to the IO-Link master. You can connect nearly any safety device to this system, which is open all the way to the sensor level, and bundle the signals from binary standard sensors. The parameterization is done centrally via the controller. The safety-relevant information is sent through the master to the controller.

- 1 RFID interlocks
- 2 Safe IO-Link I/O modules
- 3 Opto-electronic protective devices
- 4 IO-Link masters
- 5 Transponder-coded safety sensors
- 6 Electromechanical safety switches

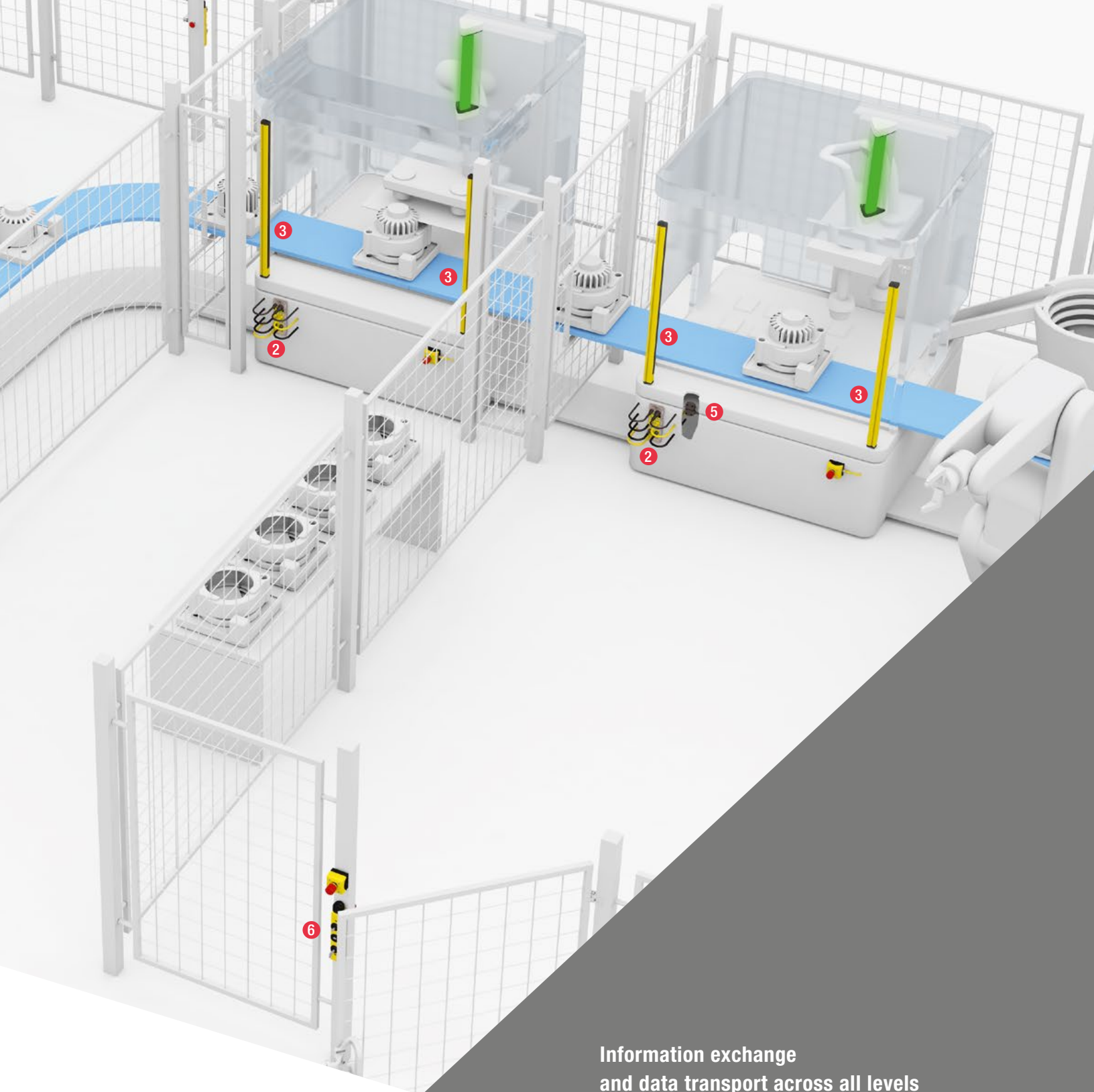

Information exchange
and data transport across all levels

Safety over IO-Link

For the fast interaction of man and machine

Safe personal protection

Economically securing hazardous locations

An economical solution for securing hazardous locations is our safety light curtains. These non-contact, protective devices reliably detect fingers, hands or the body and stop all hazard-inducing movements of machines. They ensure personal safety and eliminate the expense of guard fence constructions, so that you can better use the available space. Additionally, you profit from high anti-tamper protection. Simply connect the light grid to the safe I/O module that is connected to the IO-Link master. You have now produced the safety function and reduced costs because the connectivity is through the familiar M12 standard.

To be able to reliably feed material to the robot, our safety light curtains can also be used at material locks so that the muting applications can be implemented. There the safety function is temporarily jumped over when the material is transported through the protective field. Safety is, however, still maintained in case a person inadvertently attempts to enter the hazardous zone.

In the worst case, you can use our emergency stop device to trigger the stop command to halt the hazardous movement. Our emergency stop is simple to install and versatile in its use. Its compact housing makes it ideal for a wide range of machines and systems while its high protection rating means it is impervious to dust and water.

- 1 Opto-electronic protective devices
- 2 Safe IO-Link I/O modules
- 3 Emergency stop device
- 4 IO-Link SmartLight



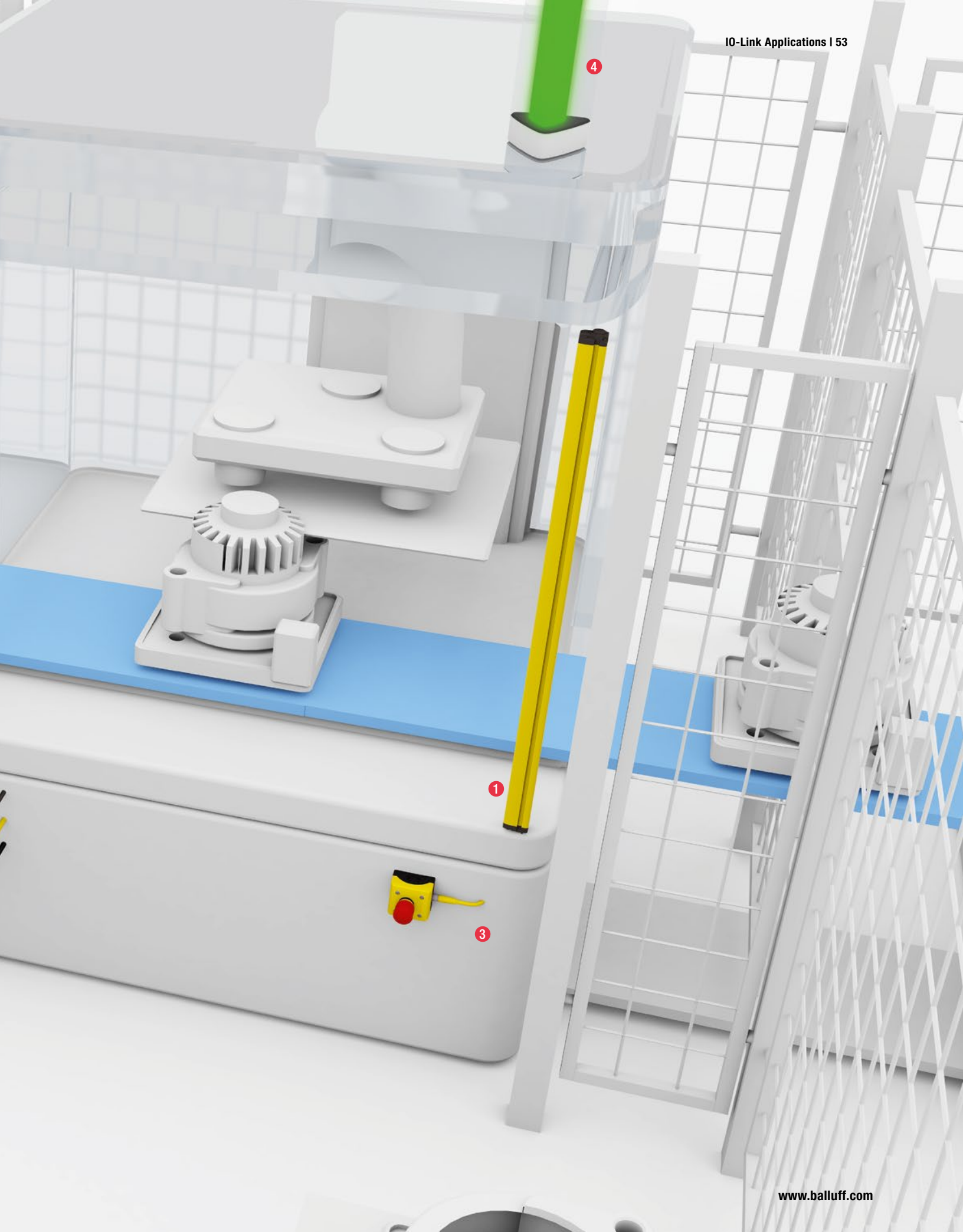

4

1

3

Wear-free and tamper-proof

Safety for people and systems

Direct querying of robot position and end-of-travel with metal

Our inductive safety sensors offer you safety for people and equipment. These detect the approach of metallic objects without contact and provide you with the needed safe signals for position or end-of-travel. Now you can safely monitor robots and workpiece carriers. Unlike traditional safety switches, inductive safety sensors require no special mating part, making it easy to directly query robot position and end-of-travel of metallic workpiece carriers. Simply connect the sensors to the safe I/O module, which bundles all the signals and passes them to the processor through the IO-Link master.

An economical solution to access security

Our REED safety switches ensure wear-free access security. This economical solution is insensitive to door shifting and highly rugged. Another plus: the spacer even makes it possible to install in ferromagnetic surroundings.

When there is strong vibration

To meet higher demands, transponder-coded safety sensors are indispensable. Our RFID safety sensors ensure safe monitoring of guard doors which are subjected to strong vibration. You enjoy the benefits of both high coding levels and high anti-tamper protection because the passive RFID transponders are uniquely identifiable.

The contamination-resistant sensors, with a generous detection range, are ideal when doors settle or are imprecisely guided. This also means they offer great room to play for installation. And to save on door fittings, you can choose versions with integrated magnetic clamps.

- 1 Inductive safety sensors
- 2 Emergency stop device
- 3 Safe IO-Link I/O modules

- 4 Transponder-coded safety sensors
- 5 Electromechanical safety switches
- 6 Opto-electronic protective devices



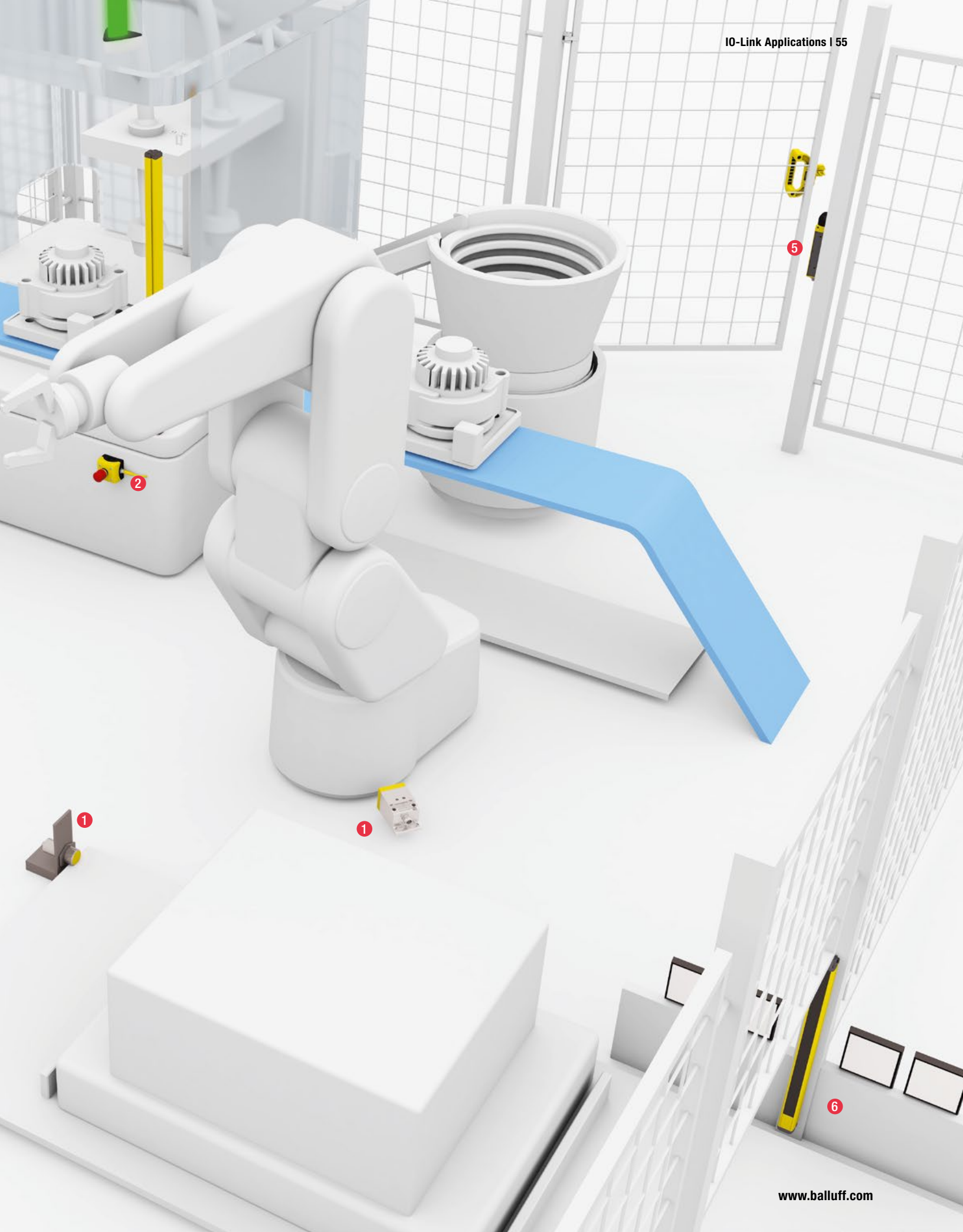

For pneumatics and hydraulics

Safety for clamping equipment

All-in-one solution for connecting galvanically isolated sensors and actuators

Our galvanically isolated sensor/actuator hub ensures safety on the workpiece holder. This all-in-one solution allows you to connect both sensors and actuators to just one module. The sensor segment provides the position feedback. At the same time, you can safely turn off the actuator segment using its separately switchable safety circuit, since the IO-Link I/O hub is divided into two galvanically isolated segments.

To safely interrupt the supply voltage to the actuator segment, you need an external safety device to implement safety functions up to SIL2, in accordance with EN62061. The rugged IP67 metal housing is designed even for the harshest surroundings. Diagnostics are provided by IO-Link and status LEDs and can also reliably monitor the signal quality.

Up to eight digital inputs and outputs can be controlled with the module. If the IO-Link connection is interrupted, the outputs assume predefined states which remain until the IO-Link connection is restored. Because of this clear machine status, you can continue to produce without a reference move and save valuable time once the connection is made again.

- 1 Magnetic field sensors
- 2 IO-Link master
- 3 IO-Link I/O module with galvanic isolation
- 4 Emergency stop device





1

3

4

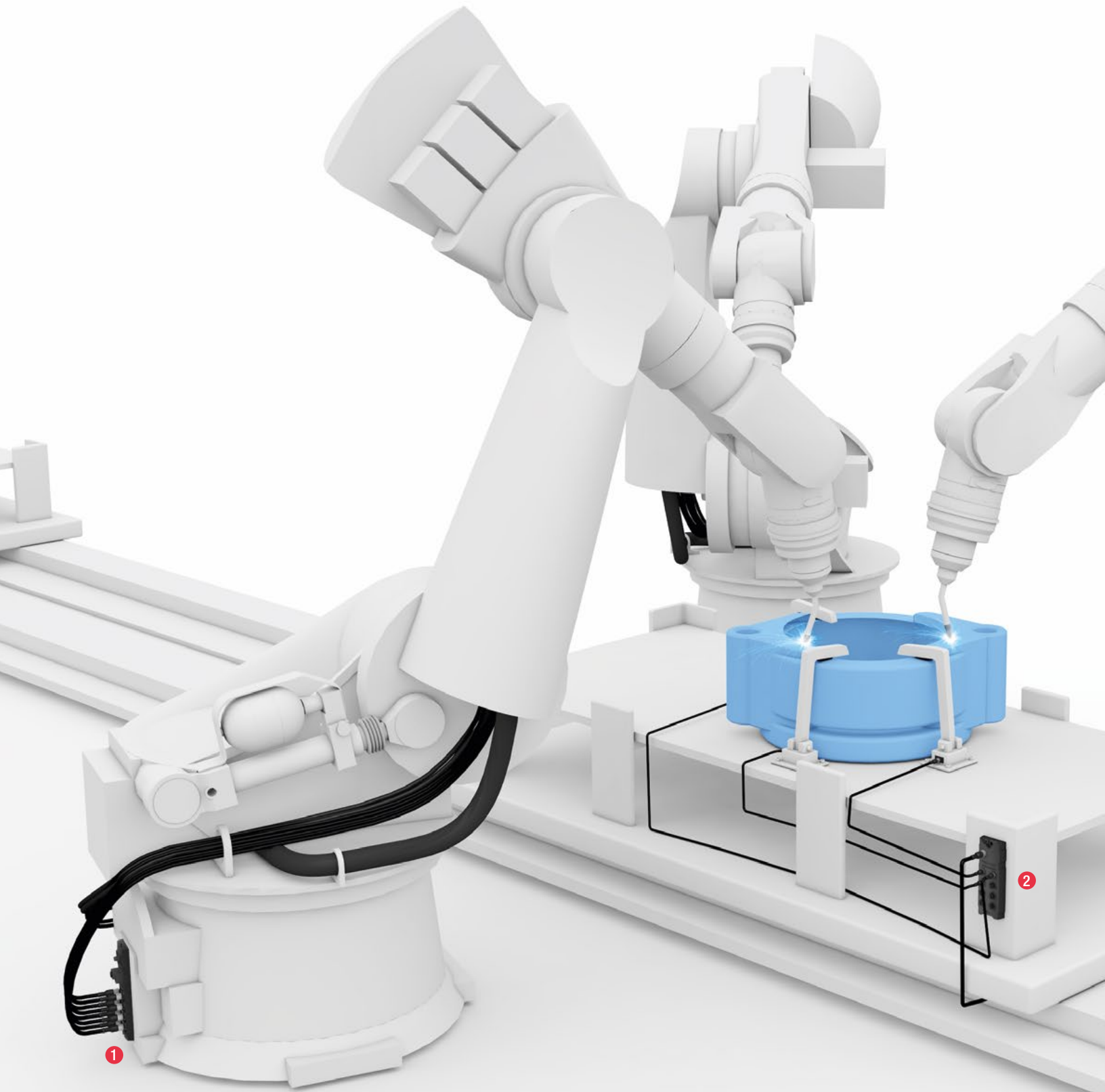



For the extreme conditions of welding

Reliably transmit signals in electrical noise fields

Decentralized system architecture in the welding booth

For the extreme conditions of welding, Balluff offers rugged modules for reliable signal transmission even in the presence of interfering ambient influences. Our weld-immune modules, made of fiberglass-reinforced plastic, can reliably handle weld spatter, welding currents and electromagnetic fields.

The easy to install modules are available as IO-Link masters and IO-Link sensor/actuator hubs, each with 8 IO-Link ports for 16 inputs and outputs. Each input is short-circuit proof while each output is protected from overload. In addition, our IO-Link sensor/actuator hubs offer an expansion port for connecting an IO-Link valve interface or another IO-Link sensor/actuator hub, allowing you to use up to 30 inputs and outputs. This lets you flexibly integrate innovative fieldbus solutions.

The efficient point-to-point wiring of IO-Link allows construction of a decentralized system architecture in the welding booth outside the control cabinet. Network nodes equipped with an IO-Link master communicate via Ethernet/IP directly with the main controller or control device on the machine.

You can connect a wide variety of intelligent sensors or I/O modules with IO-Link interface to the IO-Link ports. These simple structures are highly flexible and the parameters are also simple to transmit. Continuous diagnostics ensure reliable monitoring and the affordable, three-core, unshielded industrial cables reduce wiring time.

- 1 IO-Link masters (weld-immune)
- 2 IO-Link sensor/actuator hubs (weld-immune)

The optimal power supply for condition monitoring

For noise-free operation

Our IO-Link Heartbeat power supplies, used to deliver reliable and efficient voltage, stand out thanks to their quality and long service life. They are manufactured from the highest quality components and offer you adjustable output voltage with low ripple.

Especially notable is their clever diagnostics capability which supports predictive maintenance and condition monitoring for Industry 4.0 requirements.

Integrated monitoring provides information for load level, stress level and lifetime via IO-Link. This gives you reliable information about the current electrical and thermal load, the degree of wear and the remaining lifetime of the power supply. You can also find this information locally on the status indicator using the 3-color LEDs that work like a traffic light.

You can use IO-Link to call up further detailed diagnostics and status information for the unit as well as operating parameters and history. This allows you to see the data in the higher level control and diagnostics system. You increase system up-time by knowing at all times when you need to replace a unit.

Specially developed for controller units, Balluff power supplies can be perfectly integrated into your control package. The extra narrow IP20 housing enables a resource-optimized control cabinet design. IP67 variants are also available for supplying power to the modules in decentralized structures in direct proximity to the consumer.

- 1 Heartbeat power supplies with IO-Link IP20
- 2 Heartbeat power supplies with IO-Link IP67



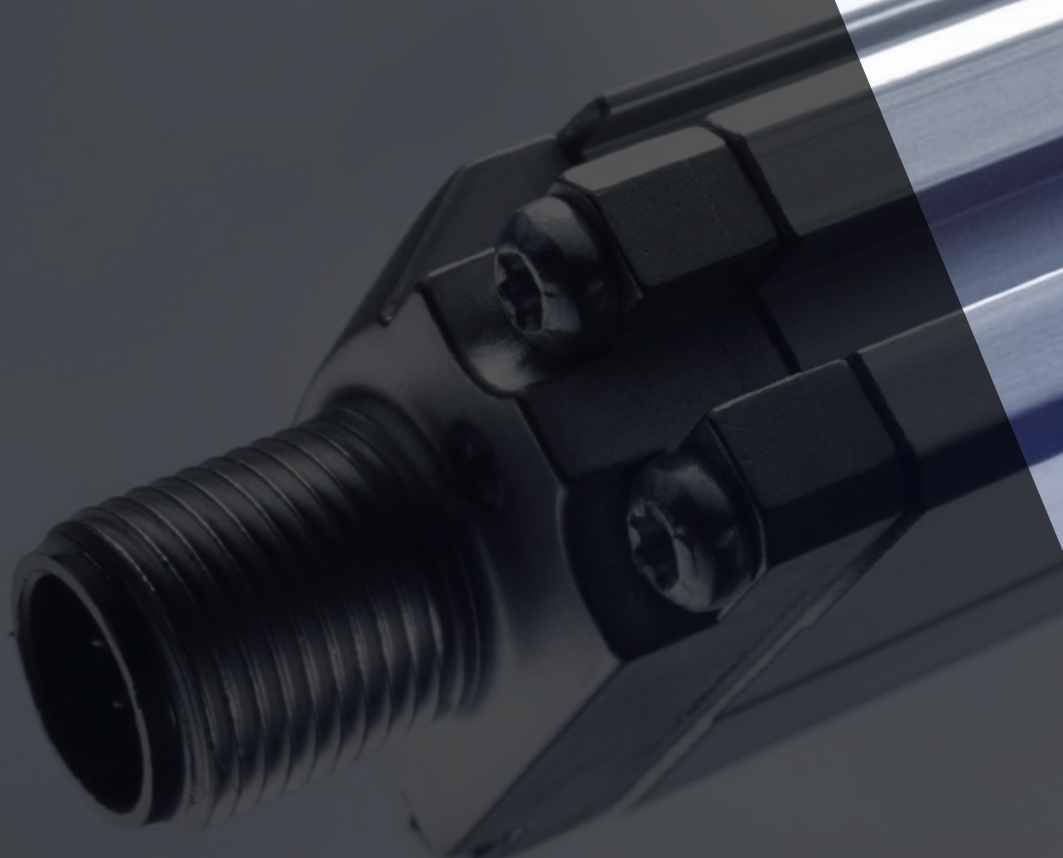

Comprehensive solutions for food and beverage industry

SENSORS.

 *innovating automation*

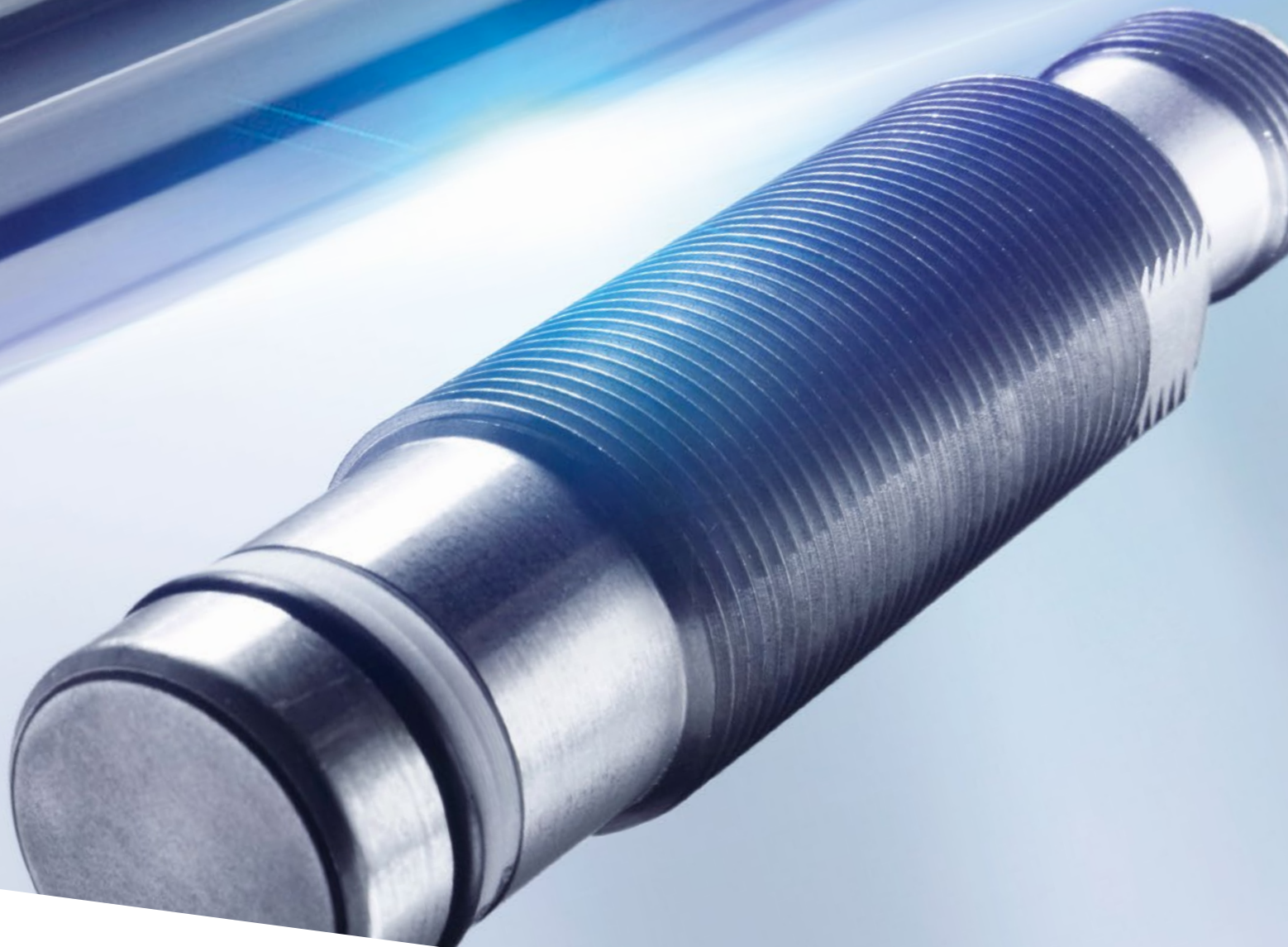

In the field of sensor technology, Balluff handles the entire range of technological diversity with its various operating principles. We provide you with high-quality sensors for any application or requirement – distance measurement to object detection and level, temperature and pressure monitoring. For everyday industrial uses as well as for tough applications in critical environments, Balluff's solution expertise in automation is truly comprehensive.

Our quality management regime is DIN EN ISO 9001:2008 certified. All Balluff sensors are tested in our in-house, accredited laboratory. Balluff sensors meet regional as well as international standards and are used throughout the world.

Your Balluff solutions

- Inductive sensors
- Photoelectric sensors
- Capacitive sensors
- Magnetic field sensors
- Ultrasonic sensors
- Mechanical switches
- Magnetostrictive sensors
- Magnetic encoders
- Pressure sensors
- Temperature sensor



STANDARD INDUCTIVE SENSORS

	BES04FK BES M12MI-PSIC20C-S04G		
Dimension	Ø 12 x 65 mm		
Style	M12x1		
Installation	for flush mounting		
Range	0.5...2 mm		
Interface	IO-Link 1.1		
Switching output	PNP Normally open		
Switching frequency	2000 Hz		
Repeat accuracy	5.0 % FS		
Housing material	Brass		
Surface protection	Nickel-free coated		
Material sensing surface	LCP		
Connection	Connector, M12x1-Male, 4-pole		
Operating voltage U_b	12...30 VDC		
Ambient temperature	-25...85 °C		
IP rating	IP68		
Approval/conformity	cULus, CE, EAC		
Process data	Switch point, Target uncertainty		

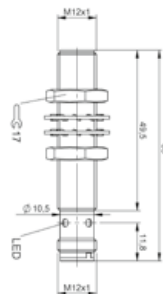

Housing material definitions:
LCP Liquid Crystalline Polymer



INDUCTIVE DISTANCE SENSORS

	BAW004M BAW M12MI-BLC35C-S04G	BAW0056 BAW M12MH-BLC70G-S04G	BAW002F BAW M18MI-BLC50B-S04G	
Dimension	Ø 12 x 65 mm	Ø 12 x 65 mm	Ø 18 x 65 mm	
Style	M12x1	M12x1	M18x1	
Installation	for flush mounting	non-flush	for flush mounting	
Range	0.2...3.5 mm	0.2...7 mm	1...5 mm	
Interface	IO-Link 1.1	IO-Link 1.1	IO-Link 1.0	
Analog output	falling on approach	falling on approach	falling on approach	
Repeat accuracy	0.2 % FS	0.2 % FS	3.0 % FS	
Non-linearity max.	±35 µm	±70 µm	±120 µm	
Housing material	Brass	Brass	Brass	
Surface protection	Nickel-free coated	Nickel-free coated	nickel plates	
Material sensing surface	PBT	LCP	PBT	
Connection	Connector, M12x1-Male, 4-pole	Connector, M12x1-Male, 4-pole	Connector, M12x1-Male, 4-pole	
Operating voltage U_b	18...30 VDC	18...30 VDC	18...30 VDC	
Ambient temperature	-40...80 °C	-25...70 °C	-10...70 °C	
IP rating	IP67	IP67	IP67	
Approval/conformity	CE, cULus, EAC	CE, cULus, EAC	CE, cULus, EAC	
Process data	Position value 3x Switch points Out of range	Position value 3x Switch points Out of range	Position value	

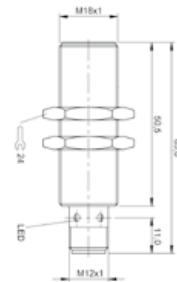
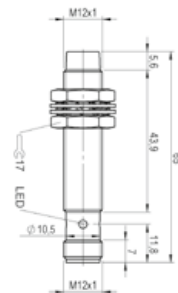
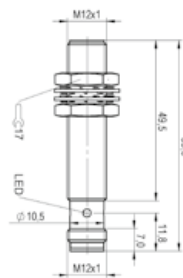

Housing material definitions:
 LCP Liquid Crystalline Polymer
 PBT Polybuteneterephthalate



BAW003A BAW Z01AC-BLD50B-DP03	BAW003W BAW Z05AC-BLD50B-BP00,75-GS04			
38.5 x 14 x 17 mm	30 x 38.5 x 16.5 mm			
block style	block style			
non-flush	non-flush			
1...5 mm	1...5 mm			
IO-Link 1.0	IO-Link 1.0			
falling on approach	falling on approach			
1.0 % FS	1.0 % FS			
±150 µm	±150 µm			
Aluminum	Aluminum			
Anodized	Anodized			
LCP	LCP			
Cable, 3.00 m, PUR	Cable with connector, M12x1-Male, 4-pole, 0.75 m, PUR			
18...30 VDC	18...30 VDC			
-10...60 °C	-10...60 °C			
IP67	IP67			
CE, cULus, EAC	CE, cULus, EAC			
Position value 3x Switch points Error code	Position value 3x Switch points Error code			

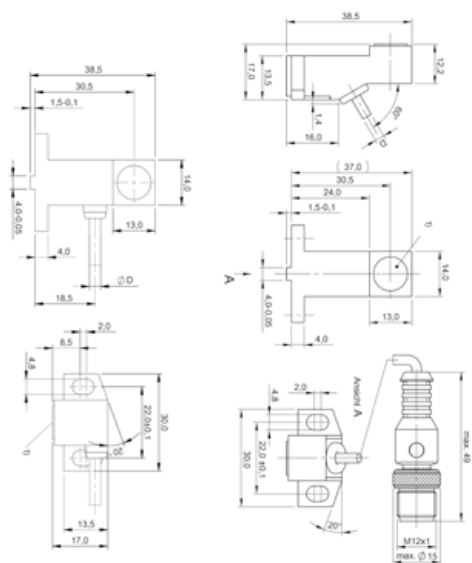

INDUCTIVE LINEAR POSITIONING SENSORS



	BIP000F BIP LD2-T014-01-EP01-S4	BIP0007 BIP LD2-T014-01-EP02	BIP001M BIP LD2-T017-04-BP00,5-S4	
Dimension	35 x 35 x 31 mm	35 x 35 x 31 mm	30 x 18 x 40.5 mm	
Style	block style	block style	block style	
Connection	Cable with connector, M12x1-Male, 4-pole, 1.00 m, PUR	Cable, 2.00 m, PUR	Cable with connector, M12x1-Male, 3-pole, 0.5 m, PUR	
Housing material	PA	PA	PA	
Measuring range	0...14 mm	0...14 mm	0...17 mm	
Installation	non-flush	non-flush	flush	
Interface	IO-Link 1.0	IO-Link 1.0	IO-Link 1.1	
Repeat accuracy per BWN	±80.0 µm	±80.0 µm	±40 µm	
Non-linearity max.	±250 µm	±250 µm	±250 µm	
Operating voltage Ub	18...30 VDC	18...30 VDC	18...30 VDC	
Ambient temperature	-25...70 °C	-25...70 °C	-25...70 °C	
IP rating	IP67	IP67	IP67	
Approval/conformity	CE, IO-Link, EAC, UR	CE, UR, EAC	CE, cURus, EAC	
Process data	Position value Out of range	Position value Out of range	Position value 3 x Switch points Out of range	

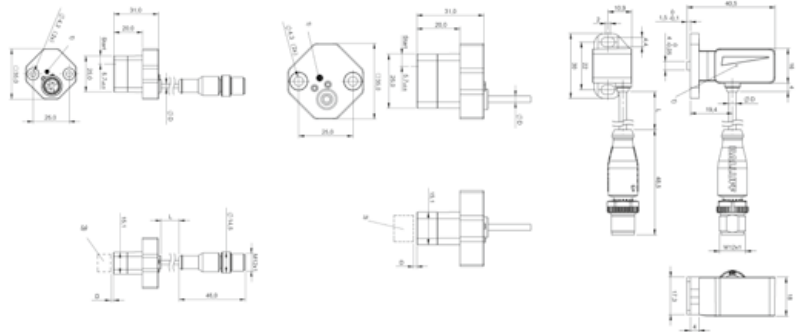

Housing material definitions:
PA Polyamide



BIP0004 BIP LD2-T040-02-S4				
70 x 30 x 31 mm				
block style				
Connector, M12x1-Male, 4-pole				
PA				
0...40 mm				
flush				
IO-Link 1.0				
±100.0 µm				
±500 µm				
18...30 VDC				
-25...85 °C				
IP67				
CE, UR, EAC				
Position value Out of range				

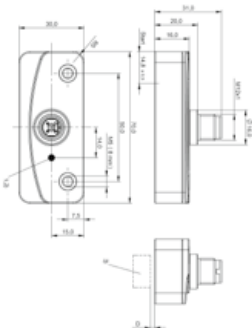

PHOTOELECTRIC
THROUGH-BEAM SENSORS

	BOS023H BOS 18E-PI-RE30-S4	BOS023J BOS 18E-XI-RS30-S4	BOS01UC BOS 18M-PI-RE30-S4	
Series	18E	18E	18M	
Dimension	Ø 18 x 75 mm	Ø 18 x 75 mm	Ø 18 x 75 mm	
Interface	IO-Link 1.1 PNP NO/NC	IO-Link 1.1	IO-Link 1.1 PNP NO/NC	
Principle of operation	Photoelectric Sensor	Photoelectric Sensor	Photoelectric Sensor	
Principle of optical operation	Through-beam sensor (Receiver)	Through-beam sensor (Emitter)	Through-beam sensor (Receiver)	
Beam characteristic				
Light type	Red light	Red light	LED, red light	
Light spot size				
Range	0...20 m	0...20 m	0...20 m	
Connection	Connector, M12x1-Male, 4-pole	Connector, M12x1-Male, 4-pole	Connector, M12x1-Male, 4-pole	
Housing material	Stainless steel (1.4571), Glass	Stainless steel (1.4571), Glass	Brass, Glass	
Operating voltage U_b	18...30 VDC	18...30 VDC	18...30 VDC	
Approval/conformity	cULus, CE, EAC	cULus, CE, EAC	cULus, CE, EAC	
Process data	1x Switch point uncertainty	Emitter defect	1x Switch point uncertainty	

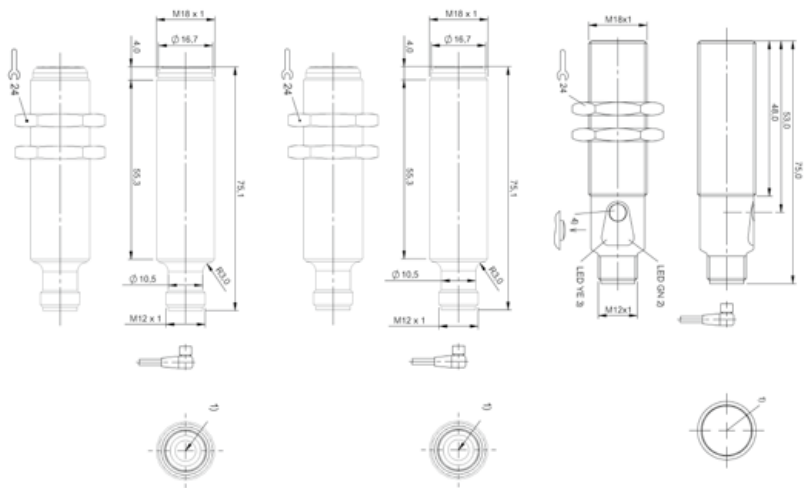

Housing material definitions:
 ABS Acrylonitrile Butadiene Styrene
 PC Polycarbonate



BOS01UF BOS 18M-XI-RS30-S4	BOS016J BOS 23K-GI-RE10-S4	BOS01UT BOS 23K-XI-RS11-S4		
18M	23K	23K		
∅ 18 x 75 mm	23 x 51 x 52.4 mm	23 x 51 x 52.4 mm		
IO-Link 1.1	PNP/NPN NO/NC IO-Link 1.1	IO-Link		
Photoelectric Sensor	Photoelectric Sensor	Photoelectric Sensor		
Through-beam sensor (Emitter)	Through-beam sensor (Receiver)	Through-beam sensor (Emitter)		
		Divergent		
LED, red light	LED, red light	LED, red light		
		600 x 600 mm at 20 m		
0...20 m	0...20 m	0...20 m		
Connector, M12x1-Male, 4-pole	Connector, M12x1-Male, 4-pole	Connector, M12x1-Male, 4-pole		
Brass	PC ABS	PC ABS		
18...30 VDC	18...30 VDC	18...30 VDC		
cULus, CE, EAC	Ecolab, CE, cULus, EAC	CE, cULus, Ecolab, EAC		
Emitter defect	2x Switch point Light intensity value	Transmitter on/off status		

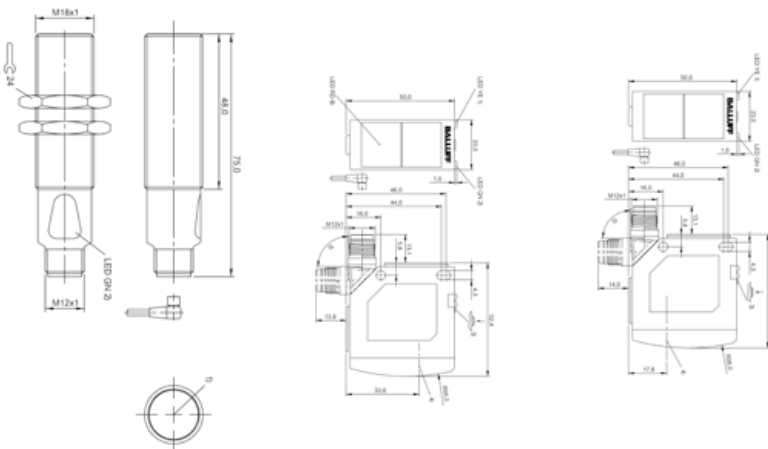

PHOTOELECTRIC DIFFUSE SENSORS



	BOS023E BOS 18E-PI-RD30-S4	BOS01UA BOS 18M-PI-RD30-S4	BOS0171 BOS 23K-GI-RD10-S4
Series	18E	18M	23K
Dimension	Ø 18 x 75 mm	Ø 18 x 75 mm	23 x 51 x 52.4 mm
Interface	IO-Link 1.1 PNP NO/NC	IO-Link 1.1 PNP NO/NC	IO-Link PNP/NPN NO/NC
Principle of operation	Photoelectric Sensor	Photoelectric Sensor	Photoelectric Sensor
Principle of optical operation	Diffuse sensor, (energetic)	Diffuse sensor, (energetic)	Diffuse sensor, (energetic)
Beam characteristic	Divergent	Divergent	Focus, typical at 600 mm
Light type	Red light	LED, red light	LED, red light
Light spot size			14 x 14 mm at 600 mm
Range	1...500 mm	1...500 mm	0...2000 mm
Connection	Connector, M12x1-Male, 4-pole	Connector, M12x1-Male, 4-pole	Connector, M12x1-Male, 4-pole
Housing material	Stainless steel (1.4571)	Brass	PC ABS
Operating voltage U_b	18...30 VDC	18...30 VDC	18...30 VDC
Approval/conformity	cULus, CE, EAC	cULus, CE, EAC	CE, Ecolab, cULus, EAC
Process data	Switch point, Emitter defect, Uncertainty	Switch point, Emitter defect, Uncertainty	2x Switch point, Light intensity value

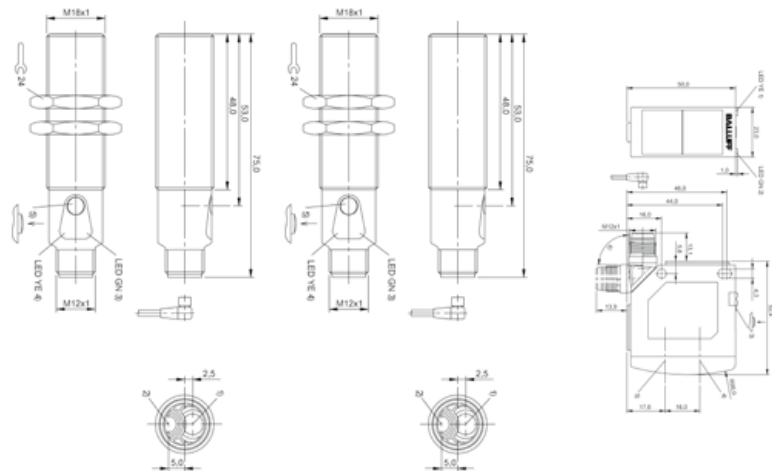

Housing material definitions:
 ABS Acrylonitrile Butadiene Styrene
 PC Polycarbonate



BOS01JJ BOS 50K-PI-RD11-S4				
50K				
28.5 x 80.5 x 62 mm				
IO-Link 1.1 PNP NO/NC				
Photoelectric Sensor				
Diffuse sensor, (energetic)				
Divergent				
LED, red light				
80 x 80 mm at Sr				
1...3500 mm				
Connector, M12x1-Male, 4-pole				
PC ABS				
10...30 VDC				
CE, cULus, EAC				
2x Switch point, Light intensity value				

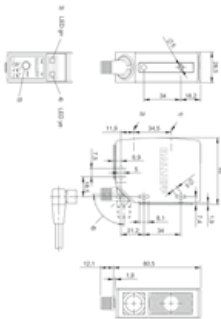

PHOTOELECTRIC DIFFUSE SENSORS WITH BACKGROUND SUPPRESSION



	BOS0246 BOS 08E-PI-KH22-00,2-S49	BOS0247 BOS 08E-PI-KH22-S49	BOS017A BOS 23K-GI-RH10-S4
Series	08E	08E	23K
Dimension	∅ 8 x 40 mm	∅ 8 x 40 mm	23 x 51 x 52.4 mm
Interface	PNP Normally open (NO) IO-Link 1.1	PNP Normally open (NO) IO-Link 1.1	IO-Link PNP/NPN NO/NC
Principle of operation	Photoelectric Sensor	Photoelectric Sensor	Photoelectric Sensor
Principle of optical operation	Diffuse sensor, Triangulation	Diffuse sensor, Triangulation	Diffuse sensor, Triangulation
Special optical feature	Background suppression	Background suppression	Background suppression
Beam characteristic	Divergent	Divergent	Focus, typical at 500 mm
Light type	LED, red light	LED, red light	LED, red light
Light spot size	∅ 2.5 mm Light exit	∅ 2.5 mm Light exit	15 x 15 mm at focal point
Range	30 mm	30 mm	1.2 m
Connection	Cable with connector, M8x1-Male, 3-pole, 0.20 m, PUR	Connector, M8x1-Male, 3-pole	Connector, M12x1-Male, 4-pole
Housing material	Stainless steel	Stainless steel	PC ABS
Operating voltage U_b	10...30 VDC	10...30 VDC	18...30 VDC
Approval/conformity	cULus, CE, IO-Link, EAC	CE, cULus, IO-Link, EAC	CE, Ecolab, cULus, EAC
Process data	Switch point, Uncertainty	Switch point, Uncertainty	2x Switch point, Stability indicator

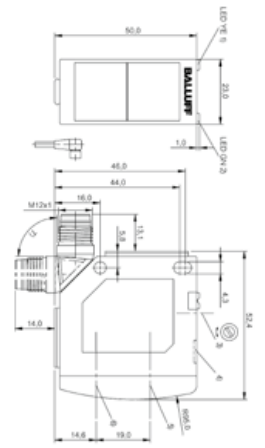
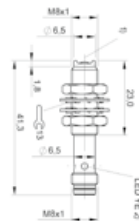
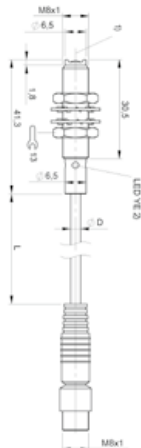

Housing material definitions:
 ABS Acrylonitrile Butadiene Styrene
 PC Polycarbonate

PHOTOELECTRIC RETROREFLECTIVE SENSORS



	BOS023F BOS 18E-PI-PR30-S4	BOS01UE BOS 18M-PI-PR30-S4	BOS016T BOS 23K-GI-RR10-S4
Series	18E	18M	23K
Dimension	Ø 18 x 75 mm	Ø 18 x 75 mm	23 x 51 x 52.4 mm
Interface	IO-Link 1.1 PNP NO/NC	IO-Link 1.1 PNP NO/NC	IO-Link PNP/NPN NO/NC
Principle of operation	Photoelectric Sensor	Photoelectric Sensor	Photoelectric Sensor
Principle of optical operation	Retroreflective sensor	Retroreflective sensor	Retroreflective sensor
Beam characteristic	Divergent	Divergent	Divergent
Light type	Red light	LED, red light	LED, red light
Light spot size			300 x 300 mm at 12 m
Range	0...5 m	0...5 m	0...12 m
Connection	Connector, M12x1-Male, 4-pole	Connector, M12x1-Male, 4-pole	Connector, M12x1-Male, 4-pole
Housing material	Stainless steel (1.4571)	Brass	PC ABS
Operating voltage U_b	18...30 VDC	18...30 VDC	18...30 VDC
Approval/conformity	cULus, CE	CE, cULus, EAC	Ecolab, CE, cULus
Process data	Switch point, Emitter defect, uncertainty	Switch point, Emitter defect, uncertainty	2x Switch point, Light intensity value

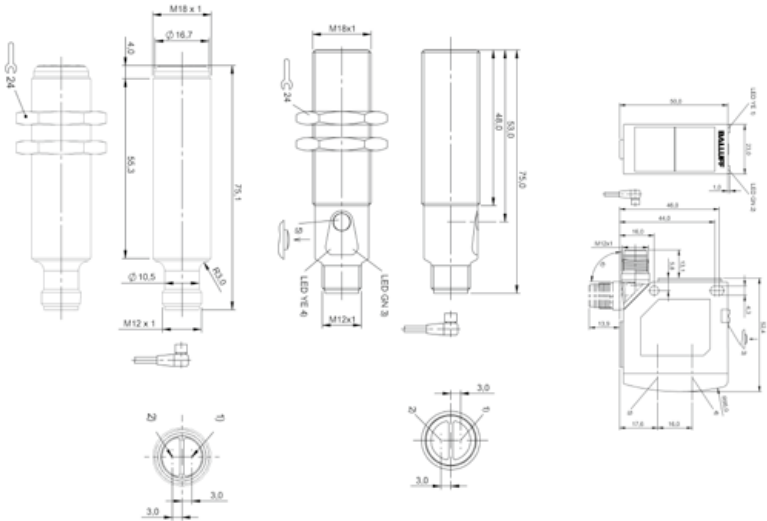

Housing material definitions:
ABS Acrylonitrile Butadiene Styrene
PC Polycarbonate



PHOTOELECTRIC DISTANCE SENSORS

	BOD0020 BOD 23K-LI01-S4	BOD0023 BOD 24K-LI04-S92	BOD0026 BOD 24K-LI05-S92	
Series	23K	24K	24K	
Dimension	51 x 23 x 52.4 mm	50 x 21 x 50 mm	50 x 21 x 50 mm	
Interface	PNP/NPN/Auto-Detect NO/NC IO-Link 1.1	IO-Link 1.1	IO-Link 1.1	
Principle of operation	Photoelectric Distance Sensor BOD	Photoelectric Distance Sensor BOD	Photoelectric Distance Sensor BOD	
Principle of optical operation	Light time-of-flight	Triangulation	Triangulation	
Beam characteristic				
Light type	Laser red light	Laser red light	Laser red light	
Light spot size	5.5 x 7 mm at 5 m	1 x 1 mm at 100 mm	1 x 1 mm at 450 mm	
Range	100...5000 mm	50...100 mm	50...650 mm	
Repeat accuracy	0.024 % FS	0.25 % FS	0.5 % FS	
Resolution	≤ 5 mm	≤ 10 μm	≤ 500 μm	
Connection	Connector, M12x1-Male, 4-pole	Connector, M12x1-Male, 5-pole	Connector, M12x1-Male, 5-pole	
Housing material	ABS	Plastic	Plastic	
Operating voltage U _b	18...30 VDC	18...30 VDC	18...30 VDC	
Approval/conformity	CE, cULus, Ecolab	CE, CDRH, EAC	CE, CDRH, EAC	
Trademark	2x Switch point, Distance value, Signal quality	Distance value, Signal quality	Distance value, Signal quality	

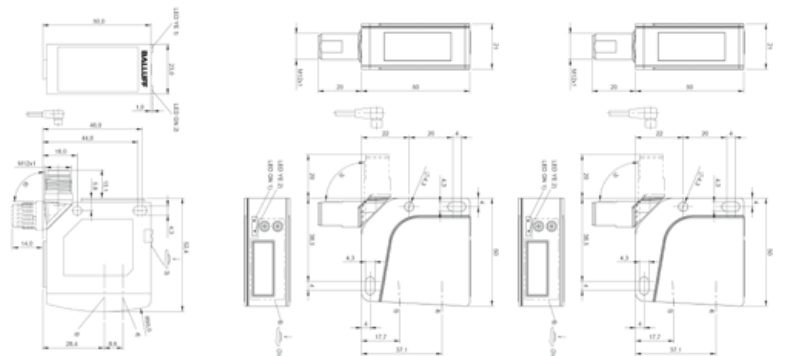

Housing material definitions:
 ABS Acrylonitrile Butadiene Styrene



BOD0012 BOD 63M-LI06-S4				
63M				
35 x 70 x 90 mm				
2x PNP Normally open (NO) IO-Link 1.0				
Photoelectric Distance Sensor BOD				
Light time-of-flight				
Collimated				
Laser red light				
Ø 10 mm at 6 m				
200...6000 mm				
0.067 % FS				
≤ 1.0 mm				
Connector, M12x1-Male, 4-pole				
Die-cast aluminum				
18...30 VDC				
CE, cULus, EAC				
Distance value, 4x Switch point, Error, Laser on/off control, Button on/off control				

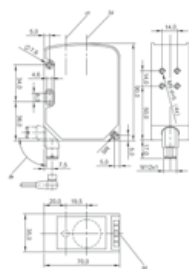



PHOTOELECTRIC FORK SENSORS

	BGL0035 BGL 30C-007-S4	BGL003F BGL 50C-007-S4	
Series	C	C	
Dimension	18 x 80 x 93.5 mm	18 x 100 x 93.5 mm	
Fork opening	30 mm	50 mm	
Interface	IO-Link NO/NC	IO-Link NO/NC	
Principle of operation	Fork sensor	Fork sensor	
Principle of optical operation	Through-beam sensor	Through-beam sensor	
Special optical feature	Light array	Light array	
Beam characteristic	Divergent	Divergent	
Light type	LED, red light	LED, red light	
Light spot size	3 x 28 mm Light exit	3 x 28 mm Light exit	
Connection	Connector, M12x1-Male, 4-pole	Connector, M12x1-Male, 4-pole	
Housing material	Aluminum	Aluminum	
Operating voltage U_b	18...30 VDC	18...30 VDC	
Approval/conformity	CE	CE	
Process data	Position value, 4x Switching points, Emitter error, Contamination warning	Position value, 4x Switching points, Emitter error, Contamination warning	

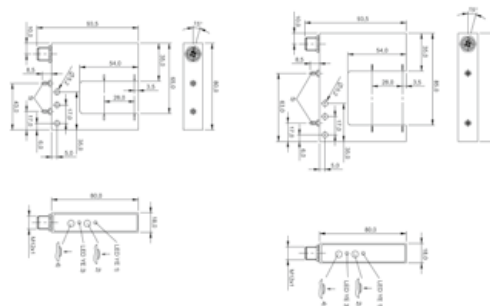

PHOTOELECTRIC COLOR SENSORS



	BFS000M BFS 33M-GSI-F01-S75	BFS000F BFS 26K-GI-L04-S92	
Series	33M	26K	
Dimension	21 x 58.3 x 58 mm	17 x 50 x 50 mm	
Interface	2x NO/NC IO-Link 1.1	PNP/NPN NO/NC IO-Link 1.0	
Principle of operation	Color sensor	Color sensor	
Principle of optical operation	Diffuse sensor, Amplifier	Diffuse sensor, Fixed focus	
Beam characteristic	Depends on fiber	Focused	
Light type	White light	White light	
Light spot size	Various lens available	Ø 4 mm at 22 mm	
Range	Depends on fiber	12...32 mm	
Connection	Connector, M8x1-Male, 4-pole	Connector, M12x1-Male	
Housing material	Aluminum	ABS	
Operating voltage Ub	21.6...26.4 VDC	18...30 VDC	
Approval/conformity	CE	CE, EAC	
Process data	255x Color switch points, Error codes	5x Color switch points	

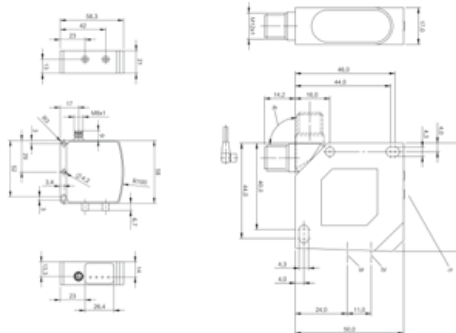

Housing material definitions:
 ABS Acrylonitrile Butadiene Styrene



PHOTOELECTRIC
LIGHT BAND SENSORS

	BLA0003 BLA 50A-002-S4		
Series	A		
Dimension	100 x 26 x 113 mm		
Interface	IO-Link 1.1		
Principle of operation	Light array		
Special optical feature	CCD technology		
Beam characteristic	Collimated light strip, width 54 mm		
Light type	Laser red light		
Light spot size	60 mm		
Range	0...2 m		
Connection 1	M12x1-Male, 4-pole		
Connection 2	M12x1-Female, 4-pole		
Connection 3	M12x1-Male, 4-pole		
Housing material	Aluminum		
Operating voltage U_b	18...30 VDC		
Approval/conformity	CE		
Process data	2x Measurement values (mm) 6x Switching points Count value		

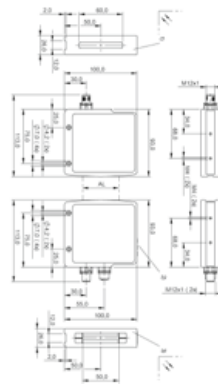



PHOTOELECTRIC
LIGHT SWITCH AND BARRIER SENSORS

	BOS026R BOS 21M-UUI-RP30-S4	
Series	21M	
Dimension	15 x 51 x 42.5 mm	
Interface	2x PNP/NPN/Push-pull, NO/NC, IO-Link 1.1	
Principle of operation	Photoelectric Sensor	
Principle of optical operation	Diffuse sensor, Diffuse sensor with background suppression, Retroreflective sensor, Through-beam sensor (Emitter), Through-beam sensor (receiver) depending on setting	
Special optical feature	Multi-functional	
Beam characteristic	Divergent	
Light type	LED, red light	
Light spot size	Ø 50 mm at 1 m	
Range	Diffuse sensor with background suppression 8...200 mm, Diffuse sensor 1...600 mm, Retroreflective sensor 0...7 m, Through-beam sensor 0...10 m	
Connection	Connector, M12x1-Male, 4-pole	
Housing material	Die-cast zinc, Aluminum, Glass, PC	
Operating voltage U_b	10...30 VDC	
Approval/conformity	CE; EAC	
Process data	1x Switch point, Stability, Count Value, Count Status, Emitter on/off	

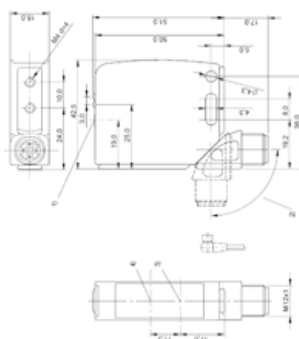

Housing material definitions:
PC Polycarbonate

CAPACITIVE LEVEL SENSOR
WITH CONTACT

	BCS011E BCS S04K501-PICFNG-S04G-T50	BCS011L BCS S04K501-PICFNG-S04G-T51	
Dimension	Ø 30 x 96 mm	Ø 30 x 96 mm	
Connection	Connector, M12x1-Male, 4-pole	Connector, M12x1-Male, 4-pole	
Switching output	PNP Normally open (NO)	PNP Normally open (NO)	
Switching frequency	5 Hz	5 Hz	
Interface	IO-Link 1.1	IO-Link 1.1	
Range	basic	oil-based media	
Sensitivity	teachable depending on media	teachable depending on media	
Installation	non-flush	non-flush	
Housing material	Stainless steel (1.4404)	Stainless steel (1.4404)	
Ambient temperature	-40...85 °C	-10...85 °C	
Operating voltage U_b	18...30 VDC	18...30 VDC	
Approval/conformity	CE, FDA compliant, EHEDG conformal, IO-Link	IO-Link, EHEDG conformal, FDA compliant, CE	
IP rating	IP68	IP68	
Process data	Switch Point Sensor Value 0...4095	Switch Point Sensor Value 0...4095	

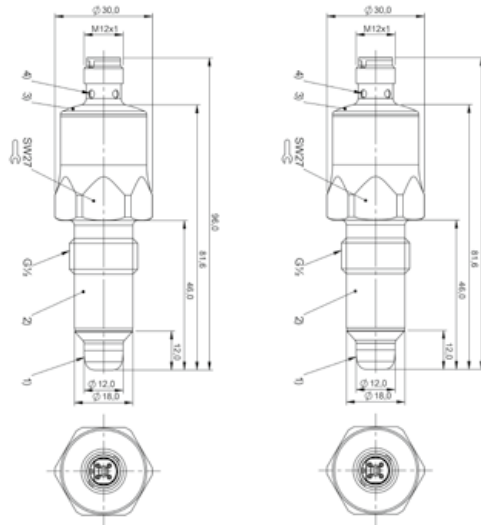

CAPACITIVE LEVEL SENSOR
WITHOUT CONTACT



	BCS012P BCS R08RRE-PIMFHC-EP00,3-GS04		
Dimension	34 x 16 x 8 mm		
Connection	Cable with connector, M12x1-Male, 4-pole, 0.30 m, PUR		
Switching output	PNP Normally open (NO)		
Switching frequency	10 Hz		
Interface	IO-Link 1.1		
Range	Smart Level		
Sensitivity	teachable depending on media		
Installation	flush with container outer wall		
Housing material	PP		
Ambient temperature	-25...70 °C		
Operating voltage Ub	18...30 VDC		
Approval/conformity	UL Listed, IO-Link, CE		
IP rating	IP67		
Process data	Switch Point Sensor Value 0...4095		



Housing material definitions:
PP Polypropylene

CAPACITIVE SENSOR
FOR OBJECT DETECTION



	BCS012N BCS R08RRE-PIM80C-EP00,3-GS04		
Dimension	34 x 16 x 8 mm		
Connection	Cable with connector, M12x1-Male, 4-pole, 0.30 m, PUR		
Switching output	PNP Normally open (NO)		
Switching frequency	50 Hz		
Interface	IO-Link 1.1		
Range	1...8 mm		
Sensitivity	Switching distance adjustable		
Installation	for flush mounting		
Housing material	PP		
Ambient temperature	-25...70 °C		
Operating voltage U_b	18...30 VDC		
Approval/conformity	UL Listed, CE, IO-Link		
IP rating	IP67		
Process data	Switch Point Sensor Value 0...4095		



Housing material definitions:
PP Polypropylene

CAPACITIVE SENSOR
AMPLIFIER



	BAE00LC BAE SA-CS-027-YI-BP00,3-GS04		
Dimension	10.5 x 45 x 75.5 mm		
Connection	M12x1-Male, 4-pole, A-coded		
Cable	PUR, 0.30 m		
Switching output	PNP/NPN NO/NC programmable		
Switching frequency	50 Hz		
Interface	IO-Link, PNP/NPN		
Range	n/a		
Sensitivity	Switching distance adjustable		
Installation	n/a		
Housing material	PBT		
Ambient temperature	-10...70 °C		
Operating voltage U_b	18...30 VDC		
Approval/conformity	CE, IO-Link, cULus		
IP rating	IP40		
Time function	On/off delay time programmable		
Process data	Switch Point Sensor Value 0...4095		

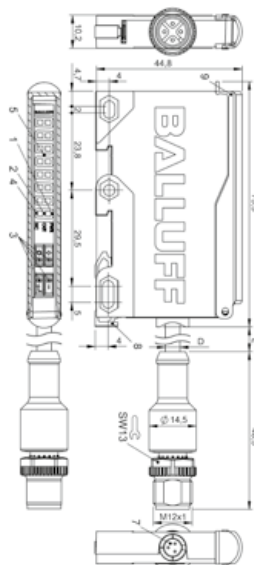

Housing material definitions:
PBT Polybuteneterephthalate

MAGNETIC FIELD SENSORS C-SLOT



	BMF00JJ BMF 203K-H-PI-C-A8-S4-00,3	BMF00K9 BMF 203K-H-PI-C-A8-S75-00,3	BMF00K8 BMF 203K-H-PI-C-A8-PU-02
Dimension	20 x 2.9 x 3.6 mm	20 x 2.9 x 3.6 mm	20 x 2.9 x 3.6 mm
Connection	M12x1-Male, 4-pole, A-coded	M8x1-Male, 4-pole	Cable out
Connection type	Cable with connector, 0.30 m, PUR	Cable with connector, 0.30 m, PUR	Cable, 2.00 m, PUR
Application	Pneumatic cylinder with C-slot	Pneumatic cylinder with C-slot	Pneumatic cylinder with C-slot.
Fastening detail	can be installed in C-slot from above	can be installed in C-slot from above	can be installed in C-slot from above
Housing material	PA 12	PA 12	PA 12
Interface	IO-Link 1.1	IO-Link 1.1	IO-Link 1.1
Switching output	PNP Normally open (NO)	PNP Normally open (NO)	PNP Normally open (NO)
Operating voltage U_b	10...30 VDC	10...30 VDC	10...30 VDC
Ambient temperature	-25...80 °C	-25...80 °C	-25...80 °C
IP rating	IP67	IP67	IP67
Approval/conformity	IO-Link, CE, cULus, DC, Code 81U2	CE, IO-Link, cULus, DC, Code 81U2	CE, IO-Link, cULus, DC, Code 81U2
Process data	8 switch points Signal stability	8 switch points Signal stability	8 switch points Signal stability

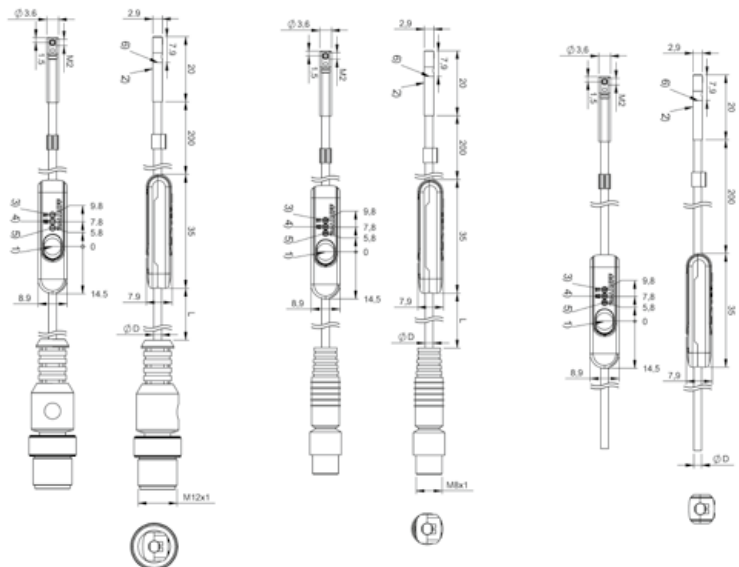

Housing material definitions:
PA Polyamide

MAGNETIC FIELD SENSORS
T-SLOT



	BMF00LC BMF 235K-H-PI-C-A8-S4-00,3	BMF00LA BMF 235K-H-PI-C-A8-S75-00,3	BMF00L5 BMF 235K-H-PI-C-A8-PU-02
Dimension	23.5 x 6.2 x 5 mm	23.5 x 6.2 x 5 mm	23.5 x 6.2 x 5 mm
Connection	M12x1-Male, 4-pole, A-coded	M8x1-Male, 4-pole	
Connection type	Cable with connector, 0.30 m, PUR	Cable with connector, 0.30 m, PUR	Cable, 2.00 m, PUR
Application	Pneumatic cylinder with T-slot	Pneumatic cylinder with T-slot	Pneumatic cylinder with T-slot
Fastening detail	can be installed in T-slot from above	can be installed in T-slot from above	can be installed in T-slot from above
Housing material	PA 12	PA 12	PA 12
Interface	IO-Link 1.1	IO-Link 1.1	IO-Link 1.1
Switching output	PNP Normally open (NO)	PNP Normally open (NO)	PNP Normally open (NO)
Operating voltage U_b	10...30 VDC	10...30 VDC	10...30 VDC
Ambient temperature	-25...80 °C	-25...80 °C	-25...80 °C
IP rating	IP67	IP67	IP67
Approval/conformity	CE, IO-Link, cULus, DC, Code 81U2, EAC	CE, IO-Link, cULus, DC, Code 81U2, EAC	CE, IO-Link, cULus, DC, Code 81U2, EAC
Process data	8 switch points Signal stability	8 switch points Signal stability	8 switch points Signal stability

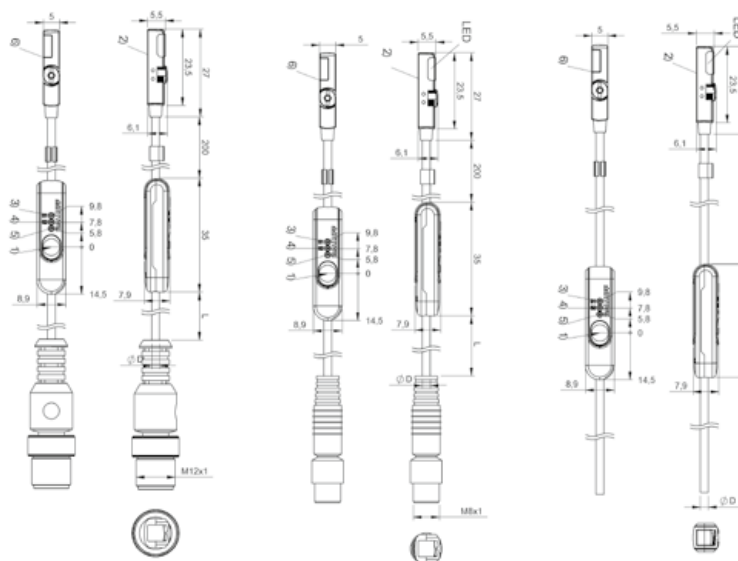

Housing material definitions:
PA Polyamide



ULTRASONIC SENSORS

	BUS0020 BUS M18M1-GPXI-02/015-S92G	BUS0029 BUS M18M1-GPXI-03/025-S92G	BUS004Z BUS M18M1-GPXI-07/035-S92G
Style	Cylinder Converter straight	Cylinder Converter straight	Cylinder Converter straight
Interface	IO-Link 1.0	IO-Link 1.0	IO-Link 1.0
Switching output	PNP/NPN NO/NC push-pull	PNP/NPN NO/NC push-pull	PNP/NPN NO/NC push-pull
Connection	Connector, M12x1-Male	Connector, M12x1-Male	Connector, M12x1-Male
Housing material	Brass PBT	Brass PBT	Brass PBT
Material sensing surface	PU foam epoxy resin glass	PU foam epoxy resin glass	PU foam epoxy resin glass
Resolution	≤ 0.070 mm	≤ 0.070 mm	≤ 0.069 mm
Range	25...250 mm	30...350 mm	65...600 mm
Switching frequency	25 Hz	25 Hz	12 Hz
Approval/conformity	CE	CE	CE
Ambient temperature	-25...70 °C	-25...70 °C	-25...70 °C
IP rating	IP67	IP67	IP67
Repeat accuracy	±0.15 % FS	±0.15 % FS	±0.15 % FS
Operating voltage U _b	10...30 VDC	10...30 VDC	10...30 VDC
Process data	Setpoint on/off Distance Value	Setpoint on/off Distance Value	Setpoint on/off Distance Value

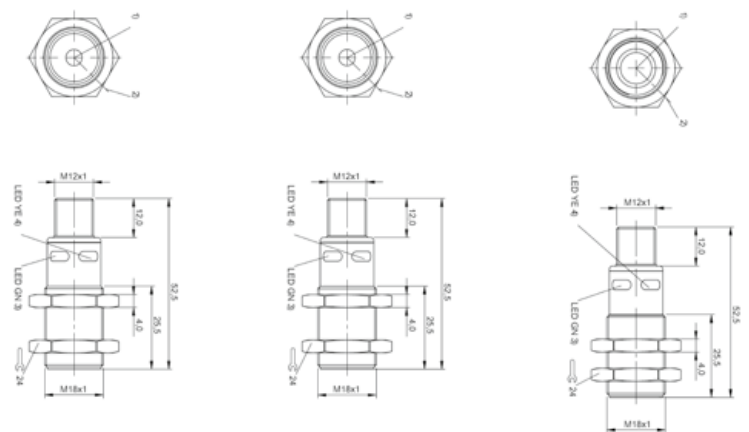

Housing material definitions:
PBT Polybuteneterephthalate



BUS004P BUS M18M1-GPXI-12/100-S92G	BUS0023 BUS W18M1-GPXI-02/015-S92G	BUS002A BUS W18M1-GPXI-03/025-S92G	BUS004Y BUS W18M1-GPXI-07/035-S92G	BUS004N BUS W18M1-GPXI-12/100-S92G
Cylinder Converter straight	Cylinder Converter 90°	Cylinder Converter 90°	Cylinder Converter 90°	Tubular angled
IO-Link 1.0	IO-Link 1.0	IO-Link 1.0	IO-Link 1.0	IO-Link 1.0
PNP/NPN NO/NC push-pull	PNP/NPN NO/NC push-pull	PNP/NPN NO/NC push-pull	PNP/NPN NO/NC push-pull	PNP/NPN NO/NC push-pull
Connector, M12x1-Male	Connector, M12x1-Male	Connector, M12x1-Male	Connector, M12x1-Male	Connector, M12x1-Male
Brass PBT	Brass PBT	Brass PBT	Brass PBT	Brass PBT
PU foam epoxy resin glass	PU foam epoxy resin glass	PU foam epoxy resin glass	PU foam epoxy resin glass	PU foam epoxy resin glass
≤ 0.069 mm	≤ 0.070 mm	≤ 0.070 mm	≤ 0.069 mm	≤ 0.069 mm
120...1300 mm	25...250 mm	30...350 mm	65...600 mm	120...1300 mm
10 Hz	25 Hz	25 Hz	12 Hz	10 Hz
CE	CE	CE	CE	CE
-25...70 °C	-25...70 °C	-25...70 °C	-25...70 °C	-25...70 °C
IP67	IP67	IP67	IP67	IP67
±0.15 % FS	±0.15 % FS	±0.15 % FS	±0.15 % FS	±0.15 % FS
10...30 VDC	10...30 VDC	10...30 VDC	10...30 VDC	10...30 VDC
Setpoint on/off Distance Value	Setpoint on/off Distance Value	Setpoint on/off Distance Value	Setpoint on/off Distance Value	Setpoint on/off Distance Value

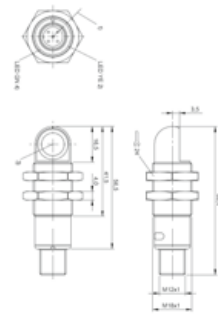
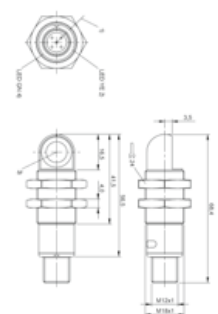
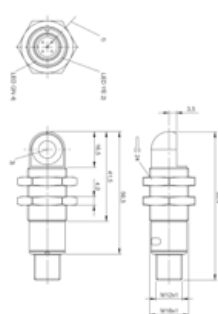
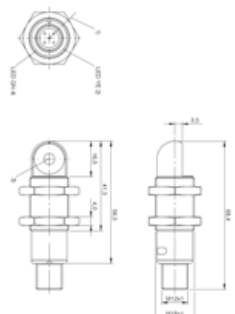
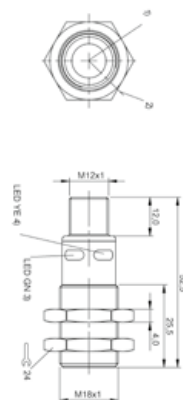

MULTIPLE POSITION
MECHANICAL SWITCHES



	BNS04T2 BNS 819-B05-D08-46-12-S4R-I	BNS04RA BNS 819-D04-D12-100-10-FD-S4L-I	BNS0510 BNS 819-D04-D12-62-10-FD-S4L-I	
Dimension	72 x 49 x 72 mm	120 x 85 x 90 mm	120 x 86 x 84 mm	
Housing material	Aluminum	Aluminum	Aluminum	
Number of switching positions	5x Chisel	4x Chisel	4x Chisel	
Version	Snap contact	Snap contact	Snap contact	
Operating principle	1-5. Switch position: Mechanical	1-4. Switch position: Mechanical	1-4. Switch position: Mechanical	
Switching frequency	Max 200/min	Max 200/min	Max 200/min	
Rated operating voltage Ue	24...28 VDC	24...28 VDC	24...28 VDC	
Installation	Vertical	Vertical	Vertical	
Approach direction	longitudinal, parallel to attachment surface	longitudinal, parallel to attachment surface	longitudinal, parallel to attachment surface	
Approach speed	1-5. Switch position: 20 m/min	1-4. Switch position: 40 m/min	1-4. Switch position: 40 m/min	
Switch position spacing	8 mm	12 mm	12 mm	
Connection type	1. Switch position: Connector	1. Switch position: Connector	1. Switch position: Connector	
Ambient temperature	-5...85 °C	-5...85 °C	-5...85 °C	
IP rating	IP67	IP67	IP67	
Approval/conformity	CE, IO-Link	CE, IO-Link	CE, IO-Link	

Other configurations available, contact the factory.

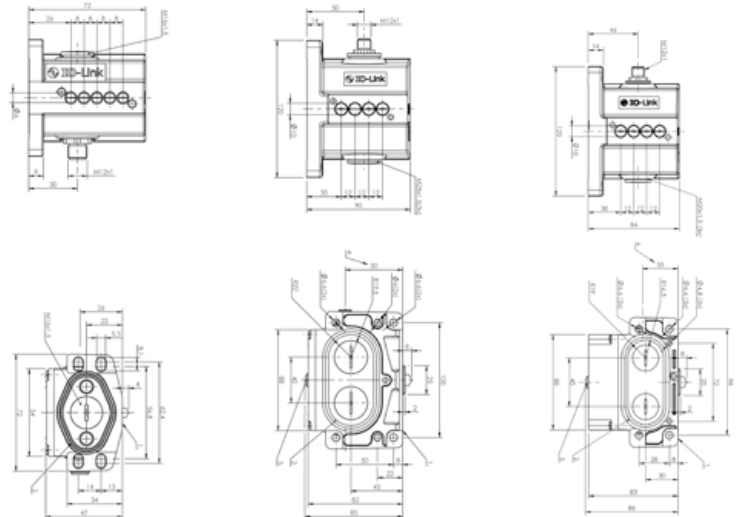



BNS04WF BNS 819-D04-D16-100-10-FD-S4R-I	BNS04RM BNS 819-D04-R12-100-10-FD-S4R-I			
120 x 85 x 105 mm	120 x 85 x 90 mm			
Aluminum	Aluminum			
4x Chisel	4x Roller			
Snap contact	Snap contact			
1-4. Switch position: Mechanical	1-4. Switch position: Mechanical			
Max 200/min	Max 200/min			
24...28 VDC	24...28 VDC			
Vertical	Vertical			
longitudinal, parallel to attachment surface	longitudinal, parallel to attachment surface			
1-4. Switch position: 40 m/min	1-4. Switch position: 60 m/min			
16 mm	12 mm			
1. Switch position: Connector	1. Switch position: Connector			
-5...85 °C	-5...85 °C			
IP67	IP67			
CE, IO-Link	CE, IO-Link			

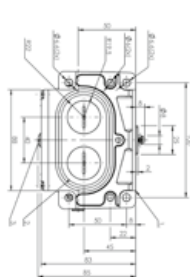
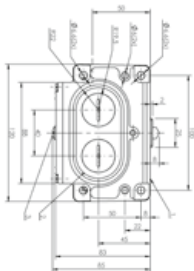
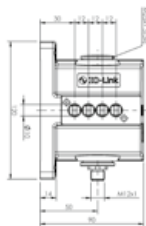
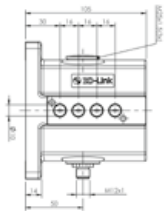

MAGNETOSTRICTIVE SENSORS
PROFILE STYLE



	BTL6 BTL6-U110-Mxxx-PF-S4
Style	Profile series
Fastening detail	Mounting clamps
Housing material	Aluminum
Magnets, number max.	1
Connection	Connector, M12x1, 4-pole
Interface	IO-Link 1.1
Measuring range	50...4572 mm
Sampling frequency max.	xxxx = 0050...1300: 1000 Hz xxxx = 1301...2700: 500 Hz xxxx = 2701...4572: 250 Hz
Resolution	≤ 5 μm
Non-linearity max.	xxxx = 0050...0500: ± 200 μm xxxx > 0500: ± 0.04% FS
Repeat accuracy	≤ 30 μm
Operating voltage U _b	18...30 VDC
Ambient temperature	-25...70 °C
IP rating	IP67 with connector
Approval/conformity	CE, cULus, EAC
Process data	Position value

M_ _ _ _
Sensing length in mm from 50 mm to 4572 mm

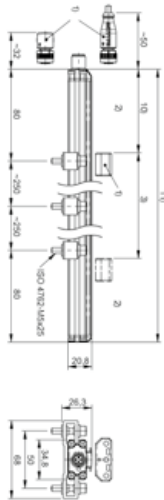

MAGNETOSTRICTIVE SENSORS ROD STYLE



	BTL6 BTL6-U110-Mxxx-B-S4	BTL6 BTL6-U110-Mxxx-Z-S4
Style	Rod series	Rod series
Fastening detail	Threaded flange M18x1.5	Threaded flange 3/4"-16 UNF
Housing material	Anodized aluminum	Anodized aluminum
Flange material	Stainless steel (1.3960)	Stainless steel (1.3960)
Protection tube material	Stainless steel (1.4571)	Stainless steel (1.4571)
Magnets, number max.	2; Minimum distance between position encoders 65 mm.	2; Minimum distance between position encoders 65 mm.
Connection	Connector, M12x1, 4-pole	Connector, M12x1, 4-pole
Interface	IO-Link 1.1	IO-Link 1.1
Measuring range	50...4572 mm	50...4572 mm
Sampling frequency max.	xxxx = 0050...1300: 1000 Hz xxxx = 1301...2700: 500 Hz xxxx = 2701...4572: 250 Hz	xxxx = 0050...1300: 1000 Hz xxxx = 1301...2700: 500 Hz xxxx = 2701...4572: 250 Hz
Resolution	5 µm	5 µm
Non-linearity max.	xxxx = 0050...0500: ± 200 µm xxxx > 0500: ± 0.04% FS	xxxx = 0050...0500: ± 200 µm xxxx > 0500: ± 0.04% FS
Repeat accuracy	≤ 30 µm	≤ 30 µm
Operating voltage U _b	18...30 VDC	18...30 VDC
Ambient temperature	-40...85 °C	-40...85 °C
IP rating	IP67 with connector	IP67 with connector
Approval/conformity	CE, cULus, EAC	CE, cULus, EAC
Process data	2x Configurable values: Position, Velocity, Difference between magnets, Internal device temperatures	2x Configurable values: Position, Velocity, Difference between magnets, Internal device temperatures

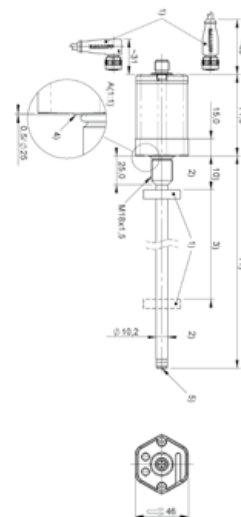
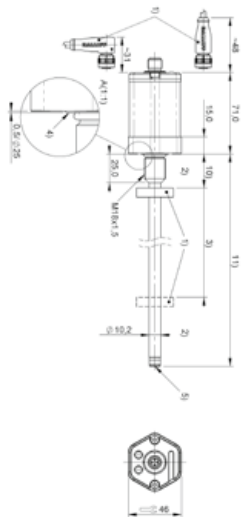



MAGNETIC ENCODERS

	BML06FU BML SL1-ALZ0-U1ZZ-AU1L-KA05	BML06HC BML SL1-ALZ0-U1ZZ-AU1L-S284	BML06HE BML SL1-ALZ0-U1ZZ-ZU1L-S4
Dimension	16 x 18.6 x 54 mm	16 x 18.6 x 54 mm	16 x 18.6 x 54 mm
Connection	Cable, 5 m, PUR	Connector, M12x1-Male, 12-pole	Connector, M12x1-Male, 4-pole
Housing material	Die-cast zinc	Die-cast zinc	Die-cast zinc
Interface	IO-Link 1.1	IO-Link 1.1	IO-Link 1.1
Analog output	Analog, sin/cos 1 Vpp	Analog, sin/cos 1 Vpp	
Measuring range	8190 mm	8190 mm	8190 mm
Resolution	1 µm	1 µm	1 µm
Read distance	0.01...1.3 mm	0.01...1.3 mm	0.01...1.3 mm
Non-linearity max.	±15 µm	±15 µm	±15 µm
Reference signal	absolute	absolute	absolute
Operating voltage Ub	18...30 VDC	18...30 VDC	18...30 VDC
Ambient temperature	-10...70 °C	-10...70 °C	-10...70 °C
IP rating	IP67	IP67	IP67
Approval/conformity	cURus, CE	cURus, CE	cURus, CE
Process data	Position Value 1 µm/digit	Position Value 1 µm/digit	Position Value 1 µm/digit

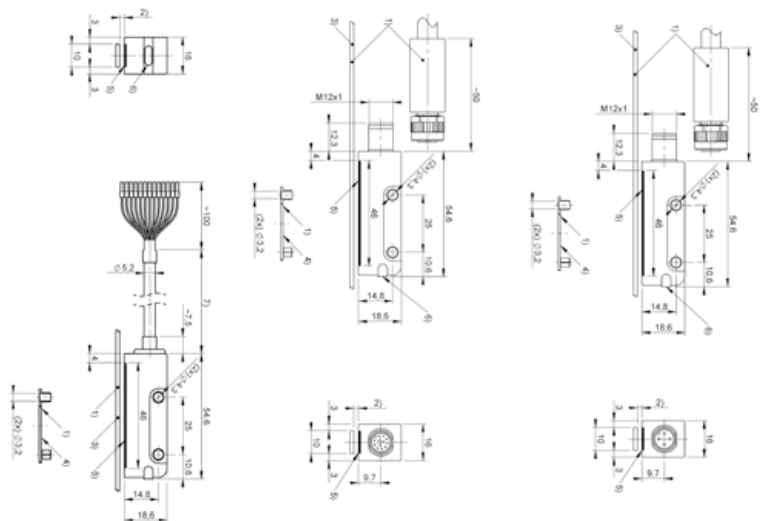



BML

BML TSC-ALCZ-1ZZZ-M_____ (0010 to 0819 = length in cm)

Min length: 10 mm x 1.55 mm x 10 cm
 Max length: 10 mm x 1.55 mm x 819 cm

Measuring range = length - 6 cm

-20...80 °C

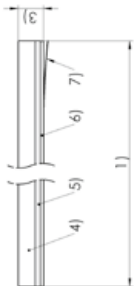
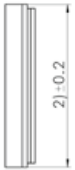



PRESSURE SENSORS – PNP



Two programmable switching points (NO or NC)



One programmable switching point and analog output 0...10 V DC



One programmable switching point and analog output 4...20 mA

-1...2 bar (-14.5...29 psi)	PNP	BSP0086 BSP V002-EV002-D00S1B-S4	BSP008L BSP V002-EV002-A00S1B-S4	BSP0091 BSP V002-EV002-A02S1B-S4
-1...10 bar (-14.5...145 psi)	PNP	BSP0087 BSP V010-EV002-D00S1B-S4	BSP008M BSP V010-EV002-A00S1B-S4	BSP0092 BSP V010-EV002-A02S1B-S4
0...2 bar (0...29 psi)	PNP	BSP0088 BSP B002-EV002-D00S1B-S4	BSP008N BSP B002-EV002-A00S1B-S4	BSP0093 BSP B002-EV002-A02S1B-S4
0...5 bar (0...73 psi)	PNP	BSP0089 BSP B005-EV002-D00S1B-S4	BSP008P BSP B005-EV002-A00S1B-S4	BSP0094 BSP B005-EV002-A02S1B-S4
0...10 bar (0...145 psi)	PNP	BSP008A BSP B010-EV002-D00S1B-S4	BSP008R BSP B010-EV002-A00S1B-S4	BSP0095 BSP B010-EV002-A02S1B-S4
0...20 bar (0...290 psi)	PNP	BSP008C BSP B020-EV002-D00S1B-S4	BSP008T BSP B020-EV002-A00S1B-S4	BSP0096 BSP B020-EV002-A02S1B-S4
0...50 bar (0...725 psi)	PNP	BSP008E BSP B050-EV002-D00S1B-S4	BSP008U BSP B050-EV002-A00S1B-S4	BSP0097 BSP B050-EV002-A02S1B-S4
0...100 bar (0...1450 psi)	PNP	BSP008F BSP B100-EV002-D00S1B-S4	BSP008W BSP B100-EV002-A00S1B-S4	BSP0098 BSP B100-EV002-A02S1B-S4
0...250 bar (0...3626 psi)	PNP	BSP008H BSP B250-EV002-D00S1B-S4	BSP008Y BSP B250-EV002-A00S1B-S4	BSP0099 BSP B250-EV002-A02S1B-S4
0...400 bar (0...5802 psi)	PNP	BSP008J BSP B400-EV002-D00S1B-S4	BSP008Z BSP B400-EV002-A00S1B-S4	BSP009A BSP B400-EV002-A02S1B-S4
0...600 bar (0...8702 psi)	PNP	BSP008K BSP B600-EV002-D00S1B-S4	BSP0090 BSP B600-EV002-A00S1B-S4	BSP009C BSP B600-EV002-A02S1B-S4
Interface		IO-Link 1.1	IO-Link 1.1	IO-Link 1.1
Connection		Connector, M12x1-Male, 4-pole	Connector, M12x1-Male, 4-pole	Connector, M12x1-Male, 4-pole
Housing material		Stainless steel (1.4301), PA 6.6	Stainless steel (1.4301), PA 6.6	Stainless steel (1.4301), PA 6.6
Accuracy		±0.5 % FSO BFSL	±0.5 % FSO BFSL	±0.5 % FSO BFSL
Ambient temperature		-25...85 °C	-25...85 °C	-25...85 °C
Media temperature		-40...125 °C	-40...125 °C	-40...125 °C
Operating voltage U _b		18...30 VDC	18...30 VDC	18...30 VDC
IP rating		IP67	IP67	IP67
Process connection		G 1/4" (DIN 3852)	G 1/4" (DIN 3852)	G 1/4" (DIN 3852)

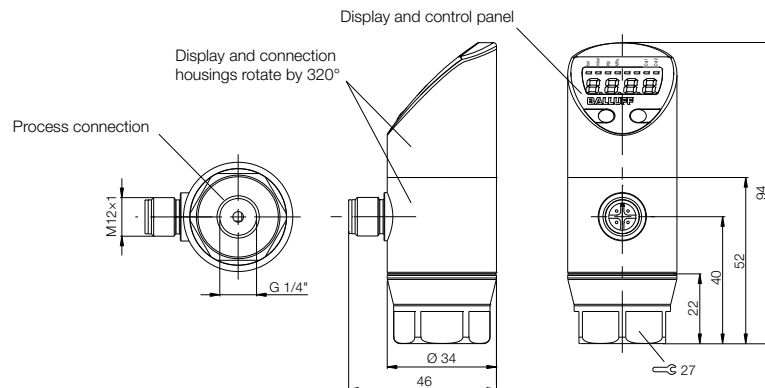

Housing material definitions:
PA Polyamide



PRESSURE SENSORS – NPN



Two programmable switching points (NO or NC)



One programmable switching point and analog output 0...10 V DC



One programmable switching point and analog output 4...20 mA

-1...2 bar (-14.5...29 psi)	NPN	BSP009U BSP V002-EV002-D01S1B-S4	BSP00C2 BSP V002-EV002-A01S1B-S4	BSP009E BSP V002-EV002-A03S1B-S4
-1...10 bar (-14.5...145 psi)	NPN	BSP009W BSP V010-EV002-D01S1B-S4	BSP00C3 BSP V010-EV002-A01S1B-S4	BSP009F BSP V010-EV002-A03S1B-S4
0...2 bar (0...29 psi)	NPN	BSP009Y BSP B002-EV002-D01S1B-S4	BSP00C4 BSP B002-EV002-A01S1B-S4	BSP009H BSP B002-EV002-A03S1B-S4
0...5 bar (0...73 psi)	NPN	BSP009Z BSP B005-EV002-D01S1B-S4	BSP00C5 BSP B005-EV002-A01S1B-S4	BSP009J BSP B005-EV002-A03S1B-S4
0...10 bar (0...145 psi)	NPN	BSP00A0 BSP B010-EV002-D01S1B-S4	BSP00C6 BSP B010-EV002-A01S1B-S4	BSP009K BSP B010-EV002-A03S1B-S4
0...20 bar (0...290 psi)	NPN	BSP00A1 BSP B020-EV002-D01S1B-S4	BSP00C7 BSP B020-EV002-A01S1B-S4	BSP009L BSP B020-EV002-A03S1B-S4
0...50 bar (0...725 psi)	NPN	BSP00A2 BSP B050-EV002-D01S1B-S4	BSP00C8 BSP B050-EV002-A01S1B-S4	BSP009M BSP B050-EV002-A03S1B-S4
0...100 bar (0...1450 psi)	NPN	BSP00A3 BSP B100-EV002-D01S1B-S4	BSP00C9 BSP B100-EV002-A01S1B-S4	BSP009N BSP B100-EV002-A03S1B-S4
0...250 bar (0...3626 psi)	NPN	BSP00A4 BSP B250-EV002-D01S1B-S4	BSP00CA BSP B250-EV002-A01S1B-S4	BSP009P BSP B250-EV002-A03S1B-S4
0...400 bar (0...5802 psi)	NPN	BSP00A5 BSP B400-EV002-D01S1B-S4	BSP00CC BSP B400-EV002-A01S1B-S4	BSP009R BSP B400-EV002-A03S1B-S4
0...600 bar (0...8702 psi)	NPN	BSP00A6 BSP B600-EV002-D01S1B-S4	BSP00CE BSP B600-EV002-A01S1B-S4	BSP009T BSP B600-EV002-A03S1B-S4
Interface		IO-Link 1.1	IO-Link 1.1	IO-Link 1.1
Connection		Connector, M12x1-Male, 4-pole	Connector, M12x1-Male, 4-pole	Connector, M12x1-Male, 4-pole
Housing material		Stainless steel (1.4301), PA 6.6	Stainless steel (1.4301), PA 6.6	Stainless steel (1.4301), PA 6.6
Accuracy		±0.5 % FSO BFSL	±0.5 % FSO BFSL	±0.5 % FSO BFSL
Ambient temperature		-25...85 °C	-25...85 °C	-25...85 °C
Media temperature		-40...125 °C	-40...125 °C	-40...125 °C
Operating voltage Ub		18...30 VDC	18...30 VDC	18...30 VDC
IP rating		IP67	IP67	IP67
Process connection		G 1/4" (DIN 3852)	G 1/4" (DIN 3852)	G 1/4" (DIN 3852)

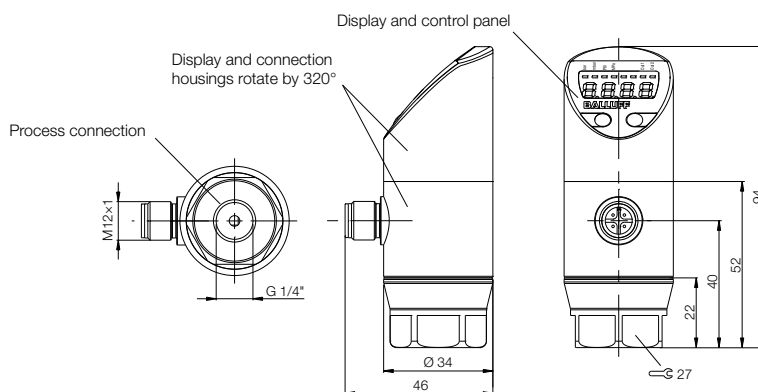



PRESSURE SENSORS – PNP



Two programmable switching points (NO or NC)



One programmable switching point and analog output 0...10 V DC



One programmable switching point and analog output 4...20 mA

-1...2 bar (-14.5...29 psi)	PNP	BSP00CF BSP V002-EV003-D00S1B-S4	BSP00AM BSP V002-EV003-A00S1B-S4	BSP00A7 BSP V002-EV003-A02S1B-S4
-1...10 bar (-14.5...145 psi)	PNP	BSP00CH BSP V010-EV003-D00S1B-S4	BSP00AN BSP V010-EV003-A00S1B-S4	BSP00A8 BSP V010-EV003-A02S1B-S4
0...2 bar (0...29 psi)	PNP	BSP00CJ BSP B002-EV003-D00S1B-S4	BSP00AP BSP B002-EV003-A00S1B-S4	BSP00A9 BSP B002-EV003-A02S1B-S4
0...5 bar (0...73 psi)	PNP	BSP00CK BSP B005-EV003-D00S1B-S4	BSP00AR BSP B005-EV003-A00S1B-S4	BSP00AA BSP B005-EV003-A02S1B-S4
0...10 bar (0...145 psi)	PNP	BSP00CL BSP B010-EV003-D00S1B-S4	BSP00AT BSP B010-EV003-A00S1B-S4	BSP00AC BSP B010-EV003-A02S1B-S4
0...20 bar (0...290 psi)	PNP	BSP00CM BSP B020-EV003-D00S1B-S4	BSP00AU BSP B020-EV003-A00S1B-S4	BSP00AE BSP B020-EV003-A02S1B-S4
0...50 bar (0...725 psi)	PNP	BSP00CN BSP B050-EV003-D00S1B-S4	BSP00AW BSP B050-EV003-A00S1B-S4	BSP00AF BSP B050-EV003-A02S1B-S4
0...100 bar (0...1450 psi)	PNP	BSP00CP BSP B100-EV003-D00S1B-S4	BSP00AY BSP B100-EV003-A00S1B-S4	BSP00AH BSP B100-EV003-A02S1B-S4
0...250 bar (0...3626 psi)	PNP	BSP00CR BSP B250-EV003-D00S1B-S4	BSP00AZ BSP B250-EV003-A00S1B-S4	BSP00AJ BSP B250-EV003-A02S1B-S4
0...400 bar (0...5802 psi)	PNP	BSP00CT BSP B400-EV003-D00S1B-S4	BSP00C0 BSP B400-EV003-A00S1B-S4	BSP00AK BSP B400-EV003-A02S1B-S4
0...600 bar (0...8702 psi)	PNP	BSP00CU BSP B600-EV003-D00S1B-S4	BSP00C1 BSP B600-EV003-A00S1B-S4	BSP00AL BSP B600-EV003-A02S1B-S4
Interface		IO-Link 1.1	IO-Link 1.1	IO-Link 1.1
Connection		Connector, M12x1-Male, 4-pole	Connector, M12x1-Male, 4-pole	Connector, M12x1-Male, 4-pole
Housing material		Stainless steel	Stainless steel	Stainless steel
Accuracy		±0.5 % FSO BFSL	±0.5 % FSO BFSL	±0.5 % FSO BFSL
Ambient temperature		-25...85 °C	-25...85 °C	-25...85 °C
Media temperature		-40...125 °C	-40...125 °C	-40...125 °C
Operating voltage U _b		18...30 VDC	18...30 VDC	18...30 VDC
IP rating		IP67	IP67	IP67
Process connection		G 1/4" (DIN 3852)	G 1/4" (DIN 3852)	G 1/4" (DIN 3852)

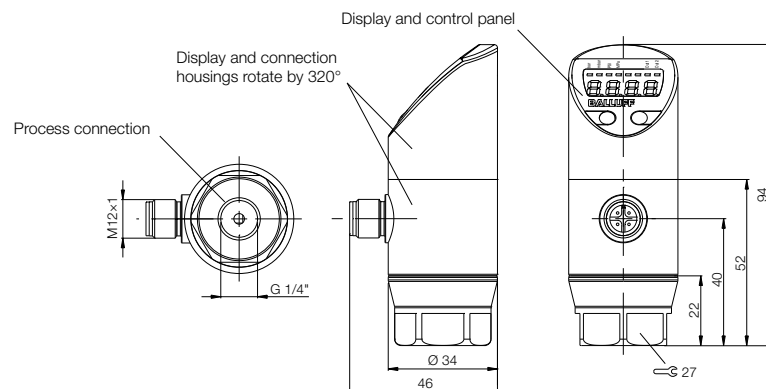



PRESSURE SENSORS – NPN



Two programmable switching points (NO or NC)



One programmable switching point and analog output 0...10 V DC



One programmable switching point and analog output 4...20 mA

-1...2 bar (-14.5...29 psi)	NPN	BSP00CW BSP V002-EV003-D01S1B-S4	BSP00E8 BSP V002-EV003-A01S1B-S4	BSP00EN BSP V002-EV003-A03S1B-S4
-1...10 bar (-14.5...145 psi)	NPN	BSP00CY BSP V010-EV003-D01S1B-S4	BSP00E9 BSP V010-EV003-A01S1B-S4	BSP00EP BSP V010-EV003-A03S1B-S4
0...2 bar (0...29 psi)	NPN	BSP00CZ BSP B002-EV003-D01S1B-S4	BSP00EA BSP B002-EV003-A01S1B-S4	BSP00ER BSP V010-EV003-A03S1B-S4
0...5 bar (0...73 psi)	NPN	BSP00E0 BSP B005-EV003-D01S1B-S4	BSP00EC BSP B005-EV003-A01S1B-S4	BSP00ET BSP B005-EV003-A03S1B-S4
0...10 bar (0...145 psi)	NPN	BSP00E1 BSP B010-EV003-D01S1B-S4	BSP00EE BSP B010-EV003-A01S1B-S4	BSP00EU BSP B010-EV003-A03S1B-S4
0...20 bar (0...290 psi)	NPN	BSP00E2 BSP B020-EV003-D01S1B-S4	BSP00EF BSP B020-EV003-A01S1B-S4	BSP00EW BSP B020-EV003-A03S1B-S4
0...50 bar (0...725 psi)	NPN	BSP00E3 BSP B050-EV003-D01S1B-S4	BSP00EH BSP B050-EV003-A01S1B-S4	BSP00EY BSP B020-EV003-A03S1B-S4
0...100 bar (0...1450 psi)	NPN	BSP00E4 BSP B100-EV003-D01S1B-S4	BSP00EJ BSP B100-EV003-A01S1B-S4	BSP00EZ BSP B100-EV003-A03S1B-S4
0...250 bar (0...3626 psi)	NPN	BSP00E5 BSP B250-EV003-D01S1B-S4	BSP00EK BSP B250-EV003-A01S1B-S4	BSP00F0 BSP B250-EV003-A03S1B-S4
0...400 bar (0...5802 psi)	NPN	BSP00E6 BSP B400-EV003-D01S1B-S4	BSP00EL BSP B400-EV003-A01S1B-S4	BSP00F1 BSP B400-EV003-A03S1B-S4
0...600 bar (0...8702 psi)	NPN	BSP00E7 BSP B600-EV003-D01S1B-S4	BSP00EM BSP B600-EV003-A01S1B-S4	BSP00F2 BSP B600-EV003-A03S1B-S4
Interface		IO-Link 1.1	IO-Link 1.1	IO-Link 1.1
Connection		Connector, M12x1-Male, 4-pole	Connector, M12x1-Male, 4-pole	Connector, M12x1-Male, 4-pole
Housing material		Stainless steel	Stainless steel	Stainless steel
Accuracy		±0.5 % FSO BFSL	±0.5 % FSO BFSL	±0.5 % FSO BFSL
Ambient temperature		-25...85 °C	-25...85 °C	-25...85 °C
Media temperature		-40...125 °C	-40...125 °C	-40...125 °C
Operating voltage Ub		18...30 VDC	18...30 VDC	18...30 VDC
IP rating		IP67	IP67	IP67
Process connection		G 1/4" (DIN 3852)	G 1/4" (DIN 3852)	G 1/4" (DIN 3852)

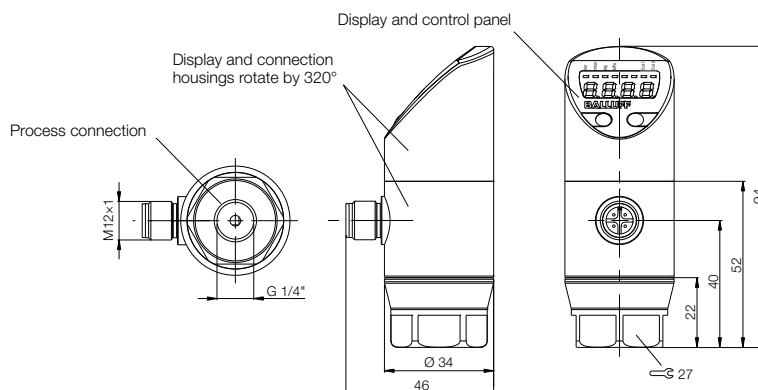



PRESSURE SENSORS – PNP NO/NC



Process connection G 1/4"



Process connection NPT 1/4"

-1...2 bar (-14.5...29 psi)	PNP NO/NC	BSP00PJ BSP V002-DV004-D06S1A-S4	BSP00T5 BSP V002-FV004-D06S1A-S4
-1...10 bar (-14.5...145 psi)	PNP NO/NC	BSP00PK BSP V010-DV004-D06S1A-S4	BSP00T6 BSP V010-FV004-D06S1A-S4
0...2 bar (0...29 psi)	PNP NO/NC	BSP00PL BSP B002-DV004-D06S1A-S4	BSP00T7 BSP B002-FV004-D06S1A-S4
0...5 bar (0...73 psi)	PNP NO/NC	BSP00PM BSP B005-DV004-D06S1A-S4	BSP00T8 BSP B005-FV004-D06S1A-S4
0...10 bar (0...145 psi)	PNP NO/NC	BSP00PN BSP B010-DV004-D06S1A-S4	BSP00T9 BSP B010-FV004-D06S1A-S4
0...20 bar (0...290 psi)	PNP NO/NC	BSP00PP BSP B020-DV004-D06S1A-S4	BSP00TA BSP B020-FV004-D06S1A-S4
0...50 bar (0...725 psi)	PNP NO/NC	BSP00PR BSP B050-DV004-D06S1A-S4	BSP00TC BSP B050-FV004-D06S1A-S4
0...100 bar (0...1450 psi)	PNP NO/NC	BSP00PT BSP B100-DV004-D06S1A-S4	BSP00TE BSP B100-FV004-D06S1A-S4
0...250 bar (0...3626 psi)	PNP NO/NC	BSP00PU BSP B250-DV004-D06S1A-S4	BSP00TF BSP B250-FV004-D06S1A-S4
0...400 bar (0...5802 psi)	PNP NO/NC	BSP00PW BSP B400-DV004-D06S1A-S4	BSP00TH BSP B400-FV004-D06S1A-S4
0...600 bar (0...8702 psi)	PNP NO/NC	BSP00PY BSP B600-DV004-D06S1A-S4	BSP00TJ BSP B600-FV004-D06S1A-S4
Interface		IO-Link 1.1	IO-Link 1.1
Connection		Connector, M12x1-Male, 4-pole	Connector, M12x1-Male, 4-pole
Housing material		Stainless steel	Stainless steel
Accuracy		±0.5 % FSO BFSL	±0.5 % FSO BFSL
Ambient temperature		-25...85 °C	-25...85 °C
Media temperature		-40...125 °C	-40...125 °C
Operating voltage U_b		18...30 VDC	18...30 VDC
IP rating		IP67	IP67
Process connection		G 1/4" (DIN 3852)	NPT 1/4"

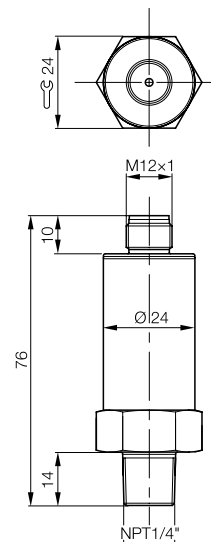
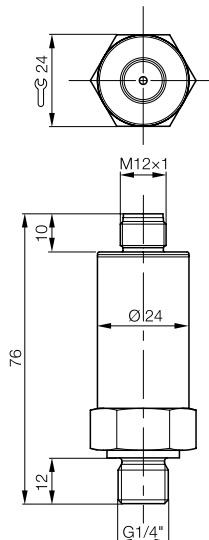



BSP00UC BSP V002-KV004-D06S1A-S4	BSP00RR BSP V002-HV004-D06S1A-S4	
BSP00UE BSP V010-KV004-D06S1A-S4	BSP00RT BSP V010-HV004-D06S1A-S4	
BSP00UF BSP B002-KV004-D06S1A-S4	BSP00RU BSP B002-HV004-D06S1A-S4	
BSP00UH BSP B005-KV004-D06S1A-S4	BSP00RW BSP B005-HV004-D06S1A-S4	
BSP00UJ BSP B010-KV004-D06S1A-S4	BSP00RY BSP B010-HV004-D06S1A-S4	
BSP00UK BSP B020-KV004-D06S1A-S4	BSP00RZ BSP B020-HV004-D06S1A-S4	
BSP00UL BSP B050-KV004-D06S1A-S4	BSP00T0 BSP B050-HV004-D06S1A-S4	
BSP00UM BSP B100-KV004-D06S1A-S4	BSP00T1 BSP B100-HV004-D06S1A-S4	
BSP00UN BSP B250-KV004-D06S1A-S4	BSP00T2 BSP B250-HV004-D06S1A-S4	
BSP00UP BSP B400-KV004-D06S1A-S4	BSP00T3 BSP B400-HV004-D06S1A-S4	
BSP00UR BSP B600-KV004-D06S1A-S4	BSP00T4 BSP B600-HV004-D06S1A-S4	
IO-Link 1.1	IO-Link 1.1	
Connector, M12x1-Male, 4-pole	Connector, M12x1-Male, 4-pole	
Stainless steel	Stainless steel	
±0.5 % FSO BFSL	±0.5 % FSO BFSL	
-25...85 °C	-25...85 °C	
-40...125 °C	-40...125 °C	
18...30 VDC	18...30 VDC	
IP67	IP67	
R 1/4"	G 1/2" (DIN 3852)	

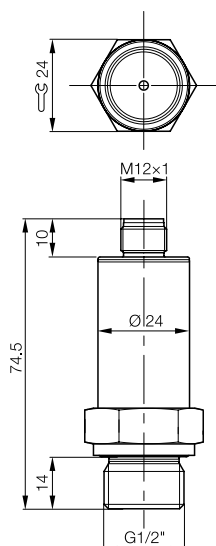
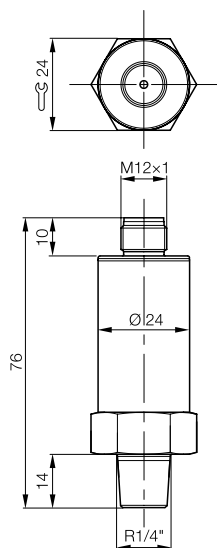

PRESSURE SENSORS – NPN NO/NC



Process connection G 1/4"



Process connection NPT 1/4"

-1...2 bar (-14.5...29 psi)	NPN NO/NC	BSP00PZ BSP V002-DV004-D05S1A-S4	BSP00TK BSP V002-FV004-D05S1A-S4
-1...10 bar (-14.5...145 psi)	NPN NO/NC	BSP00R0 BSP V010-DV004-D05S1A-S4	BSP00TL BSP V010-FV004-D05S1A-S4
0...2 bar (0...29 psi)	NPN NO/NC	BSP00R1 BSP B002-DV004-D05S1A-S4	BSP00TM BSP B002-FV004-D05S1A-S4
0...5 bar (0...73 psi)	NPN NO/NC	BSP00R2 BSP B005-DV004-D05S1A-S4	BSP00TN BSP B005-FV004-D05S1A-S4
0...10 bar (0...145 psi)	NPN NO/NC	BSP00R3 BSP B010-DV004-D05S1A-S4	BSP00TP BSP B010-FV004-D05S1A-S4
0...20 bar (0...290 psi)	NPN NO/NC	BSP00R4 BSP B020-DV004-D05S1A-S4	BSP00TR BSP B020-FV004-D05S1A-S4
0...50 bar (0...725 psi)	NPN NO/NC	BSP00R5 BSP B050-DV004-D05S1A-S4	BSP00TT BSP B050-FV004-D05S1A-S4
0...100 bar (0...1450 psi)	NPN NO/NC	BSP00R6 BSP B100-DV004-D05S1A-S4	BSP00TU BSP B100-FV004-D05S1A-S4
0...250 bar (0...3626 psi)	NPN NO/NC	BSP00R7 BSP B250-DV004-D05S1A-S4	BSP00TW BSP B250-FV004-D05S1A-S4
0...400 bar (0...5802 psi)	NPN NO/NC	BSP00R8 BSP B400-DV004-D05S1A-S4	BSP00TY BSP B400-FV004-D05S1A-S4
0...600 bar (0...8702 psi)	NPN NO/NC	BSP00R9 BSP B600-DV004-D05S1A-S4	BSP00TZ BSP B600-FV004-D05S1A-S4
Interface		IO-Link 1.1	IO-Link 1.1
Connection		Connector, M12x1-Male, 4-pole	Connector, M12x1-Male, 4-pole
Housing material		Stainless steel	Stainless steel
Accuracy		±0.5 % FSO BFSL	±0.5 % FSO BFSL
Ambient temperature		-25...85 °C	-25...85 °C
Media temperature		-40...125 °C	-40...125 °C
Operating voltage U _b		18...30 VDC	18...30 VDC
IP rating		IP67	IP67
Process connection		G 1/4" (DIN 3852)	NPT 1/4"

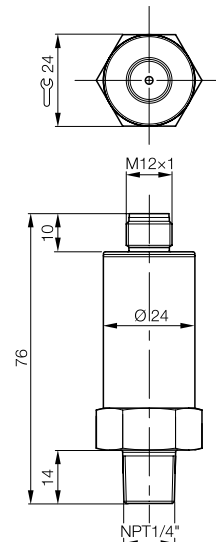
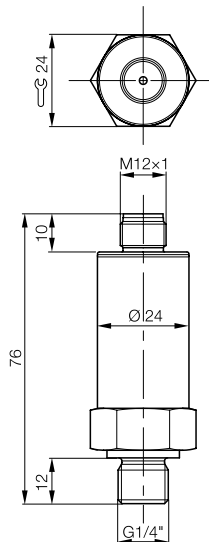



BSP00U0 BSP V002-KV004-D05S1A-S4	BSP00RA BSP V002-HV004-D05S1A-S4	
BSP00U1 BSP V010-KV004-D05S1A-S4	BSP00RC BSP V010-HV004-D05S1A-S4	
BSP00U2 BSP B002-KV004-D05S1A-S4	BSP00RE BSP B002-HV004-D05S1A-S4	
BSP00U3 BSP B005-KV004-D05S1A-S4	BSP00RF BSP B005-HV004-D05S1A-S4	
BSP00U4 BSP B010-KV004-D05S1A-S4	BSP00RH BSP B010-HV004-D05S1A-S4	
BSP00U5 BSP B020-KV004-D05S1A-S4	BSP00RJ BSP B020-HV004-D05S1A-S4	
BSP00U6 BSP B020-KV004-D05S1A-S4	BSP00RK BSP B050-HV004-D05S1A-S4	
BSP00U7 BSP B100-KV004-D05S1A-S4	BSP00RL BSP B100-HV004-D05S1A-S4	
BSP00U8 BSP B250-KV004-D05S1A-S4	BSP00RM BSP B250-HV004-D05S1A-S4	
BSP00U9 BSP B400-KV004-D05S1A-S4	BSP00RN BSP B400-HV004-D05S1A-S4	
BSP00UA BSP B600-KV004-D05S1A-S4	BSP00RP BSP B600-HV004-D05S1A-S4	
IO-Link 1.1	IO-Link 1.1	
Connector, M12x1-Male, 4-pole	Connector, M12x1-Male, 4-pole	
Stainless steel	Stainless steel	
±0.5 % FSO BFSL	±0.5 % FSO BFSL	
-25...85 °C	-25...85 °C	
-40...125 °C	-40...125 °C	
18...30 VDC	18...30 VDC	
IP67	IP67	
R 1/4"	G 1/2" (DIN 3852)	

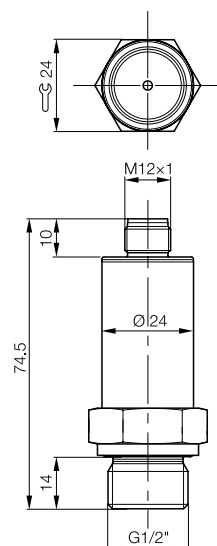
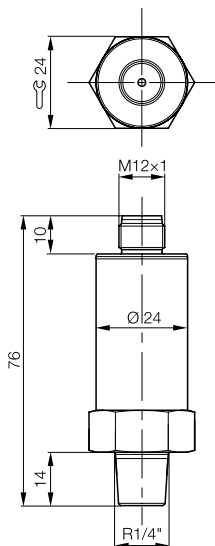



Process connection
G 1/2"



Process connection
1-1/2" Clamp

PRESSURE SENSORS – PNP

-1...50 bar (-14.5...725 psi)	PNP	BSP00LR BSP V050-HV002-D00S1B-S4-001	
0...10 bar (0...145 psi)	PNP	BSP00LP BSP B010-HV002-D00S1B-S4-001	
0...100 mbar (0...1.4 psi)	PNP		BSP00UT BSP M100-ZT006-A02S1B-S4-006
0...250 mbar (0...3.6 psi)	PNP		BSP00UU BSP M250-ZT006-A02S1B-S4-006
0...500 mbar (0...7.2 psi)	PNP		BSP00UW BSP M500-ZT006-A02S1B-S4-006
0...750 mbar (0...10.8 psi)	PNP		BSP00UY BSP M750-ZT006-A02S1B-S4-006
0 mbar...1 bar (0...14.5 psi)	PNP		BSP00UZ BSP B001-ZT006-A02S1B-S4-006
0 mbar...2 bar (0...29 psi)	PNP		BSP00W0 BSP B002-ZT006-A02S1B-S4-006
Interface		IO-Link 1.1	IO-Link 1.1
Connection		Connector, M12x1-Male, 4-pole	Connector, M12x1-Male, 4-pole
Housing material		PVDF	Stainless steel (1.4404)
Accuracy		±0.5 % FSO BFSL	±0.25 % FSO BFSL
Ambient temperature		-25...85 °C	-40...85 °C
Media temperature		-25...125 °C	-10...125 °C
Operating voltage U_b		18...36 VDC	18...36 VDC
IP rating		IP67	IP67
Process connection		G 1/2"	1 1/2" Clamp

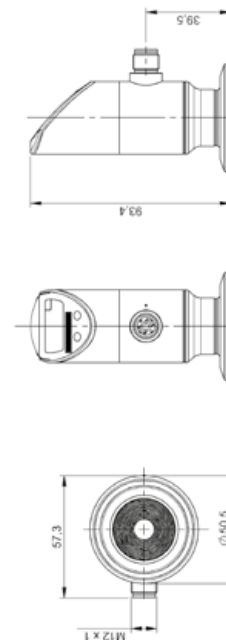
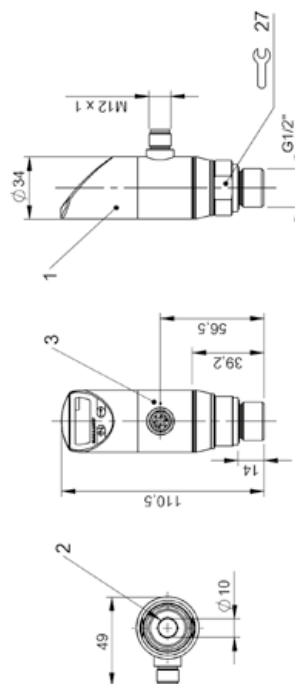



Housing material definitions:
PVDF Polyvinylidenfluoride

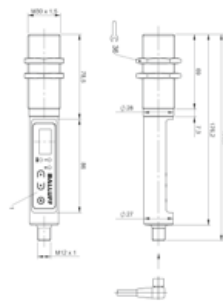

TEMPERATURE SENSOR

	BTS0002 BTS M30E0-UUI-H0001-S04G		
Measuring range	250...1250 °C		
Temperature resolution	1 °C, 1 °F, 1 %		
Reproducibility	±1 °C		
Wave length	1200...1700 nm		
Distance ratio	50:1		
Dimension	Ø 30 x 190 mm		
Connection	M12x1-Male, 4-pole		
Operating voltage U_b	10...30 VDC		
Switching output	2x PNP NO/NC		
Interface	IO-Link 1.1		
Material sensing surface	Borosilicate crown glass (N-BK7), coated		
Housing material	Stainless steel (1.4404), Stainless steel (1.4404) Aluminum, black anodized, Aluminum (3.3206)		
IP rating	IP65, IP67		
Ambient temperature	-5...65 °C		
Process data	2x Switch point, Temperature value, Out of range		





Automatic identification and tracking in production

RFID – RADIO FREQUENCY IDENTIFICATION

 *innovating automation*



Our industrial RFID systems help to give you visibility in a modern production facility. Objects can be automatically identified and traced using RFID. To do this, a data carrier that functions as a memory is attached to the object to be identified. The data is transferred between the data carrier and read/write head and via the processor unit to the controller.

Balluff offers a broad selection of innovative products for the low frequency (LF), high frequency (HF) and ultra-high frequency (UHF) range. With the BIS V frequency-independent processor unit, all systems can be flexibly combined with each other.

Your Balluff solutions

- RFID system HF (13.56 MHz) BIS M read/write heads
- RFID system LF (125 kHz) BIS L read only heads
- RFID system LF (125 kHz) BIS V IO-Link master

RFID SYSTEM HF (13.56 MHz) BIS M
READ/WRITE HEADS

	BIS0134 BIS M-400-045-001-07-S4-SA1	BIS00LH BIS M-400-045-001-07-S4	BIS0108 BIS M-400-072-001-07-S4	
Product group	HF (13.56 MHz)	HF (13.56 MHz)	HF (13.56 MHz)	
Dimension	Ø 30 x 83 mm	Ø 30 x 83 mm	Ø 30 x 83 mm	
Installation	with clear zone (in steel)	with clear zone (in steel)	with clear zone (in steel)	
Antenna type	round	round	round	
Connection	M12x1-Male, 4-pole, A-coded	M12x1-Male, 4-pole, A-coded	M12x1-Male, 4-pole, A-coded	
Housing material	Brass, Nickel-plated brass nuts	Brass, Nickel-plated brass nuts	Brass, Nickel-plated brass nuts	
Interface	IO-Link 1.0	IO-Link 1.1	IO-Link 1.1	
Operating voltage U_b	18...30 VDC Supports only LPS/Class 2	18...30 VDC Supports only LPS/Class 2	18...30 VDC Supports only LPS/Class 2	
Ambient temperature	0...70 °C	0...70 °C	0...70 °C	
IP rating	IP67	IP67	IP67	
Approval/conformity	CE, UL-FILE E227256, Vol. X1, BIS	UL-FILE E227256, Vol.X1, BIS, CE	CE, UL-FILE E227256, Vol. X1, BIS	
Process data	10 byte buffer	10 byte buffer	32 byte buffer	

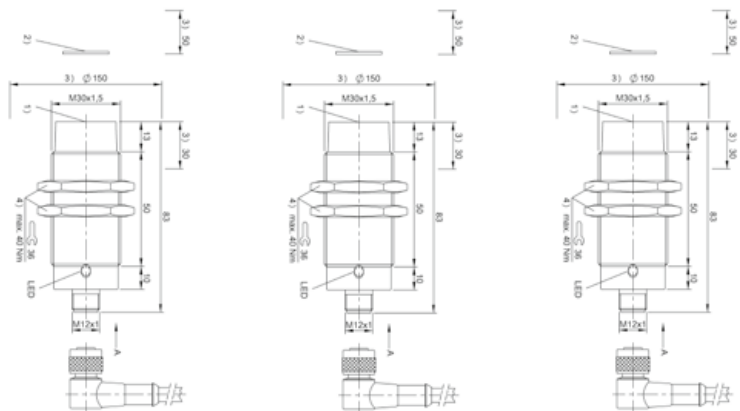

Housing material definitions:
PA Polyamide



BIS0157 BIS M-406-045-001-07-S4	BIS015T BIS M-400-045-401-07-S4	BIS00LJ BIS M-400-045-002-07-S4	BIS0104 BIS M-400-072-002-07-S4	BIS015R BIS M-404-045-401-07-S4
HF (13.56 MHz)	HF (13.56 MHz)	HF (13.56 MHz)	HF (13.56 MHz)	HF (13.56 MHz)
Ø 30 x 83 mm	Ø 30 x 65.9 mm	Ø 30 x 109.5 mm	Ø 30 x 109.5 mm	Ø 18 x 65 mm
with clear zone (in steel)	for flush mounting (in steel)	with clear zone (in steel)	with clear zone (in steel)	for flush mounting (in steel)
round	round	round	round	round
M12x1-Male, 4-pole, A-coded	M12x1-Male, 4-pole, A-coded	M12x1-Male, 4-pole, A-coded	M12x1-Male, 4-pole, A-coded	M12x1-Male, 4-pole, A-coded
Stainless steel (1.4404), Adapter PA 6	Brass, Nickel-plated brass nuts	Brass, Nickel-plated brass nuts	Brass, Nickel-plated brass nuts	Brass, Nickel-plated brass nuts
IO-Link 1.1	IO-Link 1.1	IO-Link 1.1	IO-Link 1.1	IO-Link 1.1
18...30 VDC Supports only LPS/Class 2	18...30 VDC Supports only LPS/Class 2	18...30 VDC Supports only LPS/Class 2	18...30 VDC Supports only LPS/Class 2	18...30 VDC Supports only LPS/Class 2
0...70 °C	0...70 °C	0...70 °C	0...70 °C	0...70 °C
IP68	IP67	IP67	IP67	IP67
UL-FILE E227256, Vol.X1, BIS, CE, Ecolab	CE	UL-FILE E227256, Vol.X1, BIS, CE	CE, UL-FILE E227256, Vol. X1, BIS	CE
10 byte buffer	10 byte buffer	10 byte buffer	32 byte buffer	10 byte buffer

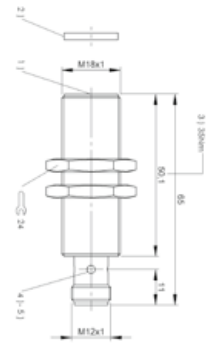
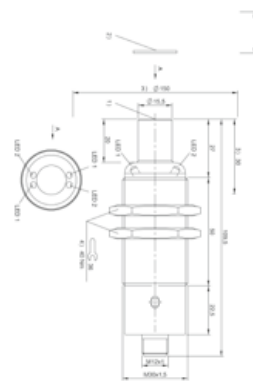
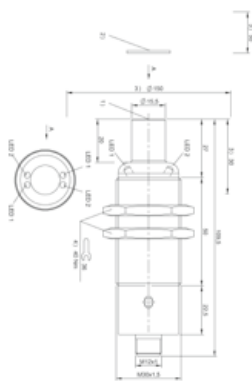
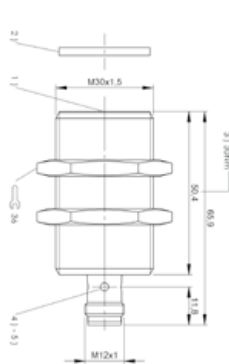
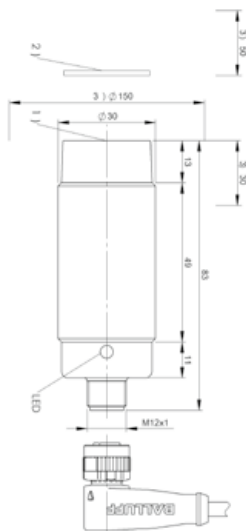

RFID SYSTEM HF (13.56 MHz) BIS M
READ/WRITE HEADS



	BIS00LW BIS M-402-045-002-07-S4	BIS0105 BIS M-402-072-002-07-S4	BIS00M1 BIS M-402-045-004-07-S4	
Product group	HF (13.56 MHz)	HF (13.56 MHz)	HF (13.56 MHz)	
Dimension	Ø 18 x 45.5 mm	Ø 18 x 45.5 mm	25 x 10 x 50 mm	
Installation	with clear zone (in steel)	with clear zone (in steel)	with clear zone (in steel)	
Antenna type	round	round	round	
Connection	M12x1-Male, 4-pole, A-coded	M12x1-Male, 4-pole, A-coded	M12x1-Male, 4-pole, A-coded	
Housing material	Brass, Interface aluminum	Brass, Interface aluminum	ABS, GF16, Interface aluminum	
Interface	IO-Link 1.1	IO-Link 1.0	IO-Link 1.1	
Operating voltage U_b	18...30 VDC Supports only LPS/Class 2	18...30 VDC Supports only LPS/Class 2	18...30 VDC Supports only LPS/Class 2	
Ambient temperature	0...70 °C	0...70 °C	0...70 °C	
IP rating	IP67	IP67	IP67	
Approval/conformity	CE, UL-FILE E227256, Vol. X1, BIS	CE, UL-FILE E227256, Vol. X1, BIS	CE, UL-FILE E227256, Vol. X1, BIS	
Process data	10 byte buffer	32 byte buffer	10 byte buffer	

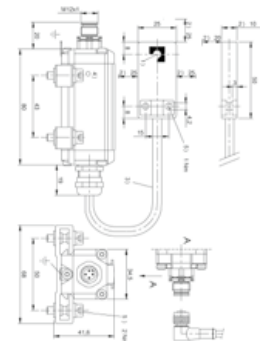
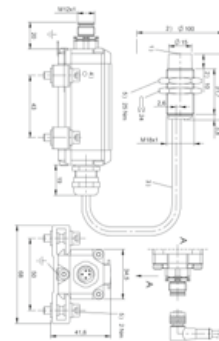
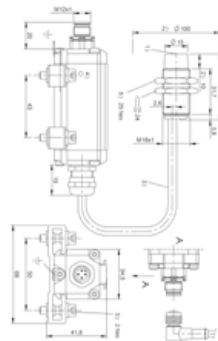

Housing material definitions:
 ABS Acrylonitrile Butadiene Styrene
 GF Glass Fiber



BIS0126 BIS M-402-045-007-07-S4	BIS0106 BIS M-402-072-004-07-S4	BIS012N BIS M-405-045-001-07-S4	BIS0155 BIS M-405-045-008-07-S4	
HF (13.56 MHz)	HF (13.56 MHz)	HF (13.56 MHz)	HF (13.56 MHz)	
25 x 10 x 50 mm	25 x 10 x 50 mm	35 x 17 x 80 mm	35 x 17 x 80 mm	
with clear zone (in steel)	with clear zone (in steel)	with clear zone (in steel)	with clear zone (in steel)	
Rod (metal mount)	round	M18 round	M30 round	
M12x1-Male, 4-pole, A-coded	M12x1-Male, 4-pole, A-coded	M12x1-Male, 4-pole, A-coded	M12x1-Male, 4-pole, A-coded	
ABS, GF16, Interface aluminum	ABS, GF16, Interface aluminum	ABS	ABS	
IO-Link 1.1	IO-Link 1.0	IO-Link 1.1	IO-Link 1.1	
18...30 VDC Supports only LPS/Class 2	18...30 VDC Supports only LPS/Class 2	18...30 VDC Supports only LPS/Class 2	18...30 VDC Supports only LPS/Class 2	
0...70 °C	0...70 °C	0...70 °C	0...70 °C	
IP67	IP67	IP67	IP67	
CE, UL-FILE E227256, Vol. X1, BIS	CE, UL-FILE E227256, Vol. X1, BIS	CE, UL-FILE E227256, Vol. X1, BIS	UL-FILE E227256, Vol. X1, BIS, CE	
10 byte buffer	32 byte buffer	10 byte buffer	10 byte buffer	

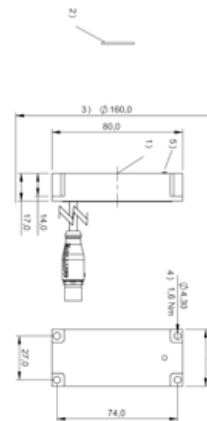
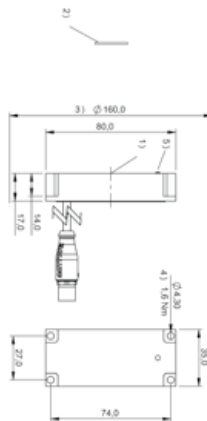
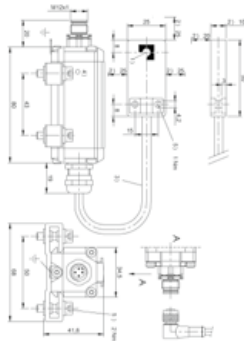
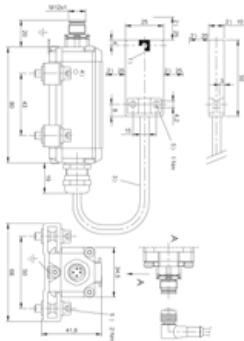

RFID SYSTEM HF (13.56 MHz) BIS M
READ/WRITE HEADS

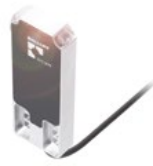

	BIS014J BIS M-408-045-001-07-S4	BIS014K BIS M-458-045-001-07-S4	BIS00LK BIS M-401-045-001-07-S4	
Product group	HF (13.56 MHz)	HF (13.56 MHz)	HF (13.56 MHz)	
Dimension	40 x 15 x 105 mm	40 x 15 x 105 mm	80 x 40 x 84.5 mm	
Installation	with clear zone (in steel)	with clear zone (in steel)	with clear zone (in steel)	
Antenna type	round	Rod (metal mount)	round	
Connection	Male, 4-pole	Male, 4-pole	M12x1-Male, 4-pole, A-coded	
Housing material	Die-cast zinc	Die-cast zinc	PBT	
Interface	IO-Link 1.1	IO-Link 1.1	IO-Link 1.1	
Operating voltage U_b	18...30 VDC Supports only LPS/Class 2	18...30 VDC Supports only LPS/Class 2	18...30 VDC Supports only LPS/Class 2	
Ambient temperature	0...70 °C	0...70 °C	0...70 °C	
IP rating	IP67	IP67	IP67	
Approval/conformity	CE	CE	CE, UL-FILE E227256, Vol. X1, BIS	
Process data	10 byte buffer	10 byte buffer	10 byte buffer	

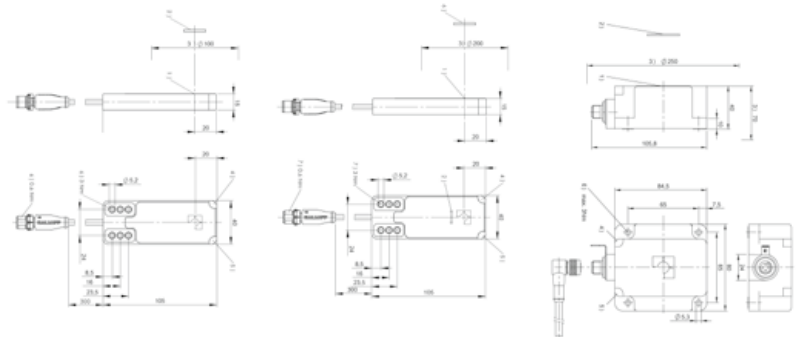

Housing material definitions:
PBT Polybuteneterephthalate

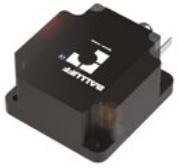

BIS00LM BIS M-451-045-001-07-S4	BIS0102 BIS M-401-072-001-07-S4	BIS0103 BIS M-451-072-001-07-S4		
HF (13.56 MHz)	HF (13.56 MHz)	HF (13.56 MHz)		
80 x 40 x 84.5 mm	80 x 40 x 84.5 mm	80 x 40 x 84.5 mm		
with clear zone (in steel)	with clear zone (in steel)	with clear zone (in steel)		
Rod (metal mount)	round	Rod (metal mount)		
M12x1-Male, 4-pole, A-coded	M12x1-Male, 4-pole, A-coded	M12x1-Male, 4-pole, A-coded		
PBT	PBT	PBT		
IO-Link 1.1	IO-Link 1.1	IO-Link 1.0		
18...30 VDC Supports only LPS/Class 2	18...30 VDC Supports only LPS/Class 2	18...30 VDC Supports only LPS/Class 2		
0...70 °C	0...70 °C	0...70 °C		
IP67	IP67	IP67		
UL-FILE E227256, Vol.X1, BIS, CE	CE, UL-FILE E227256, Vol. X1, BIS	CE, UL-FILE E227256, Vol. X1, BIS		
10 byte buffer	32 byte buffer	32 byte buffer		

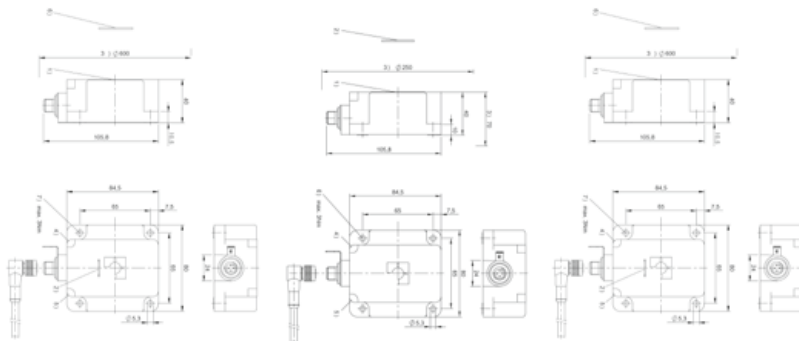

RFID SYSTEM LF (125 kHz) BIS L
READ/WRITE HEADS



	BIS00C7 BIS L-409-045-001-07-S4	BIS00E0 BIS L-409-045-002-07-S4	BIS00E1 BIS L-409-045-003-07-S4
Product group	LF (125 kHz)	LF (125 kHz)	LF (125 kHz)
Dimension	40 x 41 x 120 mm	Ø 18 x 75 mm	Ø 12 x 53 mm
Installation	with clear zone (in steel)	with clear zone (in steel)	with clear zone (in steel)
Antenna type	round	round	round
Connection	M12x1-Male, 4-pole, A-coded	M12x1-Male, 4-pole, A-coded	M12x1-Male, 4-pole, A-coded
Housing material	PBT	Brass, Interface PBT	Brass, Interface PBT
Interface	IO-Link 1.0	IO-Link 1.0	IO-Link 1.0
Operating voltage U_b	18...30 VDC	18...30 VDC	18...30 VDC
Ambient temperature	0...70 °C	0...70 °C	0...70 °C
IP rating	IP67	IP67	IP67
Approval/conformity	CE, UL-FILE E227256, Vol. X1, BIS	CE, UL-FILE E227256, Vol. X1, BIS	CE, UL-FILE E227256, Vol. X1, BIS

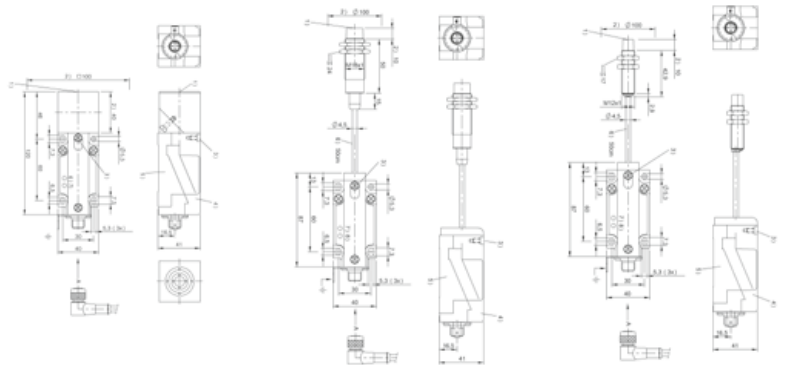

Housing material definitions:
PBT Polybuteneterephthalate



BIS00E2 BIS L-409-045-004-07-S4				
LF (125 kHz)				
25 x 10 x 50 mm				
with clear zone (in steel)				
round				
M12x1-Male, 4-pole, A-coded				
ABS, Interface PBT				
IO-Link 1.0				
18...30 VDC				
0...70 °C				
IP67				
CE, UL-FILE E227256, Vol. X1, BIS				

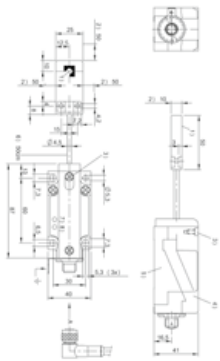

RFID SYSTEM LF (125 kHz) BISV
IO-LINK MASTER



	BIS00T3 BIS V-6102-019-C001	BIS012E BIS V-6102-019-C101	BIS012F BIS V-6106-034-C002	
Product group	Multi-Frequency	Multi-Frequency	Multi-Frequency	
Interface	Profibus	Profibus	EtherNet/IP	
Operating voltage U_b	24 V DC LPS Class 2	24 V DC LPS Class 2	24 V DC LPS Class 2	
Housing material	Die-cast zinc	Die-cast zinc	Die-cast zinc	
Ambient temperature	0...60 °C	0...60 °C	0...60 °C	
IP rating	IP65 with connector	IP65 with connector	IP65 with connector	
Approval/conformity	CE, UL-FILE E227256, Vol. X1, BIS	CE, EN 300 330-2, UL-FILE E227256, Vol.X1, BIS	CE, UL-FILE E227256, Vol. X1, BIS	
Auxiliary interfaces	1x IO Link	1x IO Link	1x IO Link	
Port class	Type A	Type A	Type A	

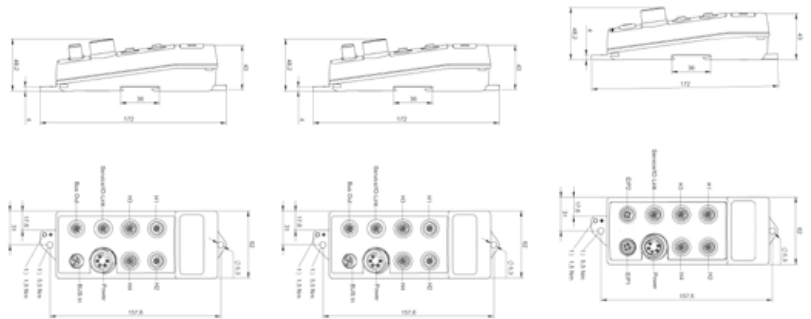



BIS0122 BIS V-6106-034-C004	BIS014C BIS V-6106-034-C102	BIS0146 BIS V-6106-034-C104	BIS013U BIS V-6108-048-C002	BIS013W BIS V-6108-048-C102
Multi-Frequency	Multi-Frequency	Multi-Frequency	Multi-Frequency	Multi-Frequency
EtherNet/IP	EtherNet/IP	EtherNet/IP	Profinet	Profinet
24 V DC LPS Class 2	24 V DC LPS Class 2	24 V DC LPS Class 2	24 V DC LPS Class 2	24 V DC LPS Class 2
Die-cast zinc	Die-cast zinc	Die-cast zinc	Die-cast zinc	Die-cast zinc
0...60 °C	0...60 °C	0...60 °C	0...60 °C	0...60 °C
IP65 with connector	IP65 with connector	IP65 with connector	IP65 with connector	IP65 with connector
CE, UL-FILE E227256, Vol. X1, BIS	CE, EN 300 330-2, UL-FILE E227256, Vol.X1, BIS	CE, EN 300 330-2, UL-FILE E227256, Vol.X1, BIS	CE, UL-FILE E227256, Vol. X1, BIS	CE, EN 300 330-2, UL-FILE E227256, Vol.X1, BIS
1x IO Link	1x IO Link	1x IO Link	1x IO Link	1x IO Link
Type A	Type A	Type A	Type A	Type A

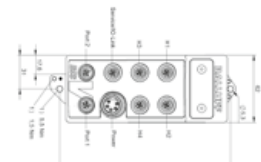
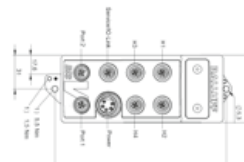
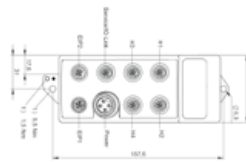
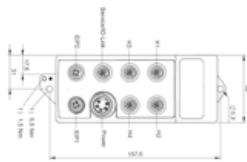
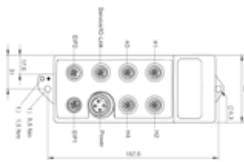
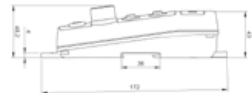
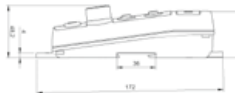
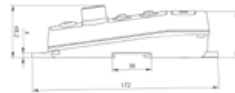
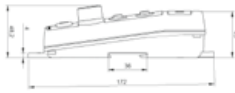
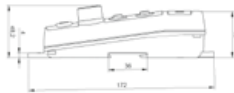



BIS014E BIS V-6111-073-C103				
Multi-Frequency				
CC-Link				
24 V DC LPS Class 2				
Die-cast zinc				
0...60 °C				
IP65 with connector				
CE, EN 300 330-2, UL- FILE E227256, Vol.X1, BIS				
1x IO Link				
Type A				

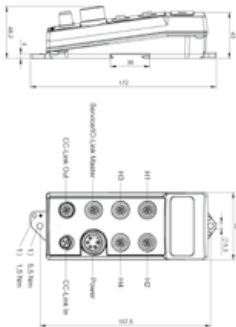



Image processing devices for reliable detection and recording

MACHINE VISION AND OPTICAL IDENTIFICATION

 *innovating automation*



The demands on modern production equipment are high: they must be extremely productive and flexible while achieving maximum quality. Our Balluff Vision Solutions are designed precisely to meet these requirements. They reliably detect error, check the quality and are suitable for reading and verification of codes. They scan objects, 1D and 2D barcodes and plain text.

The sensors are extremely flexible, an asset for parts checking in assembly or parts tracking in production. Their standardized interface makes devices simple to integrate and easy to use.

Your Balluff solution

- SmartCamera IO-Link master



SMARTCAMERA IO-LINK MASTER

	BVS002A BVS SC-M1280Z00-30-000		
1D codes	GS1 Databar, GS1-128, UPC-A, UPC-E, EAN-8, EAN-13, 2/5 Industrial, 2/5 Interleaved, Codabar, Code 128, Code 39, Code 93, MSI, UPC-A, UPC-E		
2D codes	Aztec Code, Data Matrix ECC 200, GS1 Aztec Code, GS1 Data Matrix, GS1 QR Code, Micro QR Code, PDF 417, QR code		
Application	Object inspection, Range, Object detection, Positioning, Barcode-, 2D-, OCR identification		
Image resolution	1280 x 1024 pixels		
Sensor type Vision	CMOS 1/1.8"9 monochrome global shutter		
Housing material	Aluminum		
Dimension	62 x 55 x 110 mm		
Switching output	2x IO configurable		
Interface	LAN (Gigabit Ethernet) Profinet / EtherNet/IP 1x IO-Link Master		
Operating voltage Ub	19.2...28.8 VDC		
Ambient temperature	0...55 °C		
Approval/conformity	CE, UL-FILE E227256, Vol.X1, BIS		
IP rating	IP67 with protection tube		

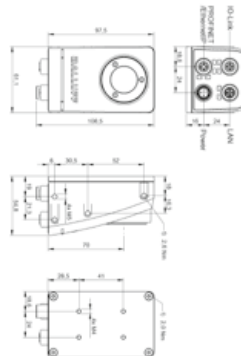

Safety with Balluff quality

SAFETY



innovating automation

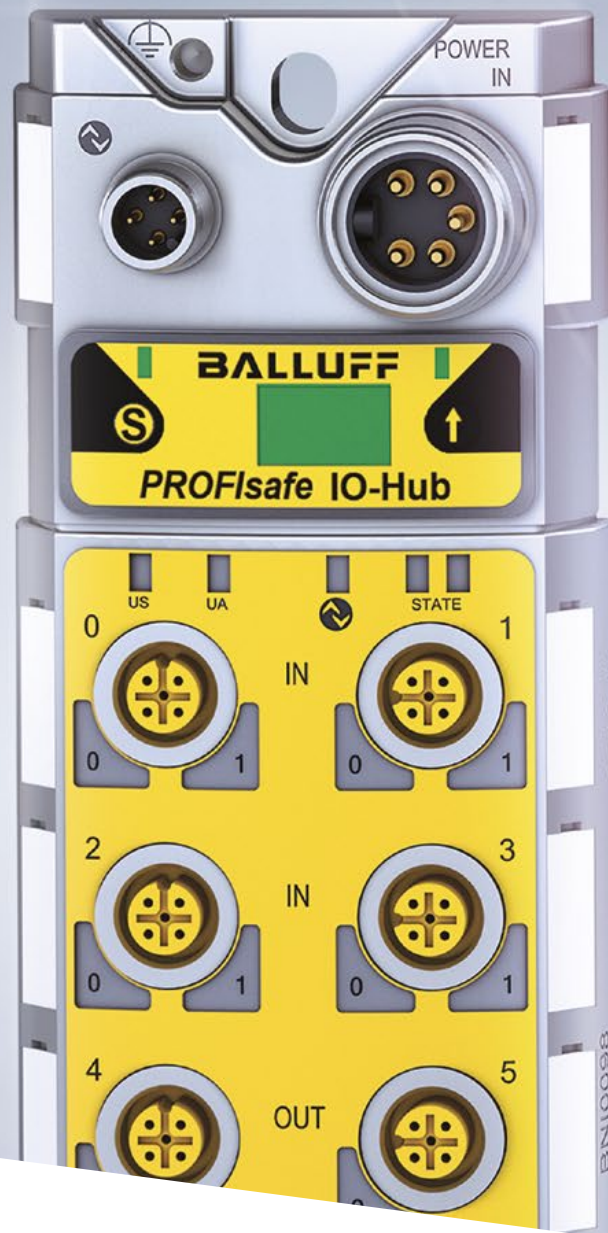

Automation requires safety. And safety is based on reliability. The Balluff safety concept consists of products and solutions that fulfill their tasks over the course of years with consistent reliability and precision. With Safety over IO-Link from Balluff you enjoy the proven benefits of IO-Link plus the safety of your people and equipment. By linking automation and safety technology, you achieve full machine security in one system.

Your Balluff solutions

- Safety I/O modules



SAFETY I/O MODULES

	BNI0033 BNI IOL-252-000-Z013	BNI003W BNI IOL-252-S01-Z013	BNI0034 BNI IOL-256-000-Z013	
Principle of operation	IO-Link master	IO-Link master	IO-Link master	
Dimension	68 x 32.4 x 181.5 mm	68 x 32.4 x 181.5 mm	68 x 32.4 x 181.5 mm	
Housing material	Die-cast zinc	Die-cast zinc	Die-cast zinc	
Connection slots	8x M12x1-Female, 5-pole, A-coded	8x M12x1-Female, 5-pole, A-coded	8x M12x1-Female, 5-pole, A-coded	
Digital inputs	0	0	0	
Digital outputs	8x PNP	8x PNP	16x PNP	
Operating voltage Ub	18...30.2 VDC	18...30.2 VDC	18...30.2 VDC	
Output current max.	2 A	2 A	2 A	
Auxiliary interfaces	Galvanically Isolated Outputs	Galvanically Isolated Outputs	Galvanically Isolated Outputs	
Interface	IO-Link 1.0	IO-Link 1.0	IO-Link 1.0	
Ambient temperature	-5...70 °C	-5...70 °C	-5...70 °C	
IP rating	IP67	IP67	IP67	
SIL (IEC 61508)	no	no	no	
SIL CL (EN 62061)	no	no	no	
PFHd (EN 62061)	no	no	no	

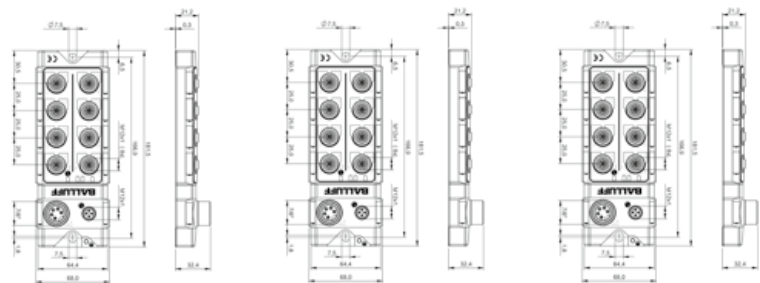



BNI003Y BNI IOL-256-S01-Z013	BNI00CL BNI IOL-355-S02-Z013			
IO-Link master	IO-Link master			
68 x 32.4 x 181.5 mm	68 x 32.4 x 181.5 mm			
Die-cast zinc	Die-cast zinc			
8x M12x1-Female, 5-pole, A-coded	8x M12x1-Female, 5-pole, A-coded			
0	8x PNP, Type 3			
16x PNP	8x PNP			
18...30.2 VDC	18...30.2 VDC			
2 A	2 A			
Galvanically Isolated Outputs	Galvanically Isolated Outputs			
IO-Link 1.0	IO-Link 1.1			
-5...70 °C	-5...55 °C			
IP67	IP67			
no	2			
no	2			
no	12.5 E-9 1/h			

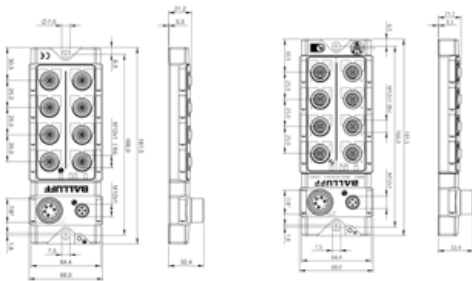



PROFISAFE OVER IO-LINK MODULE

	BNI0098 BNI IOF-329-P02-Z038		
Principle of operation	IO-Link master		
Dimension	68 x 32.4 x 181.5 mm		
Housing material	Die-cast zinc		
Connection slots	2x M12x1-Female, 8-pole, A-coded 6x M12x1-Female, 5-pole, A-coded		
Number of safe inputs	12		
Number of safe outputs	2		
Digital inputs	6x PNP, Type3		
Operating voltage U_b	19.2...30 VDC		
Output current max.	2A/output		
Interface	PROFIsafe over IO-Link		
Ambient temperature	-5...55 °C		
IP rating	IP67		
SIL (IEC 61508)	3		
SIL CL (EN 62061)	3		
PFHd (EN 62061)	9 E-9 1/h		

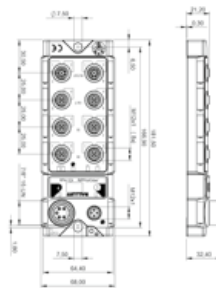



Reliable information exchange across all levels

INDUSTRIAL NETWORKING



innovating automation

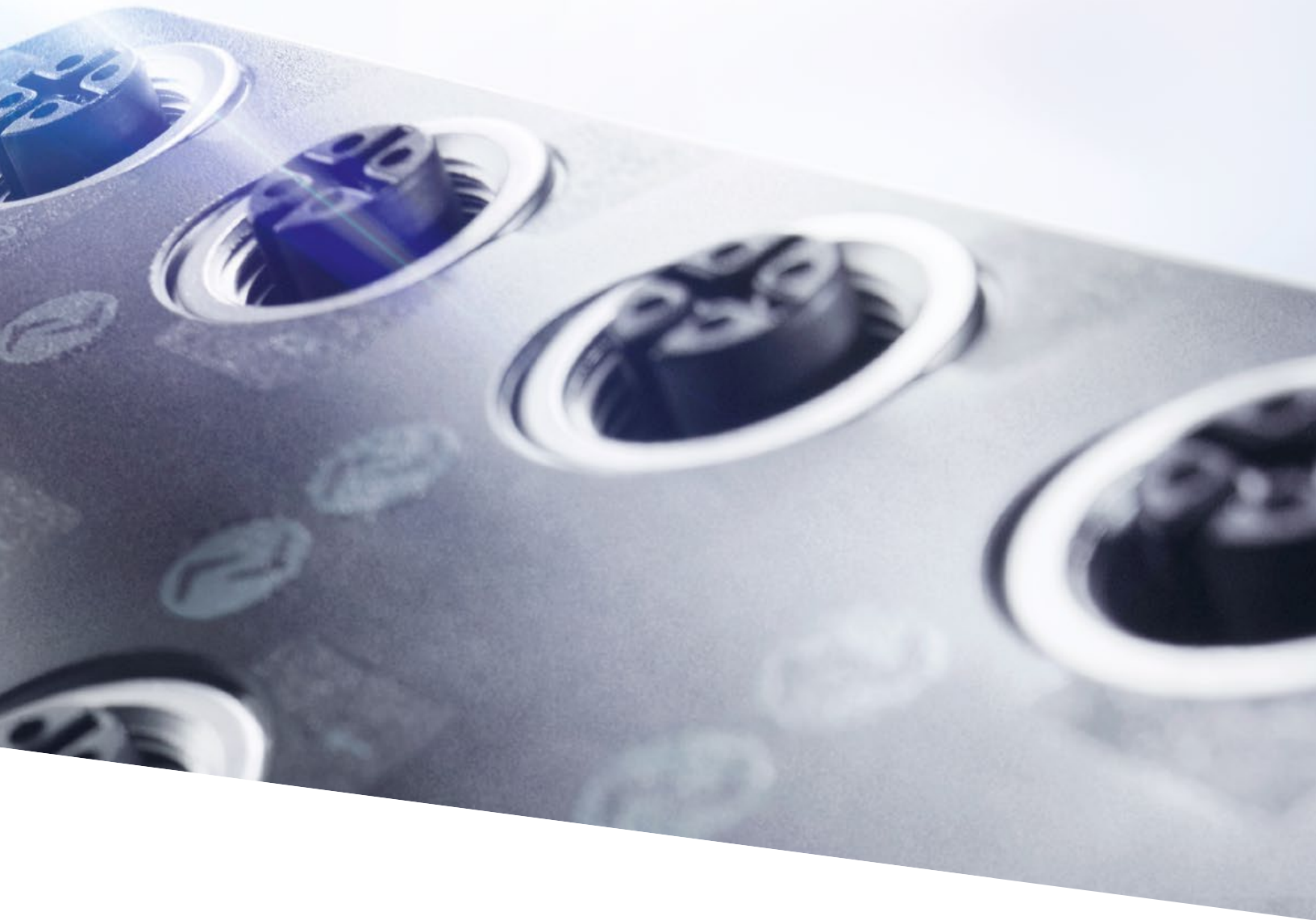

The demands on industrial networking continually increase. The rising quantities of data and increasingly complex communication require high-performance components that can reliably transport the information across all levels. This is especially true if high protection ratings, robustness, use at high temperatures or special interfaces, and connections for maximum security are needed.

With an intelligent combination of high-performance industrial networking technology and the IO-Link communication standard, Balluff makes flexible and smooth communication possible in a vast variety of applications.

Your Balluff solutions

- IO-Link master blocks
- Discrete I/O hubs
- Valve interfaces
- Universal discrete I/O
- Analog I/O
- Signal converters
- Memory module
- Inductive couplers



IO-LINK MASTER BLOCKS
ETHERNET/IP

	BNI006A BNI EIP-508-105-Z015	BNI007C BNI EIP-508-105-Z015-C06	BNI008M BNI EIP-508-105-R015	
Principle of operation	IO-Link master	IO-Link master	IO-Link master	
Dimension	68 x 37.9 x 224 mm	68 x 37.9 x 224 mm	68 x 42.9 x 226 mm	
Housing material	Die-cast zinc	Die-cast zinc	PPS	
Interface	EtherNet/IP	EtherNet/IP	EtherNet/IP	
Digital inputs	16x PNP, Type2	16x PNP, Type2	16x PNP, Type2	
Digital outputs	16x PNP	16x PNP	16x PNP	
Configurable inputs/outputs	yes	yes	yes	
Auxiliary interfaces	8x IO-Link	8x IO-Link	8x IO-Link	
Port-class	Type A	Type A	Type A	
Connection slots	8x M12x1 Female, 5-pole, A-coded	8x M12x1 Female, 5-pole, A-coded	8x M12x1 Female, 5-pole, A-coded	
Operating voltage U_b	18...30.2 VDC	18...30.2 VDC	18...30.2 VDC	
Output current max.	2 A	2 A	2 A	
Current sum I_A , actuator	9.0 A	9.0 A	9.0 A	
Address range	IPV4	IPV4	IPV4	
Ambient temperature	-5...70 °C	-5...55 °C	-5...50 °C	
IP rating	IP67	IP67	IP67	

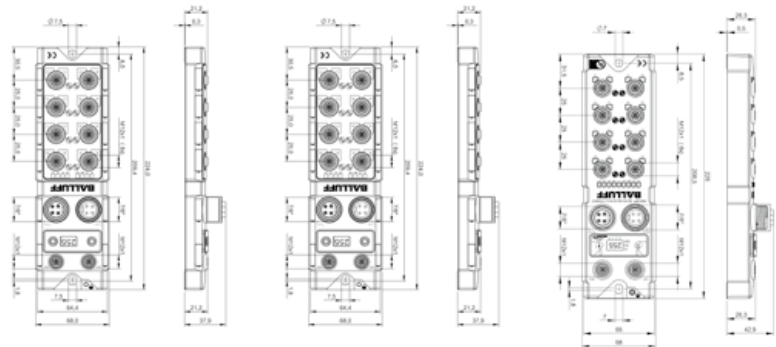

Housing material definitions:
PPS Polyphenylene Sulfide



BNI0079 BNI EIP-508-105-Z015-C05	BNI004A BNI EIP-502-105-Z015	BNI0078 BNI EIP-502-105-Z015-C05	BNI008Z BNI EIP-502-105-R015	BNI009T BNI EIP-507-005-Z040
IO-Link master	IO-Link master	IO-Link master	IO-Link master	IO-Link master
68 x 37.9 x 220 mm	68 x 37.9 x 224 mm	68 x 37.9 x 224 mm	68 x 42.9 x 226 mm	37 x 32.6 x 224 mm
Die-cast zinc	Die-cast zinc	Die-cast zinc	PPS	Die-cast zinc
EtherNet/IP	EtherNet/IP	EtherNet/IP	EtherNet/IP	EtherNet/IP
16x PNP, Type2	16x PNP, Type2	16x PNP, Type2	16x PNP, Type2	8x PNP, Type2
16x PNP	16x PNP	16x PNP	16x PNP	8x PNP
yes	yes	yes	yes	yes
8x IO-Link	4x IO-Link	4x IO-Link	4x IO-Link	4x IO-Link
Type A	Type A	Type A	Type A	Type A
8x M12x1 Female, 5-pole, A-coded	8x M12x1 Female, 5-pole, A-coded	8x M12x1 Female, 5-pole, A-coded	8x M12x1 Female, 5-pole, A-coded	4x M12x1 Female, 5-pole, A-coded
18...30.2 VDC	18...30.2 VDC	18...30.2 VDC	18...30.2 VDC	18...30.2 VDC
2 A	2 A	2 A	2 A	2 A
9.0 A	9.0 A	9.0 A	9.0 A	9.0 A
IPV4	IPV4	IPV4	IPV4	IPV4
-5...55 °C	-5...55 °C	-5...55 °C	-5...50 °C	-5...55 °C
IP67	IP67	IP67	IP67	IP67

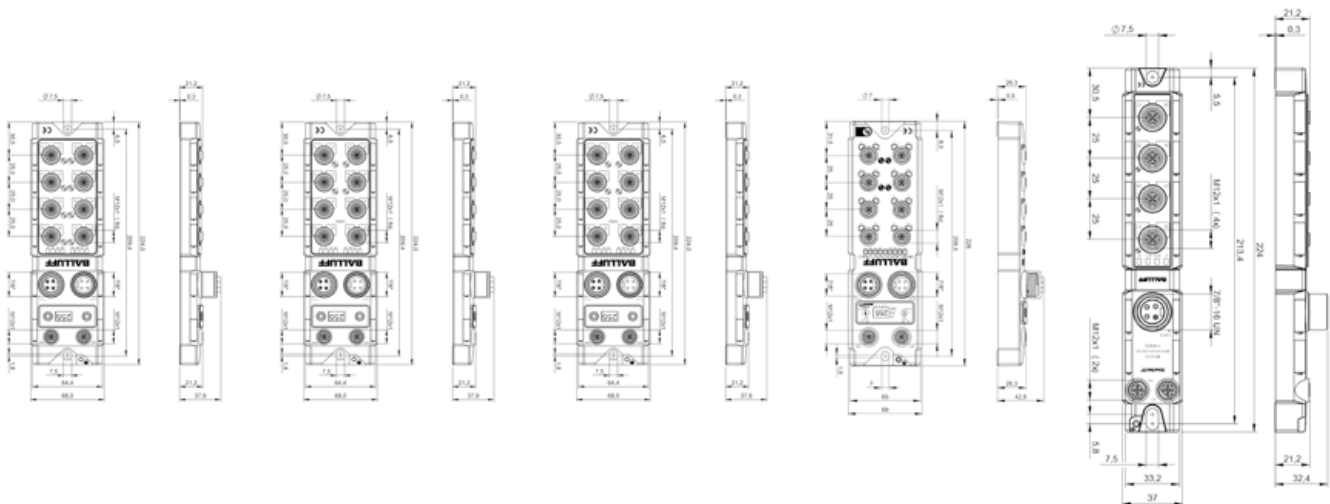



IO-LINK MASTER BLOCKS
ETHERNET/IP

	BNI00AA BNI EIP-527-005-Z040	BNI0096 BNI EIP-508-005-E002	BNI00CE BNI EIP-508-105-R015-007	
Principle of operation	IO-Link master	IO-Link master	IO-Link master	
Dimension	37 x 32.6 x 224 mm	70 x 44.1 x 228 mm	68 x 42.9 x 226 mm	
Housing material	Die-cast zinc	Stainless steel (1.4571)	PPS	
Interface	EtherNet/IP	EtherNet/IP	EtherNet/IP	
Digital inputs	8x PNP, Type2	16x PNP, Type3	16x PNP, Type2	
Digital outputs	8x PNP	8x PNP	8x PNP	
Configurable inputs/outputs	yes	yes	yes	
Auxiliary interfaces	4x IO-Link	8x IO-Link	8x IO-Link	
Port-class	Type B	Type A	Type A	
Connection slots	4x M12 Female, 5-pole, A-coded	8x M12 Female, 5-pole, A-coded	8x M12 Female, 5-pole, A-coded	
Operating voltage U_b	18...30.2 VDC	18...30.2 VDC	18...30.2 VDC	
Output current max.	2 A	2 A	2 A	
Current sum I_{UA} , actuator	9.0 A	9.0 A	9.0 A	
Address range	IPV4	IPV4	IPV4	
Ambient temperature	-5...55 °C	-5...70 °C	-5...50 °C	
IP rating	IP67	IP69	IP67	

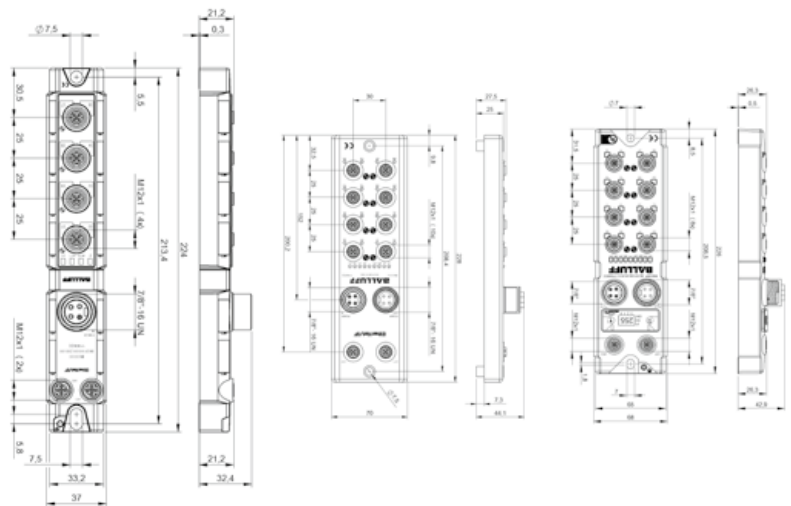

Housing material definitions:
PPS Polyphenylene Sulfide



IO-LINK MASTER BLOCKS
PROFINET

	BNI007M BNI PNT-509-105-Z033	BNI005H BNI PNT-508-105-Z015	BNI009M BNI PNT-508-005-E002	
Principle of operation	IO-Link master	IO-Link master	IO-Link master	
Dimension	68 x 37.9 x 334 mm	68 x 37.9 x 224 mm	70 x 44.1 x 228 mm	
Housing material	Die-cast zinc	Die-cast zinc	Stainless steel (1.4571)	
Interface	Profinet I/O	Profinet I/O	Profinet I/O	
Digital inputs	32x PNP, Type 3	16x PNP, Type3	16x PNP, Type3	
Digital outputs	32x PNP	16x PNP	16x PNP	
Configurable inputs/outputs	yes	yes	yes	
Auxiliary interfaces	16x IO-Link	8x IO-Link	8x IO-Link	
Port-class	Type A	Type A	Type A	
Connection slots	16x M12x1-Female, 5-pole, A-coded	8x M12x1-Female, 5-pole, A-coded	8x M12x1-Female, 5-pole, A-coded	
Operating voltage U_b	18...30.2 VDC	18...30.2 VDC	18...30.2 VDC	
Output current max.	2 A	2 A	2 A	
Current sum U_A , actuator	9.0 A	9.0 A	9.0 A	
Address range	IPV4	IPV4	IPV4	
Ambient temperature	-5...70 °C	-5...70 °C	-5...55 °C	
IP rating	IP67	IP67	IP69	

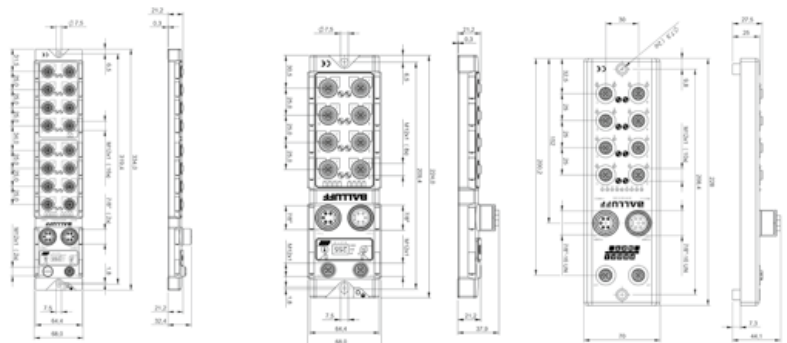

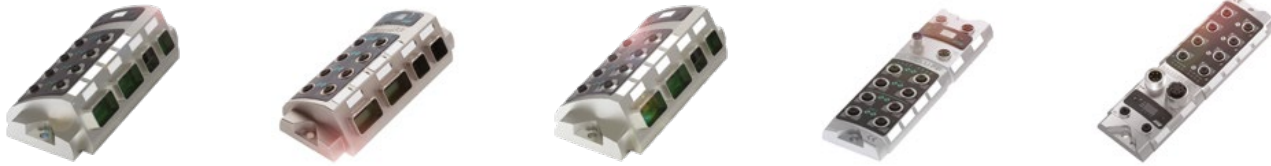

BNI007K BNI PNT-508-105-Z031	BNI007J BNI PNT-508-105-Z031-002	BNI007Y BNI PNT-508-105-Z031-004	BNI00A7 BNI PNT-538-105-Z063	BNI006C BNI PNT-502-102-Z015
IO-Link master	IO-Link master	IO-Link master	IO-Link master	IO-Link master
84.4 x 47 x 185.4 mm	84.4 x 47 x 185.4 mm	84.4 x 47 x 185.4 mm	68 x 37.9 x 224 mm	68 x 37.9 x 224 mm
Die-cast zinc	Die-cast zinc	Die-cast zinc	Die-cast zinc	Die-cast zinc
Profinet I/O, AIDA Push/Pull connectors, RJ45	Profinet I/O, AIDA Push/Pull connectors Fiber optic	Profinet I/O, AIDA Push/Pull connectors, RJ45, Fiber optic	Profinet I/O	Profinet I/O
16x PNP, Type2	16x PNP, Type2	16x PNP, Type2	8x PNP, Type3	16x PNP, Type3
16x PNP	16x PNP	16x PNP	8x PNP	16x PNP
yes	yes	yes	yes	yes
8x IO-Link	8x IO-Link	8x IO-Link	8x IO-Link	4x IO-Link
Type A	Type A	Type A	Type A (4x) + Type B (4x)	Type A
8x M12x1-Female, 5-pole, A-coded	8x M12x1-Female, 5-pole, A-coded	8x M12x1-Female, 5-pole, A-coded	8x M12x1-Female, 5-pole, A-coded	8x M12x1-Female, 5-pole, A-coded
18...30.2 VDC	18...30.2 VDC	18...30.2 VDC	18...30.2 VDC	18...30.2 VDC
2 A	2 A	2 A	2 A	2 A
16.0 A	16.0 A	16.0 A	9.0 A	9.0 A
IPV4	IPV4	IPV4	IPV4	IPV4
-5...70 °C	-5...55 °C	-5...70 °C	-5...70 °C	-5...70 °C
IP67	IP67	IP67	IP67	IP67

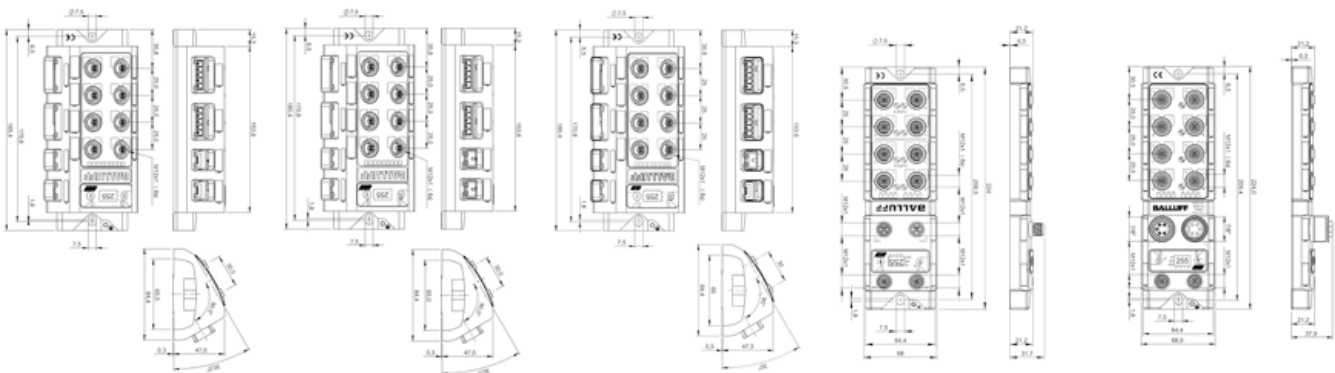



IO-LINK MASTER BLOCKS
PROFINET

	BNI004U BNI PNT-502-105-Z015	BNI0092 BNI PNT-507-005-Z040	BNI00A9 BNI PNT-527-005-Z040	
Principle of operation	IO-Link master	IO-Link master	IO-Link master	
Dimension	68 x 37.9 x 224 mm	37 x 32.6 x 224 mm	37 x 32.6 x 224 mm	
Housing material	Die-cast zinc	Die-cast zinc	Die-cast zinc	
Interface	Profinet I/O	Profinet I/O	Profinet I/O	
Digital inputs	16x PNP, Type3	8x PNP, Type2	8x PNP, Type2	
Digital outputs	16x PNP	8x PNP	8x PNP	
Configurable inputs/outputs	yes	yes	yes	
Auxiliary interfaces	4x IO-Link	4x IO-Link	4x IO-Link	
Port-class	Type A	Type A	Type B	
Connection slots	8x M12 Female, 5-pole, A-coded	4x M12 Female, 5-pole, A-coded	4x M12 Female, 5-pole, A-coded	
Operating voltage U_b	18...30.2 VDC	18...30.2 VDC	18...30.2 VDC	
Output current max.	2 A	2 A	2 A	
Current sum I_{UA} , actuator	9.0 A	9.0 A	9.0 A	
Address range	IPV4	IPV4	IPV4	
Ambient temperature	-5...70 °C	-5...70 °C	-5...70 °C	
IP rating	IP67	IP67	IP67	

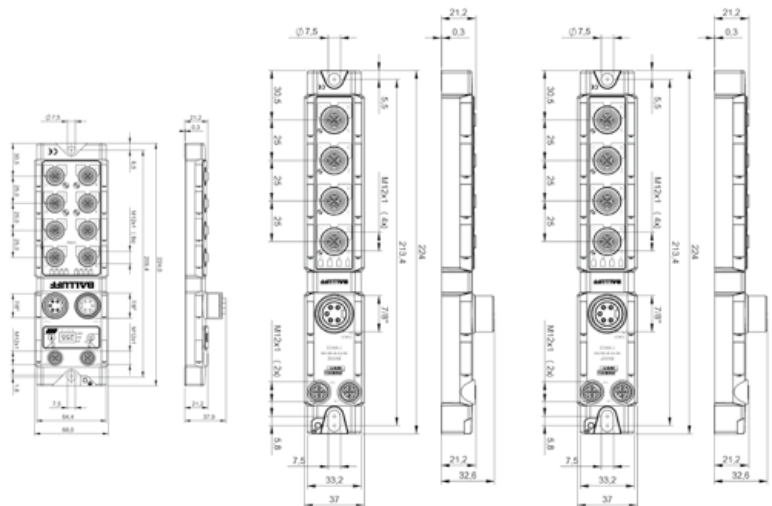



IO-LINK MASTER BLOCKS
ETHERCAT

	BNI0077 BNI ECT-508-105-Z015	BNI009U BNI ECT-507-005-Z040	BNI00AC BNI ECT-527-005-Z040
Principle of operation	IO-Link master	IO-Link master	IO-Link master
Dimension	68 x 37.9 x 224 mm	37 x 32.6 x 224 mm	37 x 32.6 x 224 mm
Housing material	Die-cast zinc	Die-cast zinc	Die-cast zinc
Interface	EtherCAT	EtherCAT	EtherCAT
Digital inputs	16x PNP, Type2	8x PNP, Type2	8x PNP, Type2
Digital outputs	16x PNP	8x PNP	8x PNP
Configurable inputs/outputs	yes	yes	yes
Auxiliary interfaces	8x IO-Link	4x IO-Link	4x IO-Link
Port-class	Type A	Type A	Type B
Connection slots	8x M12 Female, 5-pole, A-coded	4x M12 Female, 5-pole, A-coded	4x M12 Female, 5-pole, A-coded
Operating voltage U_b	18...30.2 VDC	18...30.2 VDC	18...30.2 VDC
Output current max.	2 A	2 A	2 A
Current sum I_{UA} , actuator	9.0 A	9.0 A	9.0 A
Ambient temperature	-5...70 °C	-5...70 °C	-5...70 °C
IP rating	IP67	IP67	IP67

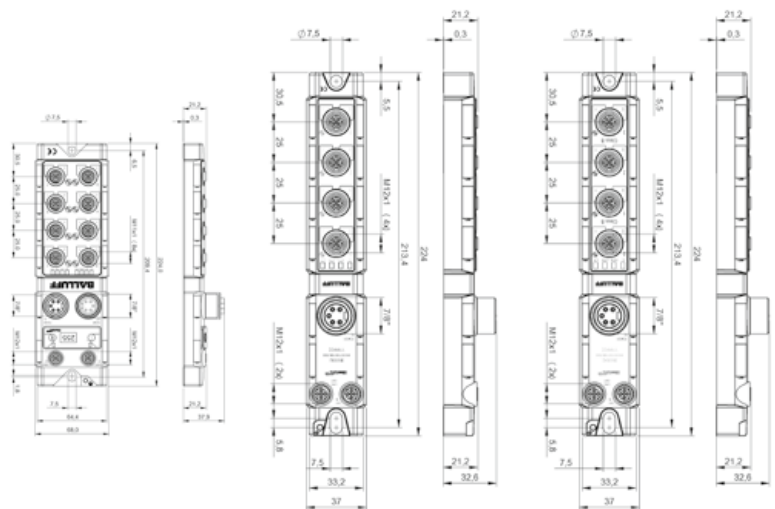



IO-LINK MASTER BLOCK
CC-LINK IE/FIELD

	BNIO08C BNI CIE-508-105-Z015		
Principle of operation	IO-Link master		
Dimension	68 x 37.9 x 224 mm		
Housing material	Die-cast zinc		
Interface	CC-Link IE Field CC-Link IE Field V0		
Digital inputs	16x PNP, Type3		
Digital outputs	16x PNP		
Configurable inputs/outputs	yes		
Auxiliary interfaces	8x IO-Link		
Port-class	Type A		
Connection slots	8x M12 Female, 5-pole, A-coded		
Operating voltage U_b	18...30.2 VDC		
Output current max.	2 A		
Current sum U_A , actuator	9.0 A		
Address range	0 - 120		
Ambient temperature	-5...70° C		
IP rating	IP67		

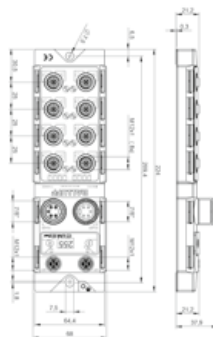



IO-LINK MASTER BLOCK
DEVICENET

	BNI005A BNI DNT-502-100-Z001			
Principle of operation	IO-Link master			
Dimension	68 x 37.9 x 224 mm			
Housing material	Die-cast zinc			
Interface	DeviceNet			
Digital inputs	16x PNP, Type2			
Digital outputs	16x PNP			
Configurable inputs/outputs	yes			
Auxiliary interfaces	4x IO-Link			
Port-class	Type A			
Connection slots	8x M12x1 Female, 5-pole, A-coded			
Operating voltage U_b	18...30.2 VDC			
Output current max.	350 mA			
Current sum I_A , actuator	1.6 A			
Address range	0 - 63			
Ambient temperature	-5...70 °C			
IP rating	IP67			

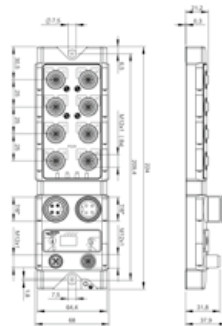



IO-LINK MASTER BLOCKS
PROFIBUS

	BNI003K BNI PBS-502-001-Z001	BNI005R BNI PBS-502-101-Z001	BNI003P BNI PBS-507-001-Z011	
Principle of operation	IO-Link master	IO-Link master	IO-Link master	
Dimension	68 x 37.9 x 224 mm	68 x 37.9 x 224 mm	37 x 32.4 x 224 mm	
Housing material	Die-cast zinc	Die-cast zinc	Die-cast zinc	
Interface	Profibus DP	Profibus DP	Profibus DP	
Digital inputs	16x PNP, Type2	16x PNP, Type2	8x PNP, Type2	
Digital outputs	16x PNP	16x PNP	8x PNP	
Configurable inputs/outputs	yes	yes	yes	
Auxiliary interfaces	4x IO-Link	4x IO-Link	4x IO-Link	
Port-class	Type A	Type A	Type A	
Connection slots	8x M12x1-Female, 5-pole, A-coded	8x M12x1-Female, 5-pole, A-coded	4x M12x1-Female, 5-pole, A-coded	
Operating voltage U_b	18...30.2 VDC	18...30.2 VDC	18...30.2 VDC	
Output current max.	2 A	2 A	2 A	
Current sum I_{UA} , actuator	9.0 A	9.0 A	9.0 A	
Address range	0 - 99	0 - 126	0 - 99	
Ambient temperature	-5...70 °C	-5...70 °C	-5...70 °C	
IP rating	IP67	IP67	IP67	

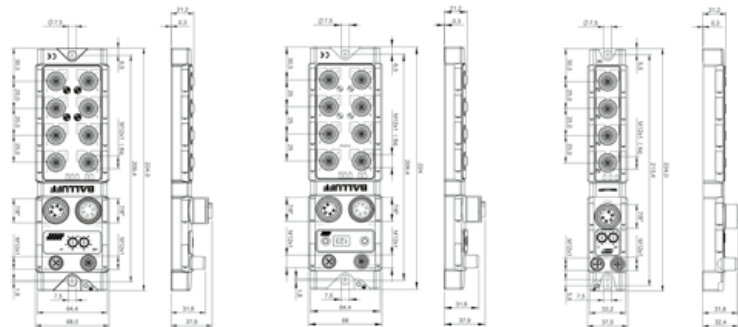

Housing material definitions:
ABS Acrylonitrile Butadiene Styrene



BNI004N BNI PBS-507-002-Z011	BNI0030 BNI PBS-504-001-K008	BNI004P BNI PBS-504-002-K008		
IO-Link master	IO-Link master	IO-Link master		
37 x 32.5 x 22.5 mm	75.8 x 10 x 150.8 mm	75.8 x 10 x 150.8 mm		
Die-cast zinc	ABS	ABS		
Profibus DP	Profibus DP	Profibus DP		
8x PNP, Type2	4x PNP, Type2	4x PNP, Type2		
8x PNP	4x PNP	4x PNP		
yes	yes	yes		
4x IO-Link	4x IO-Link	4x IO-Link 1.1		
Type A	Type A	Type A		
4x M12x1-Female, 5-pole, A-coded	4x M12x1 Female, 5-pole, A-coded	4x M12x1 Female, 5-pole, A-coded		
18...30.2 VDC	18...30.2 VDC	18...30.2 VDC		
2 A	2 A	2 A		
9.0 A	12 A	12 A		
0 - 99	0 - 99	0 - 99		
-5...70 °C	-5...55 °C	-5...55 °C		
IP67	IP54	IP54		

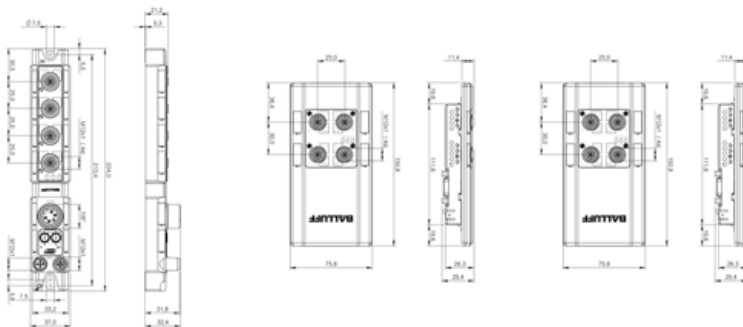



IO-LINK MASTER BLOCK
CC-LINK

	BNI0040 BNI CCL-502-100-Z001			
Principle of operation	IO-Link master			
Dimension	68 x 37.9 x 224 mm			
Housing material	Die-cast zinc			
Interface	CC-Link CC-Link V1.1			
Digital inputs	16x PNP, Type2			
Digital outputs	16x PNP			
Configurable inputs/outputs	yes			
Auxiliary interfaces	4x IO-Link			
Port-class	Type A			
Connection slots	8x M12 Female, 5-pole, A-coded			
Operating voltage U_b	18...30.2 VDC			
Output current max.	2 A			
Current sum U_A , actuator	9.0 A			
Address range	1 - 64			
Ambient temperature	-5...55 °C			
IP rating	IP67			

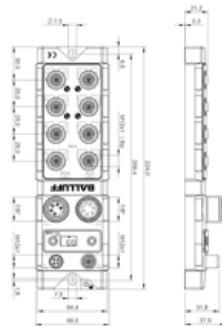



DISCRETE I/O HUBS

	BNI IOAP BNI IO-L-104-002-E012	BNI IOAR BNI IO-L-302-002-E012	BNI IOAT BNI IO-L-302-002-E013	
Dimension	70 x 37.9 x 185.6 mm	70 x 37.9 x 185.6 mm	70 x 38.4 x 185.6 mm	
Housing material	Stainless steel (1.4571)	Stainless steel (1.4571)	Stainless steel (1.4571)	
Interface	IO-Link 1.1	IO-Link 1.1	IO-Link 1.1	
Analog inputs	none	none	none	
Digital inputs	16x PNP, Type3	16x PNP, Type3	16x PNP, Type3	
Digital outputs	none	16x PNP	16x PNP	
Auxiliary interfaces	n/a	n/a	n/a	
Outputs, number	none	16	16	
Inputs, number	16	16	16	
Output current max.	n/a	2 A	2 A	
Connection slots	8x M12x1-Female, 5-pole, A-coded	8x M12x1-Female, 5-pole, A-coded	8x M12x1-Female, 5-pole, A-coded	
Additional function	Extension port	Extension port	Extension port	
Operating voltage U_b	18...30.2 VDC	18...30.2 VDC	18...30.2 VDC	
Ambient temperature	-5...55 °C	-5...55 °C	-5...55 °C	
IP rating	IP69	IP69	IP69	
Cycle time min.				
Scope of delivery	Part label (10x), Blind plugs M12 (4x), Short guide	Part label (10x), Blind plugs M12 (4x), Short guide	Part label (10x), Blind plugs M12 (4x), Short guide	

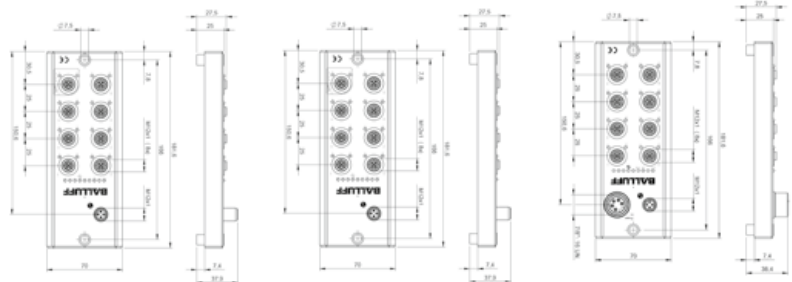

Housing material definitions:
PA Polyamide



BNI002Z BNI IOL-530-000-K006	BNI0006 BNI IOL-104-000-K006	BNI0005 BNI IOL-102-000-K006		
50 x 31 x 115 mm	50 x 31 x 115 mm	50 x 31 x 115 mm		
PA	PA	PA		
IO-Link 1.1	IO-Link 1.0	IO-Link 1.0		
none	none	none		
8x PNP, Type2	16x PNP, Type2	8x PNP, Type2		
none	none	none		
8x DSC	n/a	n/a		
none	none	none		
none	16	8		
n/a	n/a	n/a		
8x M12x1-Female, 5-pole, A-coded	8x M12x1-Female, 5-pole, A-coded	8x M12x1-Female, 5-pole, A-coded		
n/a	n/a	n/a		
18...30.2 VDC	18...30.2 VDC	18...30.2 VDC		
-5...55 °C	-5...55 °C	-5...55 °C		
IP67	IP67	IP67		
2.5 ms	3 ms	3 ms		
Part label (12x), Blind plugs M12 (4x), Short guide	Part label (12x), Blind plugs M12 (4x), Short guide	Part label (12x), Blind plugs M12 (4x), Short guide		

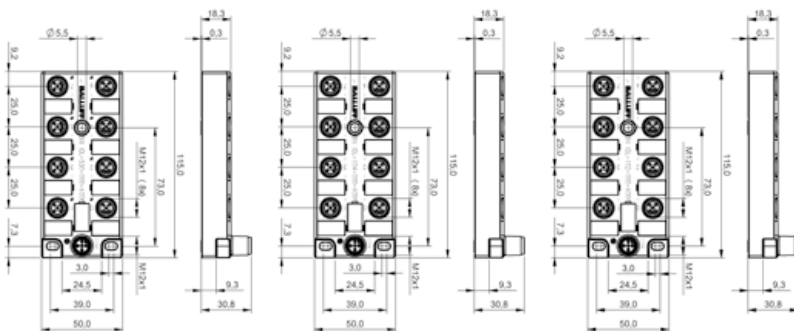



DISCRETE I/O HUBS

	BNI0074 BNI IOL-106-000-K006	BNI0075 BNI IOL-106-S01-K006	BNI0076 BNI IOL-106-S01-K006-C01	
Dimension	50 x 31 x 115 mm	50 x 31 x 115 mm	50 x 31 x 115 mm	
Housing material	PA	PA	PA	
Interface	IO-Link 1.1	IO-Link 1.1	IO-Link 1.1	
Analog inputs	none	none	none	
Digital inputs	16x NPN, Type2	16x NPN, Type2	16x NPN, Type2	
Digital outputs	none	none	none	
Outputs, number	none	none	none	
Inputs, number	16	16	16	
Output current max.	n/a	n/a	n/a	
Connection slots	8x M12x1, 5-pole, A-coded	8x M12x1, 5-pole, A-coded	8x M12x1, 5-pole, A-coded	
Additional function	n/a	n/a	n/a	
Operating voltage U_b	18...30.2 VDC	18...30.2 VDC	18...30.2 VDC	
Ambient temperature	-5...55 °C	-5...55 °C	-5...55 °C	
IP rating	IP67	IP67	IP67	
Cycle time min.	2.5 ms	3 ms	3.5 ms	
Scope of delivery	Part label (12x), Blind plugs M12 (4x), Short guide	Part label (12x), Blind plugs M12 (4x), Short guide	Part label (12x), Blind plugs M12 (4x), Short guide	

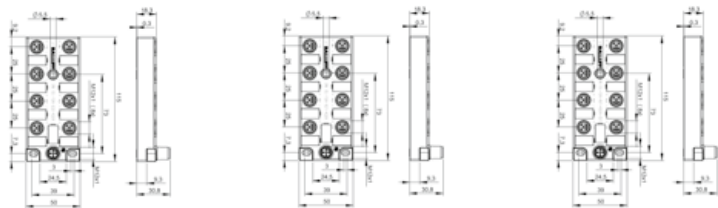

Housing material definitions:
PA Polyamide



BNI005L BNI IOL-302-000-K006	BNI005U BNI IOL-302-000-K006-C01	BNI007Z BNI IOL-302-002-K006	BNI00AW BNI IOL-311-S02-K006-C01	
50 x 31 x 115 mm	50 x 31 x 115 mm	50 x 31 x 115 mm	50 x 31 x 115 mm	
PA	PA	PA	PA	
IO-Link 1.1	IO-Link 1.1	IO-Link 1.1	IO-Link 1.1	
none	none	none	none	
16x PNP, Type2	16x PNP, Type2	16x PNP, Type3	16x NPN, Type3	
16x PNP	16x PNP	16x PNP	none	
16	16	16	none	
16	16	16	16	
350 mA	350 mA	300 mA	200 mA	
8x M12x1, 5-pole, A-coded	8x M12x1, 5-pole, A-coded	8x M12x1, 5-pole, A-coded	8x M12x1, 5-pole, A-coded	
n/a	n/a	Extension port	Extension port, single channel monitoring, identification	
18...30.2 VDC	18...30.2 VDC	18...30.2 VDC	18...30.2 VDC	
-5...55 °C	-5...55 °C	-5...55 °C	-5...55 °C	
IP67	IP67	IP67	IP67	
3.5 ms	4 ms	4.5 ms	6 ms	
Part label (12x), Blind plugs M12 (4x), Short guide	Part label (12x), Blind plugs M12 (4x), Short guide	Part label (12x), Blind plugs M12 (4x), Short guide	Part label (12x), Blind plugs M12 (4x), Short guide	

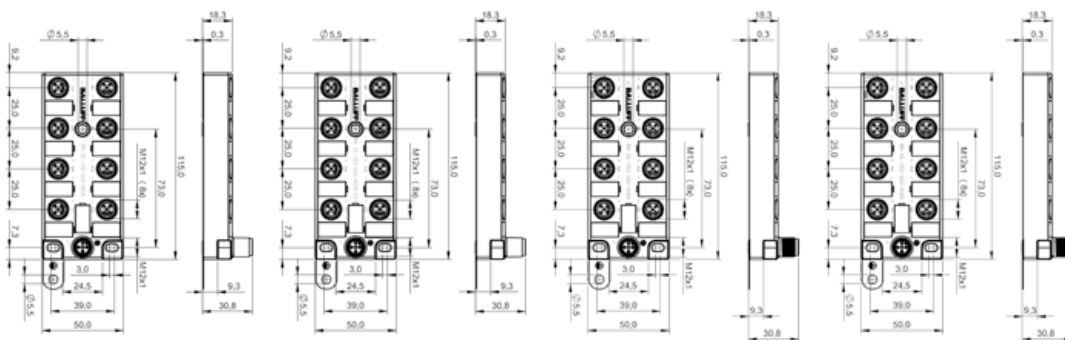



DISCRETE I/O HUBS

	BNI005T BNI IOL-302-S01-K006	BNI005W BNI IOL-302-S01-K006-C01	BNI000P BNI IOL-101-000-K018	
Dimension	50 x 31 x 115 mm	50 x 31 x 115 mm	30 x 24 x 85.5 mm	
Housing material	PA	PA	PBT, GF	
Interface	IO-Link 1.1	IO-Link 1.1	IO-Link 1.0	
Analog inputs	none	none	none	
Digital inputs	16x PNP, Type2	16x PNP, Type2	4x PNP, Type2	
Digital outputs	16x PNP	16x PNP	none	
Outputs, number	16	16	none	
Inputs, number	16	16	4	
Output current max.	350 mA	350 mA	n/a	
Connection slots	8x M12x1 Female, 5-pole, A-coded	8x M12x1 Female, 5-pole, A-coded	4x M8x1 Female, 3-pole	
Operating voltage Ub	18...30.2 VDC	18...30.2 VDC	18...30.2 VDC	
Ambient temperature	-5...55 °C	-5...55 °C	-5...55 °C	
IP rating	IP67	IP67	IP67	
Cycle time min.	5 ms	5.5 ms	2.5 ms	
Scope of delivery	Part label (12x), Blind plugs M12 (4x), Short guide	Part label (12x), Blind plugs M12 (4x), Short guide	Part label (12x), Blind plugs M8 (2x), Short guide	

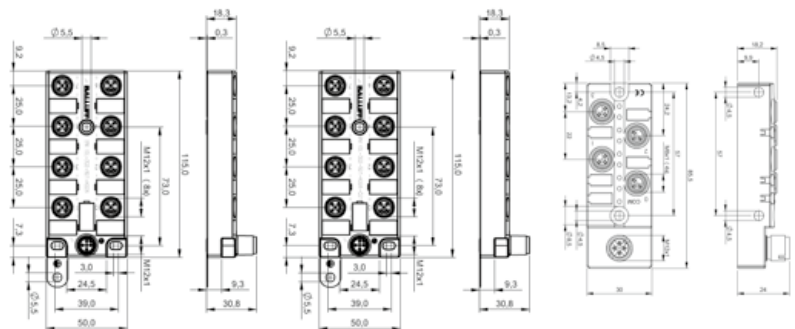

Housing material definitions:
 GF Glass Fiber
 PA Polyamide
 PBT Polybuteneterephthalate



BNI001W BNI IOL-101-S01-K018	BNI0021 BNI IOL-104-000-K021	BNI0022 BNI IOL-104-S01-K021	BNI000R BNI IOL-102-000-K019	BNI001Y BNI IOL-102-S01-K019
30 x 24 x 85.5 mm	30 x 24 x 129.5 mm	30 x 24 x 129.5 mm	30 x 24 x 129.5 mm	30 x 24 x 129.5 mm
PBT, GF	PBT, GF	PBT, GF	PBT, GF	PBT, GF
IO-Link 1.0	IO-Link 1.0	IO-Link 1.0	IO-Link 1.0	IO-Link 1.0
none	none	none	none	none
4x PNP, Type2	16x PNP, Type2	16x PNP, Type2	8x PNP, Type2	8x PNP, Type2
none	none	none	none	none
none	none	none	none	none
4	16	16	8	8
n/a	n/a	n/a	n/a	n/a
4x M8x1 Female, 3-pole	8x M8x1 Female, 4-pole	8x M8x1 Female, 4-pole	8x M8x1 Female, 3-pole	8x M8x1 Female, 3-pole
18...30.2 VDC	18...30.2 VDC	18...30.2 VDC	18...30.2 VDC	18...30.2 VDC
-5...55 °C	-5...55 °C	-5...55 °C	-5...55 °C	-5...55 °C
IP67	IP67	IP67	IP67	IP67
2.5 ms	2.5 ms	2.5 ms	2.5 ms	2.5 ms
Part label (12x), Blind plugs M8 (2x), Short guide	Part label (12x), Blind plugs M8 (4x), Short guide	Part label (12x), Blind plugs M8 (4x), Short guide	Part label (12x), Blind plugs M8 (4x), Short guide	Part label (12x), Blind plugs M8 (4x), Short guide

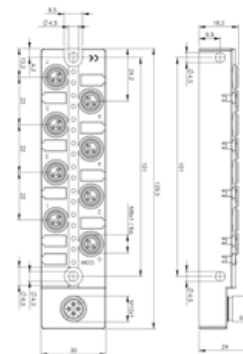
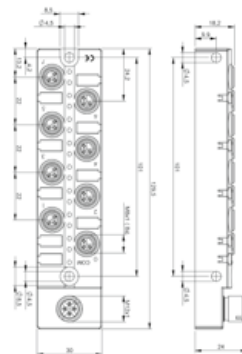
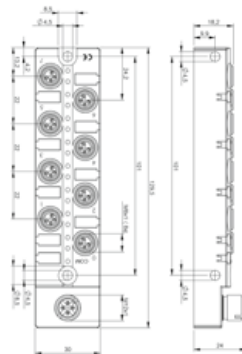
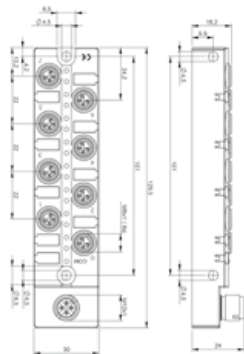
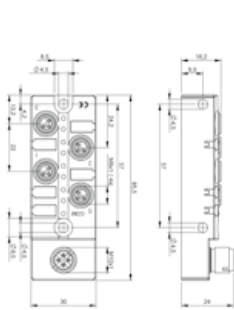



DISCRETE I/O HUBS

	BNI0090 BNI IOL-104-S02-R012	BNI00CH BNI IOL-104-S02-R012-008	BNI0091 BNI IOL-302-S02-R026	
Dimension	68 x 36.8 x 183.5 mm	68 x 36.8 x 183.5 mm	68 x 37.6 x 183.5 mm	
Housing material	PPS	PPS	PPS	
Interface	IO-Link 1.1	IO-Link 1.1	IO-Link 1.1	
Analog inputs	none	none	none	
Digital inputs	16x PNP, Type3	16x PNP, Type3	16x PNP, Type3	
Digital outputs	none	none	16x PNP	
Outputs, number	none	none	16	
Inputs, number	16	16	16	
Output current max.	n/a	n/a	2 A	
Connection slots	8x M12 Female, 5-pole, A-coded	8x M12 Female, 5-pole, A-coded	8x M12 Female, 5-pole, A-coded	
Additional function	Extension port	Extension port	Extension port	
Operating voltage U_b	18...30.2 VDC	18...30.2 VDC	18...30.2 VDC	
Ambient temperature	-5...70 °C	-5...70 °C	-5...70 °C	
IP rating	IP67	IP67	IP67	
Cycle time min.	4.5 ms	4.5 ms	6 ms	
Scope of delivery	Part label (10x), Blind plugs M12 (4x), Ground strap, Lock washer, Short guide, M4x6 screw	Part label (10x), Blind plugs M12 (4x), Ground strap, Lock washer, Short guide, M4x6 screw	Part label (10x), Blind plugs M12 (4x), Ground strap, Lock washer, Short guide, M4x6 screw	

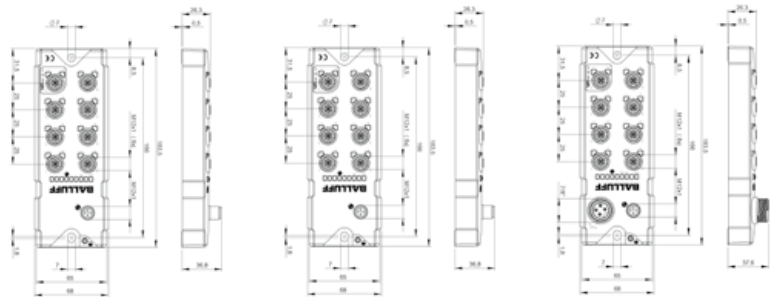

Housing material definitions:
 PPS Polyphenylene Sulfide
 PVC Polyvinylchloride



BNI00CJ BNI IOL-302-S02-R026-008	BNI004K BNI IOL-309-000-K024	BNI007P BNI IOL-309-000-K024-001	BNI004L BNI IOL-310-000-K025	BNI007R BNI IOL-310-000-K025-001
68 x 37.6 x 183.5 mm	84 x 48.8 x 42.6 mm	84 x 48.8 x 42.6 mm	84 x 79.2 x 42.6 mm	84 x 79.2 x 42.6 mm
PPS	PVC, UL94-0	PVC, UL94-0	PVC, UL94-0	PVC, UL94-0
IO-Link 1.1	IO-Link 1.0	IO-Link 1.0	IO-Link 1.0	IO-Link 1.0
none	none	none	none	none
16x PNP, Type3	8x PNP, Type2	8x PNP, Type2	16x PNP, Type2	16x PNP, Type2
16x PNP	8x PNP	8x PNP	16x PNP	16x PNP
16	8	8	16	16
16	8	8	16	16
2 A	350 mA	350 mA	350 mA	350 mA
8x M12 Female, 5-pole, A-coded	8x screw terminals	open terminal ports	16x screw terminals	open terminal ports
Extension port	n/a	n/a	n/a	n/a
18...30.2 VDC	18...30.2 VDC	18...30.2 VDC	18...30.2 VDC	18...30.2 VDC
-5...70 °C	-5...50 °C	-5...50 °C	-5...50 °C	-5...50 °C
IP67	IP20	IP20	IP20	IP20
6 ms	3 ms	3 ms	3 ms	3 ms
Part label (10x), Blind plugs M12 (4x), Ground strap, Lock washer, Short guide, M4x6 screw	Module, Screw terminal (for BAM01ZF), Short guide	Module, Short guide	Module, Screw terminal (for BAM01ZH), Short guide	Module, Short guide

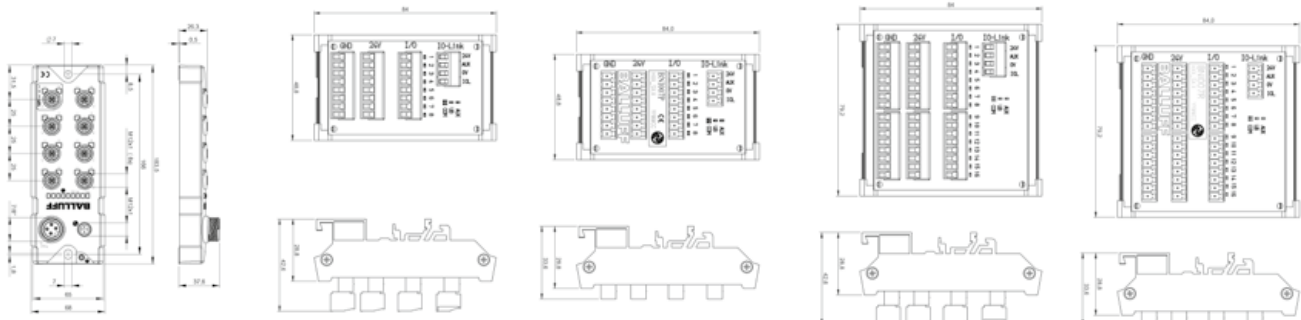



DISCRETE I/O HUBS

	BNI00CM BNI IOL-302-002-Z042	BNI00CN BNI IOL-302-S02-Z012	BNI0046 BNI IOL-302-S02-Z013	
Dimension	68 x 31.8 x 181.5 mm	68 x 31.8 x 181.5 mm	68 x 31.8 x 181.5 mm	
Housing material	Die-cast zinc	Die-cast zinc	Die-cast zinc	
Interface	IO-Link 1.1	IO-Link 1.0	IO-Link 1.1	
Analog inputs	none	none	none	
Digital inputs	16x PNP, Type 3	16x PNP, Type 3	16x PNP, Type 3	
Digital outputs	16x PNP	16x PNP	16x PNP	
Outputs, number	16	16	16	
Inputs, number	16	16	16	
Output current max.	2 A	400 mA	2 A	
Connection slots	8x M12x1 Female, 5-pole, A-coded	8x M12x1 Female, 5-pole, A-coded	8x M12x1-Female, 5-pole, A-coded	
Additional function	n/a	Extension port	n/a	
Operating voltage U_b	18...30.2 VDC	18...30.2 VDC	18...30.2 VDC	
Ambient temperature	-5...55 °C	-5...55 °C	-5...55 °C	
IP rating	IP67	IP67	IP67	
Cycle time min.	4.4 ms	4.4 ms	6.2 ms	
Scope of delivery	Part label (20x), Blind plugs M12 (4x), Ground strap, Lock washer, Short guide, M4x6 screw	Part label (20x), Blind plugs M12 (4x), Ground strap, Lock washer, Short guide, M4x6 screw	Part label (20x), Blind plugs M12 (4x), Ground strap, Lock washer, Short guide, M4x6 screw	

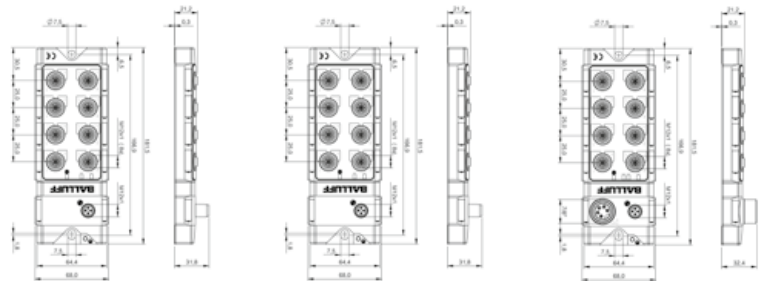



BNI00CP BNI IO L-302-S02-Z026	BNI00CR BNI IO L-104-S02-Z012			
68 x 31.8 x 181.5 mm	68 x 31.8 x 181.5 mm			
Die-cast zinc	Die-cast zinc			
IO-Link 1.1	IO-Link 1.1			
none	none			
16x PNP, Type 3	16x PNP, Type 3			
16x PNP	none			
16	none			
16	16			
2 A	n/a			
8x M12x1-Female, 5-pole, A-coded	8x M12x1-Female, 5-pole, A-coded			
n/a	Extension port			
18...30.2 VDC	18...30.2 VDC			
-5...55 °C	-5...55 °C			
IP67	IP67			
5.6 ms	4.4 ms			
Part label (20x), Blind plugs M12 (4x), Ground strap, Lock washer, Short guide, M4x6 screw	Part label (20x), Blind plugs M12 (4x), Ground strap, Lock washer, Short guide, M4x6 screw			

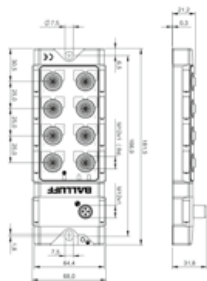
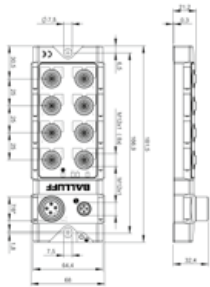



DISCRETE I/O HUBS

	BNI0043 BNI IOL-205-000-Z012	BNI0032 BNI IOL-104-000-Z012	BNI0039 BNI IOL-104-S01-Z012	
Dimension	68 x 31.8 x 181.5 mm	68 x 31.8 x 181.5 mm	68 x 31.8 x 181.5 mm	
Housing material	Die-cast zinc	Die-cast zinc	Die-cast zinc	
Interface	IO-Link 1.0	IO-Link 1.0	IO-Link 1.0	
Analog inputs	none	none	none	
Digital inputs	none	16x PNP, Type2	16x PNP, Type2	
Digital outputs	16	none	none	
Outputs, number	16	none	none	
Inputs, number	none	16	16	
Output current max.	500 mA	n/a	n/a	
Connection slots	8x M12x1 Female, 5-pole, A-coded	8x M12x1 Female, 5-pole, A-coded	8x M12x1 Female, 5-pole, A-coded	
Additional function	n/a	n/a	n/a	
Operating voltage U_b	18...30.2 VDC	18...30.2 VDC	18...30.2 VDC	
Ambient temperature	-5...70 °C	-5...70 °C	-5...70 °C	
IP rating	IP67	IP67	IP67	
Cycle time min.	3 ms	3 ms	3 ms	
Scope of delivery	Part label (20x), Blind plugs M12 (4x), Ground strap, Lock washer, Short guide, M4x6 screw	Part label (20x), Blind plugs M12 (4x), Ground strap, Lock washer, Short guide, M4x6 screw	Part label (20x), Blind plugs M12 (4x), Ground strap, Lock washer, Short guide, M4x6 screw	

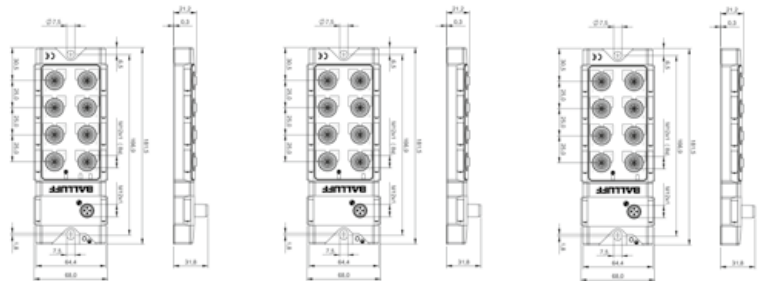



BNI003T BNI IOL-104-S01-Z012-C01				
68 x 31.8 x 181.5 mm				
Die-cast zinc				
IO-Link 1.0				
none				
16x PNP, Type2				
none				
none				
16				
n/a				
8x M12x1 Female, 5-pole, A-coded				
n/a				
18...30.2 VDC				
-5...70 °C				
IP67				
3 ms				
Part label (20x), Blind plugs M12 (4x), Ground strap, Lock washer, Short guide, M4x6 screw				

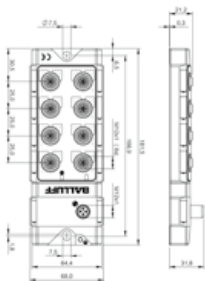



DISCRETE I/O HUBS

	BNI005P BNI IOL-104-S01-Z012-C02	BNI0080 BNI IOL-302-000-Z042	BNI003U BNI IOL-302-000-Z012	
Dimension	68 x 31.8 x 181.5 mm	68 x 31.8 x 181.5 mm	68 x 31.8 x 181.5 mm	
Housing material	Die-cast zinc	Die-cast zinc	Die-cast zinc	
Interface	IO-Link 1.0	IO-Link 1.0	IO-Link 1.0	
Analog inputs	none	none	none	
Digital inputs	16x PNP, Type2	16x PNP, Type2	16x PNP, Type2	
Digital outputs	none	8x PNP	16x PNP	
Outputs, number	16	8	16	
Inputs, number	16	16	16	
Output current max.	n/a	2A	2 A	
Connection slots	8x M12 Female, 5-pole, A-coded	8x M12 Female, 5-pole, A-coded	8x M12 Female, 5-pole, A-coded	
Additional function	n/a	n/a	n/a	
Operating voltage U_b	18...30.2 VDC	18...30.2 VDC	18...30.2 VDC	
Ambient temperature	-5...70 °C	-5...70 °C	-5...70 °C	
IP rating	IP67	IP67	IP67	
Cycle time min.	3 ms	3 ms	3 ms	
Scope of delivery	Part label (20x), Blind plugs M12 (4x), Ground strap, Lock washer, Short guide, M4x6 screw	Part label (20x), Blind plugs M12 (4x), Ground strap, Lock washer, Short guide, M4x6 screw	Part label (20x), Blind plugs M12 (4x), Ground strap, Lock washer, Short guide, M4x6 screw	

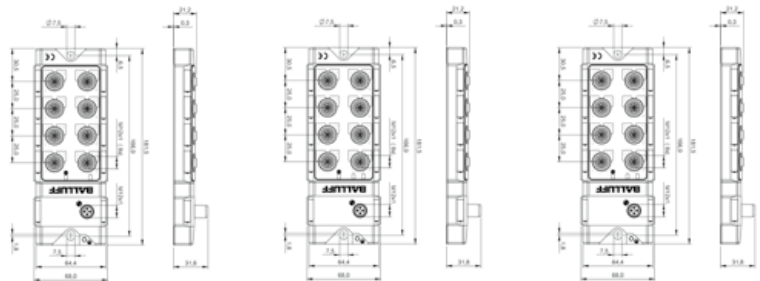



BNI0035 BNI IOL-302-000-Z013	BNI0050 BNI IOL-302-000-Z026	BNI003C BNI IOL-302-S01-Z012	BNI003A BNI IOL-302-S01-Z013	
68 x 32.4 x 181.5 mm	68 x 32.4 x 181.5 mm	68 x 31.8 x 181.5 mm	68 x 32.4 x 181.5 mm	
Die-cast zinc	Die-cast zinc	Die-cast zinc	Die-cast zinc	
IO-Link 1.0	IO-Link 1.0	IO-Link 1.0	IO-Link 1.0	
none	none	none	none	
16x PNP, Type2	16x PNP, Type2	16x PNP, Type2	16x PNP, Type2	
16x PNP	16x PNP	16x PNP	16x PNP	
16	16	16	16	
16	16	16	16	
2 A	2 A	2 A	2 A	
8x M12 Female, 5-pole, A-coded	8x M12 Female, 5-pole, A-coded	8x M12 Female, 5-pole, A-coded	8x M12 Female, 5-pole, A-coded	
n/a	n/a	n/a	n/a	
18...30.2 VDC	18...30.2 VDC	18...30.2 VDC	18...30.2 VDC	
-5...70 °C	-5...70 °C	-5...70 °C	-5...70 °C	
IP67	IP67	IP67	IP67	
3 ms	3 ms	3 ms	3 ms	
Part label (20x), Blind plugs M12 (4x), Ground strap, Lock washer, Short guide, M4x6 screw	Part label (20x), Blind plugs M12 (4x), Ground strap, Lock washer, Short guide, M4x6 screw	Part label (20x), Blind plugs M12 (4x), Ground strap, Lock washer, Short guide, M4x6 screw	Part label (20x), Blind plugs M12 (4x), Ground strap, Lock washer, Short guide, M4x6 screw	

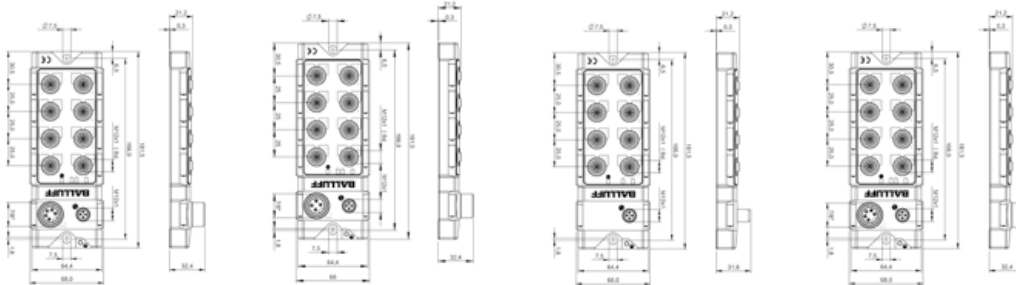



DISCRETE I/O HUBS

	BNI0048 BNI IOL-302-S01-Z013-C01	BNI0051 BNI IOL-302-S01-Z026	BNI0031 BNI IOL-102-000-Z012	
Dimension	68 x 32.4 x 181.5 mm	68 x 32.4 x 181.5 mm	68 x 31.8 x 181.5 mm	
Housing material	Die-cast zinc	Die-cast zinc	Die-cast zinc	
Interface	IO-Link 1.0	IO-Link 1.0	IO-Link 1.0	
Analog inputs	none	none	none	
Digital inputs	16x PNP, Type2	16x PNP, Type2	8x PNP, Type2	
Digital outputs	16x PNP	16x PNP	none	
Outputs, number	16	16	none	
Inputs, number	16	16	8	
Output current max.	2 A	2 A	n/a	
Connection slots	8x M12x1-Female, 5-pole, A-coded	8x M12x1-Female, 5-pole, A-coded	8x M12x1-Female, 5-pole, A-coded	
Additional function	n/a	n/a	n/a	
Operating voltage U_b	18...30.2 VDC	18...30.2 VDC	18...30.2 VDC	
Ambient temperature	-5...70 °C	-5...70 °C	-5...70 °C	
IP rating	IP67	IP67	IP67	
Cycle time min.	3 ms	3 ms	3 ms	
Scope of delivery	Part label (20x), Blind plugs M12 (4x), Ground strap, Lock washer, Short guide, M4x6 screw	Part label (20x), Blind plugs M12 (4x), Ground strap, Lock washer, Short guide, M4x6 screw	Part label (20x), Blind plugs M12 (4x), Ground strap, Lock washer, Short guide, M4x6 screw	

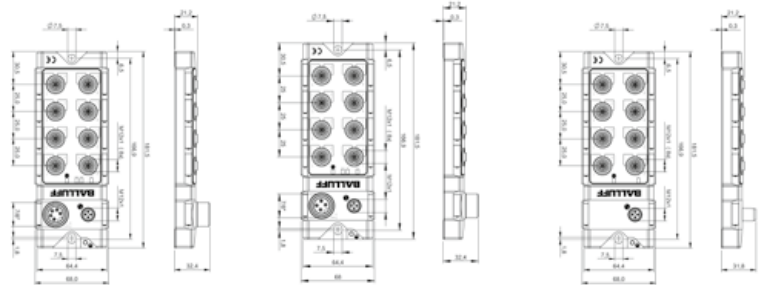



BNI0063 BNI IOL-106-000-Z012	BNI0062 BNI IOL-106-S01-Z012	BNI0061 BNI IOL-106-S01-Z012-C01		
68 x 31.8 x 181.5 mm	68 x 31.8 x 181.5 mm	68 x 31.8 x 181.5 mm		
Die-cast zinc	Die-cast zinc	Die-cast zinc		
IO-Link 1.1	IO-Link 1.1	IO-Link 1.1		
none	none	none		
16x NPN, Type2	16x NPN, Type2	16x NPN, Type2		
none	none	none		
none	none	none		
16	16	16		
n/a	n/a	n/a		
8x M12x1-Female, 5-pole, A-coded	8x M12x1-Female, 5-pole, A-coded	8x M12x1-Female, 5-pole, A-coded		
n/a	n/a	n/a		
18...30.2 VDC	18...30.2 VDC	18...30.2 VDC		
-5...70 °C	-5...70 °C	-5...70 °C		
IP67	IP67	IP67		
2.5 ms	3 ms	3.5 ms		
Part label (20x), Blind plugs M12 (4x), Ground strap, Lock washer, Short guide, M4x6 screw	Part label (20x), Blind plugs M12 (4x), Ground strap, Lock washer, Short guide, M4x6 screw	Part label (20x), Blind plugs M12 (4x), Ground strap, Lock washer, Short guide, M4x6 screw		

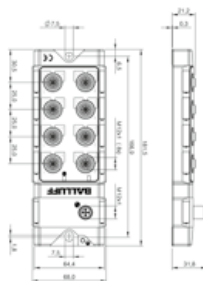
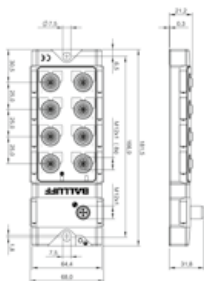
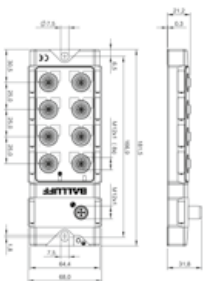



DISCRETE I/O HUBS

	BNI0099 BNI IOL-102-002-Z019	BNI0093 BNI IOL-309-002-Z019	BNI00AU BNI IOL-302-002-Z046	
Dimension	30 x 32.5 x 132 mm	30 x 32.5 x 132 mm	30 x 32.8 x 220 mm	
Housing material	Die-cast zinc	Die-cast zinc	Die-cast zinc	
Interface	IO-Link 1.1	IO-Link 1.1	IO-Link 1.1	
Analog inputs	none	none	none	
Digital inputs	8x PNP, Type3	8x PNP, Type3	16x PNP, Type 3	
Digital outputs	none	8x PNP	8x PNP	
Outputs, number	none	8	16	
Inputs, number	8	8	16	
Output current max.	n/a	300 mA	300 mA	
Connection slots	8x M8 Female, 3-pole	8x M8 Female, 3-pole	16x M8 Female, 3-pole	
Additional function	Extension port	Extension port	Extension port	
Operating voltage U_b	18...30.2 VDC	18...30.2 VDC	18...30.2 VDC	
Ambient temperature	-5...55 °C	-5...55 °C	-5...55 °C	
IP rating	IP67	IP67	IP67	
Cycle time min.	3.2 ms	3.5 ms	4.0 ms	
Scope of delivery	Module, Blind plugs M8 (4x), Ground strap, Lock washer, Short guide, M4x6 screw	Module, Blind plugs M8 (4x), Ground strap, Lock washer, Short guide, M4x6 screw	Module, Part label (28x), Blind plugs M8 (4x), Ground strap, Lock washer, Short guide, M4x6 screw	

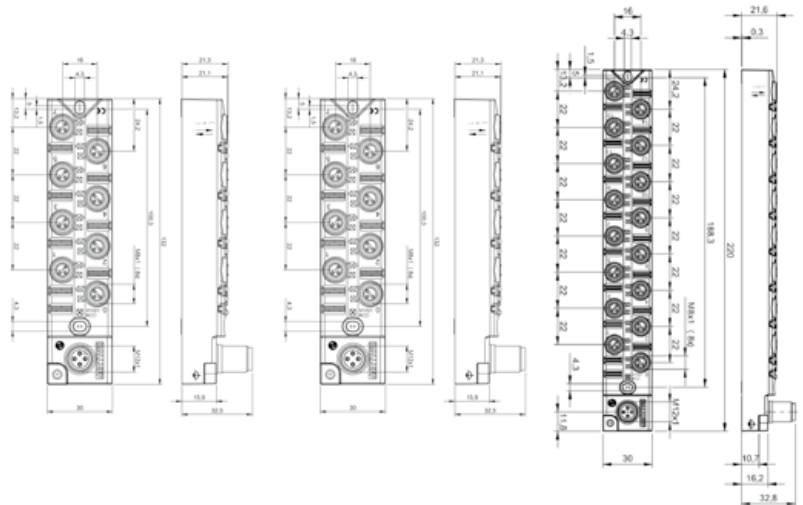

VALVE INTERFACES



	BNI006J BNI IOL-750-V08-K007	BNI006K BNI IOL-750-V10-K007	BNI006N BNI IOL-751-V08-K007	
Principle of operation	Active splitter	Active splitter	Active splitter	
Dimension	53 x 60.8 x 12.5 mm	53 x 60.8 x 12.5 mm	53 x 60.8 x 12.5 mm	
Housing material	PA	PA	PA	
Interface	IO-Link 1.1	IO-Link 1.1	IO-Link 1.1	
Port class	A	A	A	
Digital inputs	none	none	none	
Digital outputs	24	24	24	
Outputs, number	24	24	24	
Output current max.	300 mA	300 mA	300 mA, separate output power	
Connection slots	25 pin D-sub female	25 pin, D-sub female	25 pin, D-sub female	
Operating voltage U_b	18...30.2 VDC	18...30.2 VDC	18...30.2 VDC	
Ambient temperature	-5...55 °C	-5...55 °C	-5...55 °C	
IP rating	IP40	IP40	IP40	
For use with	Festo MPA	SMC VQC	Festo MPA	

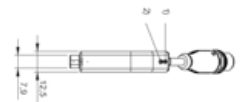
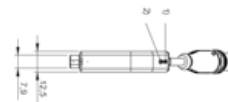
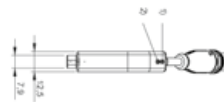
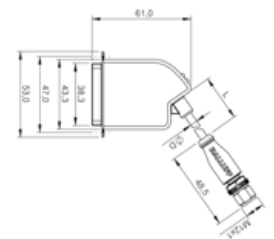
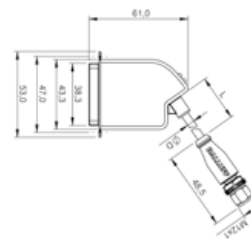
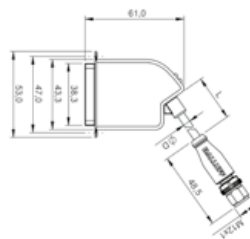

Housing material definitions:
PA Polyamide



BNI006P BNI IOL-751-V10-K007	BNI006Y BNI IOL-752-V08-K007	BNI006Z BNI IOL-752-V10-K007	BNI006L BNI IOL-750-V13-K007	BNI006M BNI IOL-751-V09-K007
Active splitter	Active splitter	Active splitter	Active splitter	Active splitter
53 x 60.8 x 12.5 mm	53 x 60.8 x 12.5 mm	53 x 60.8 x 12.5 mm	53 x 60.8 x 12.5 mm	53 x 60.8 x 12.5 mm
PA	PA	PA	PA	PA
IO-Link 1.1	IO-Link 1.1	IO-Link 1.1	IO-Link 1.1	IO-Link 1.1
A	B	B	B	B
none	none	none	none	none
24	24	24	22	16
24	24	24	22	16
300 mA separate output power	300 mA, isolated output power	300 mA, isolated output power	300 mA	300 mA, separate output power
25 pin, D-sub female	25 pin, D-sub female	25 pin, D-sub female	25 pin, D-sub female	25 pin, D-sub female
18...30.2 VDC	18...30.2 VDC	18...30.2 VDC	18...30.2 VDC	18...30.2 VDC
-5...55 °C	-5...55 °C	-5...55 °C	-5...55 °C	-5...55 °C
IP40	IP40	IP40	IP40	IP40
SMC VQC	Festo MPA	SMC VQC	Numatics	Festo CPV

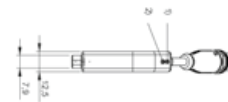
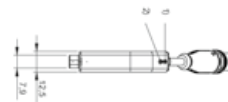
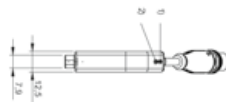
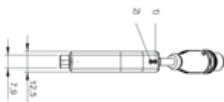
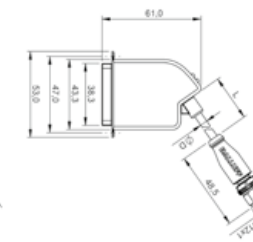
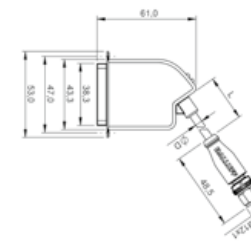
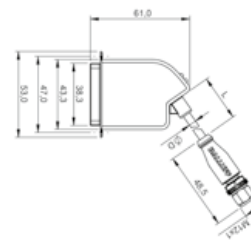
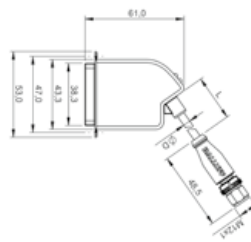
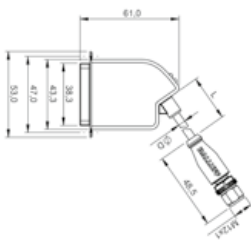

VALVE INTERFACES



	BNI006R BNI IOL-751-V13-K007	BNI006F BNI IOL-752-V13-K007	BNI006E BNI IOL-750-V09-K007	
Principle of operation	Active splitter	Active splitter	Active splitter	
Dimension	53 x 60.8 x 12.5 mm	53 x 60.8 x 12.5 mm	53 x 60.8 x 12.5 mm	
Housing material	PA	PA	PA	
Interface	IO-Link 1.1	IO-Link 1.1	IO-Link 1.1	
Port class	A	B	A	
Digital inputs	0	0	0	
Digital outputs	22	22	16	
Outputs, number	22	22	16	
Output current max.	300 mA, separate output power	300 mA, isolated output power	300 mA	
Connection slots	25 pin D-sub female	25 pin D-sub female	25 pin D-sub female	
Operating voltage U_b	18...30.2 VDC	18...30.2 VDC	18...30.2 VDC	
Ambient temperature	-5...55 °C	-5...55 °C	-5...55 °C	
IP rating	IP40	IP40	IP40	
For use with	Numatics	Numatics	Festo CPV	

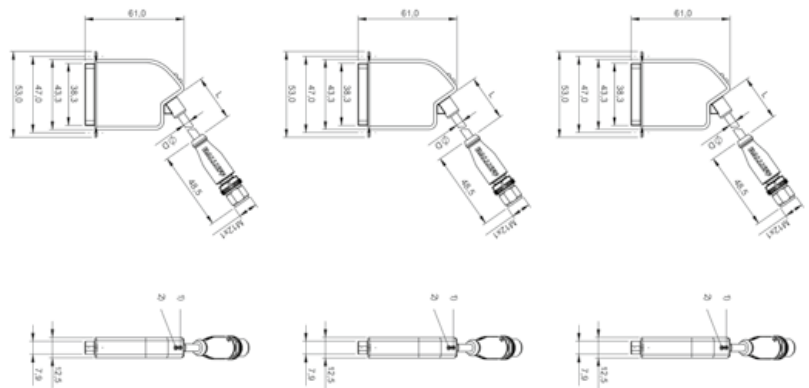

Housing material definitions:
PA Polyamide



BNI006H BNI IOL-750-V11-K007	BNI006T BNI IOL-751-V11-K007	BNI006U BNI IOL-752-V09-K007	BNI006W BNI IOL-752-V11-K007	
Active splitter	Active splitter	Active splitter	Active splitter	
53 x 60.8 x 12.5 mm	53 x 60.8 x 12.5 mm	53 x 60.8 x 12.5 mm	53 x 60.8 x 12.5 mm	
PA	PA	PA	PA	
IO-Link 1.1	IO-Link 1.1	IO-Link 1.1	IO-Link 1.1	
A	A	B	B	
0	0	0	0	
16	16	16	16	
16	16	16	16	
300 mA	300 mA, separate output power	300 mA, isolated output power	300 mA, isolated output power	
25 pin D-sub female	25 pin D-sub female	25 pin D-sub female	25 pin D-sub female	
18...30.2 VDC	18...30.2 VDC	18...30.2 VDC	18...30.2 VDC	
-5...55 °C	-5...55 °C	-5...55 °C	-5...55 °C	
IP40	IP40	IP40	IP40	
SMC VQC	SMC VQC	Festo CPV	SMC VQC	

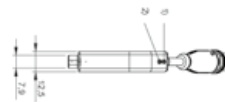
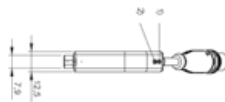
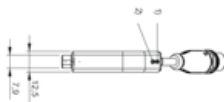
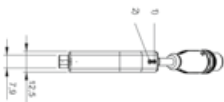
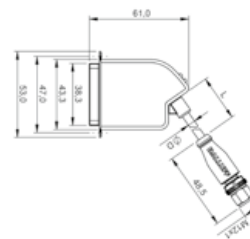
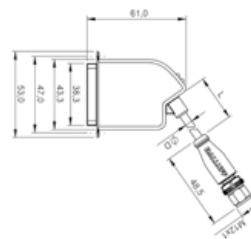
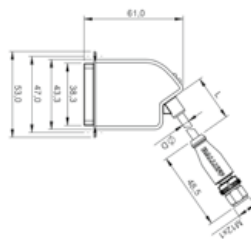
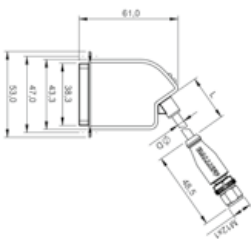

VALVE INTERFACES



	BNI001F BNI IOL-750-V01-K007	BNI001H BNI IOL-750-V03-K007	BNI001K BNI IOL-751-V01-K007	
Principle of operation	Active splitter	Active splitter	Active splitter	
Dimension	53 x 60.8 x 12.5 mm	53 x 60.8 x 12.5 mm	53 x 60.8 x 12.5 mm	
Housing material	PA	PA	PA	
Interface	IO-Link 1.0	IO-Link 1.0	IO-Link 1.0	
Port class	A	A	A	
Digital inputs	none	none	none	
Digital outputs	24	24	24	
Outputs, number	24	24	24	
Output current max.	2 A	2 A	2 A, separate output power	
Connection slots	25 pin, D-sub female	25 pin, D-sub female	25 pin, D-sub female	
Operating voltage U_b	18...30.2 VDC	18...30.2 VDC	18...30.2 VDC	
Ambient temperature	-5...55 °C	-5...55 °C	-5...55 °C	
IP rating	IP40	IP40	IP40	
For use with	Festo MPA	SMC VQC	Festo MPA	

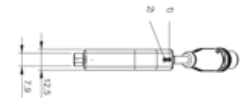
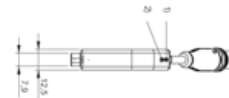
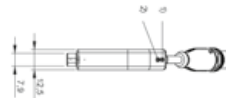
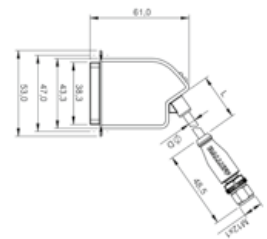
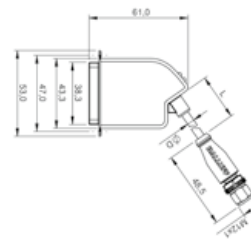
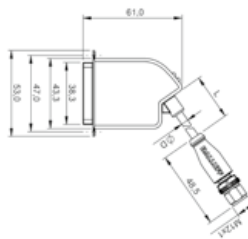

Housing material definitions:
PA Polyamide



BNI001M BNI IOL-751-V03-K007	BNI001E BNI IOL-750-V02-K007	BNI001J BNI IOL-750-V04-K007	BNI001L BNI IOL-751-V02-K007	BNI001N BNI IOL-751-V04-K007
Active splitter	Active splitter	Active splitter	Active splitter	Active splitter
53 x 60.8 x 12.5 mm	53 x 60.8 x 12.5 mm	53 x 60.8 x 12.5 mm	53 x 60.8 x 12.5 mm	53 x 60.8 x 12.5 mm
PA	PA	PA	PA	PA
IO-Link 1.0	IO-Link 1.0	IO-Link 1.0	IO-Link 1.0	IO-Link 1.0
A	A	A	A	A
none	none	none	none	none
24	16	16	16	16
24	16	16	16	16
2 A, separate output power	2 A	2 A	2 A, separate output power	2 A, separate output power
25 pin, D-sub female	25 pin, D-sub female	25 pin, D-sub female	25 pin, D-sub female	25 pin, D-sub female
18...30.2 VDC	18...30.2 VDC	18...30.2 VDC	18...30.2 VDC	18...30.2 VDC
-5...55 °C	-5...55 °C	-5...55 °C	-5...55 °C	-5...55 °C
IP40	IP40	IP40	IP40	IP40
SMC VQC	Festo CPV	SMC VQC	Festo CPV	SMC VQC

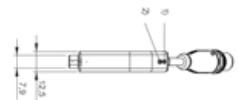
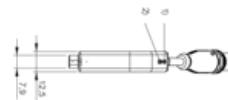
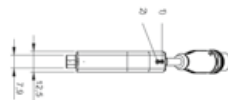
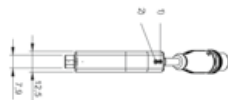
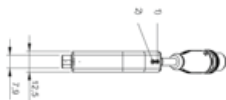
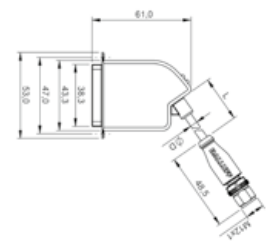
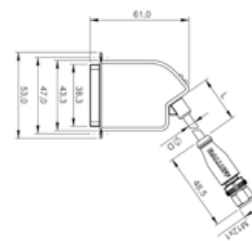
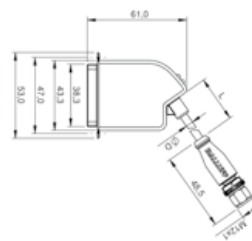
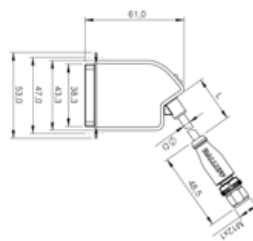
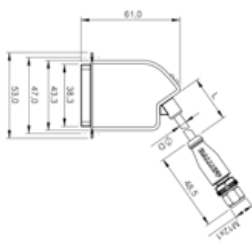

UNIVERSAL DISCRETE I/O



	BNI004W BNI IOL-770-V06-A027	BNI007E BNI IOL-770-000-A027	BNI005Z BNI IOL-771-000-A027	
Dimension	31.8 x 31.8 x 185 mm	31.8 x 31.8 x 185 mm	31.8 x 31.8 x 185 mm	
Housing material	Aluminum	Aluminum	Aluminum	
Connection slots	M27 Female 26-pole	Open cable, 25-pole	Open cable, 17-pole	
Analog inputs	none	none	none	
Analog output	none	none	none	
Digital inputs	none	none	none	
Digital outputs	24xPNP	24xPNP	16xPNP	
Outputs, number	24	24	16	
Inputs, number	none	none	none	
Output current max.	300 mA	300 mA	300 mA	
Additional function	Broken wire detect	Broken wire detect	Broken wire detect	
Interface	IO-Link 1.1	IO-Link 1.1	IO-Link 1.1	
Ambient temperature	-5...70 °C	-5...55 °C	-5...55 °C	
IP rating	IP67	IP67	IP67	

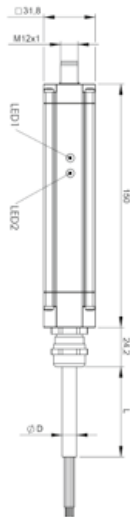
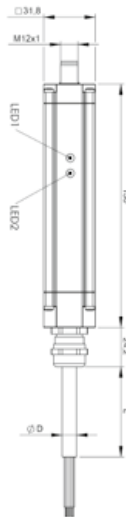
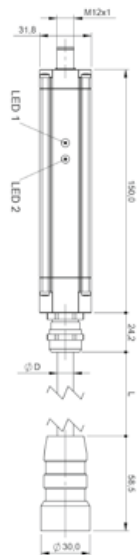



BNI005Y BNI IOL-772-000-A027	BNI00AE BNI IOL-772-002-E032	BNI005M BNI IOL-771-000-K027	BNI005N BNI IOL-772-000-K027	
31.8 x 31.8 x 180 mm	18 x 18 x 1775 mm	43.3 x 15 x 83.3 mm	43.3 x 15 x 83.3 mm	
Aluminum	Stainless steel (1.4305)	PA	PA	
Open cable, 10-pole	Open cable, 10-pole	Open cable, 17-pole	Open cable	
none	none	none	none	
none	none	none	none	
none	8x PNP, Type 3	16	8	
8xPNP	8x IO configurable	16	8	
8	8	16	8	
none	8	16	8	
300 mA	1.6 A	200 mA	200 mA	
Broken wire detect	none	none	none	
IO-Link 1.1	IO-Link 1.1	IO-Link 1.1	IO-Link 1.1	
-5...55 °C	-5...60 °C	-5...55 °C	-5...55 °C	
IP67	IP69K/IP68	IP54	IP54	

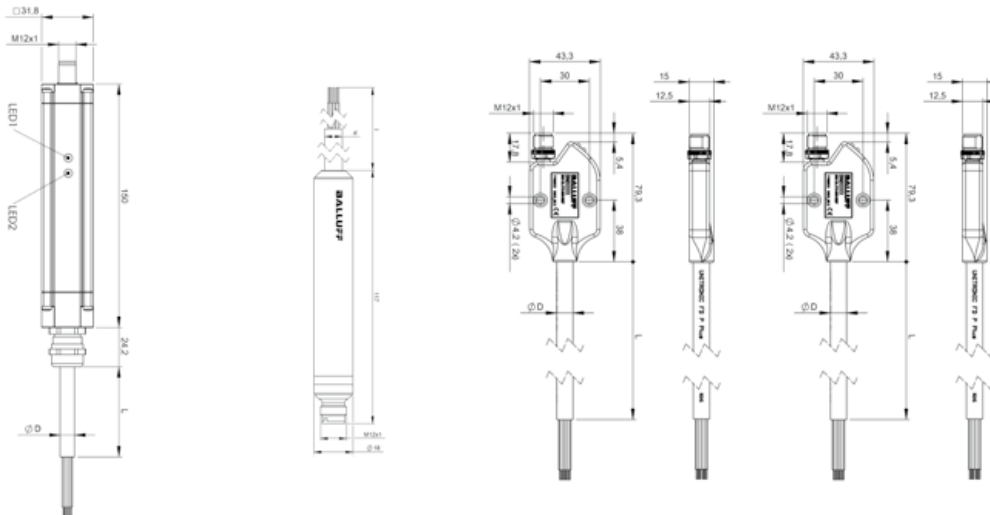

ANALOG IO



	BNI004C BNI IOL-722-000-K023	BNI004E BNI IOL-724-000-K023	BNI0042 BNI IOL-714-000-K023	
Dimension	14.2 x 50.4 x 40 mm	14.2 x 50.4 x 40 mm	14.2 x 50.4 x 40 mm	
Housing material	PA	PA	PA	
Connection slots	M12x1 Female, 5-pole, A-coded	M12x1 Female, 5-pole, A-coded	M12x1 Female, 5-pole, A-coded	
Analog inputs	none	none	Analog, voltage (0...10 V)	
Analog output	Analog, current (4...20 mA)	Analog, voltage (0...100 mA)	none	
Digital inputs	none	none	none	
Digital outputs	none	none	none	
Outputs, number	1	1	none	
Inputs, number	none	none	1	
Output current max.	none	none	none	
Additional function	none	none	none	
Interface	IO-Link 1.0	IO-Link 1.0	IO-Link 1.0	
Ambient temperature	-5...70 °C	-5...70 °C	-5...70 °C	
IP rating	IP67	IP67	IP67	

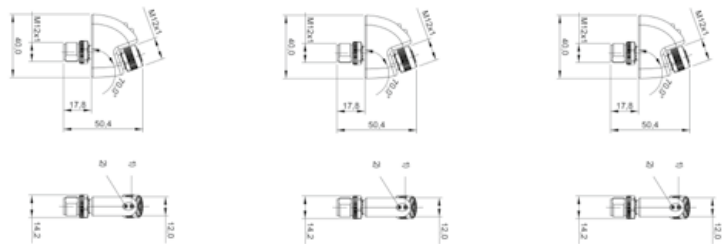

Housing material definitions:
PA Polyamide



BNI0041 BNI IOL-712-000-K023	BNI004T BNI IOL-716-000-K023			
14.2 x 50.4 x 40 mm	14.2 x 50.4 x 40 mm			
PA	PA			
M12 Female-5pole, A-coded	M12 Female-5pole, A-coded			
Analog, current (4...20 mA)	Analog, temperature (Pt100)			
none	none			
none	none			
none	none			
none	none			
1	1			
none	none			
none	none			
IO-Link 1.0	IO-Link 1.0			
-5...70 °C	-5...70 °C			
IP67	IP67			

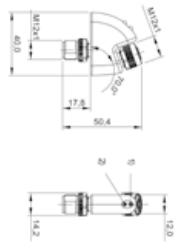
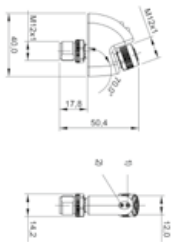

TEMPERATURE AND ANALOG I/O



	BNI00C6 BNI IO-730-002-E023	BNI00C7 BNI IO-740-002-E023	BNI00C8 BNI IO-725-002-E023	
Principle of operation	Converter	Converter	Converter	
Dimension	Ø18 135.5 mm	Ø18 135.5 mm	Ø18 135.5 mm	
Housing material	Stainless steel (1.4305) PTFE	Stainless steel (1.4305) PTFE	Stainless steel (1.4305) PTFE	
Signal type	Analog, voltage/analog, current/analog, temperature	Analog, temperature	Analog, voltage/analog, current	
Fastening detail	Diameter 18.0 mm, mounting clamps	Diameter 18.0 mm, mounting clamps	Diameter 18.0 mm, mounting clamps	
Connection slots	M12x1-Female, 5-pole, A-coded	M12x1-Female, 5-pole, A-coded	M12x1-Female, 5-pole, A-coded	
Configurable analog inputs	Thermocouple (Type J, Type K) Pt100, Pt1000, Voltage, Current	Thermocouple (Type J, Type K) Pt100, Pt1000		
Configurable analog output			Voltage, Current	
Digital inputs				
Operating voltage U _b	18...30.2 VDC	18...30.2 VDC	18...30.2 VDC	
Inputs, number				
Output current max.	1.4 A	1.4 A	1.4 A	
Additional function				
Interface	IO-Link 1.1	IO-Link 1.1	IO-Link 1.1	
Ambient temperature	-5...70 °C	-5...70 °C	-5...70 °C	
Approval/conformity	CE	CE	CE	
IP rating	IP67	IP67	IP67	



Housing material definitions:
PTFE Polytetrafluorethylene



BNI00C9 BNI IOL-717-002-E023				
Converter				
Ø18 135.5 mm				
Stainless steel (1.4305) PTFE				
Analog, voltage/analog, current/analog, temperature				
Diameter 18.0 mm, mounting clamps				
M12x1-Female, 5-pole, A-coded				
Voltage, Current, Pt100, Pt1000				
18...30.2 VDC				
IO-Link 1.1				
-5...70 °C				
CE				
IP67				





ANALOG I/O HUBS

	BNI0008 BNI IOL-710-000-K006	BNI0007 BNI IOL-709-000-K006	
Dimension	50 x 31 x 115 mm	50 x 31 x 115 mm	
Housing material	PA	PA	
Interface	IO-Link 1.0	IO-Link 1.0	
Analog inputs	4x Analog, voltage (0...10 V)	4x Analog, current (4...20 mA)	
Digital inputs	4x PNP, Type2	4x PNP, Type2	
Digital outputs	none	none	
Auxiliary interfaces	n/a	n/a	
Outputs, number	none	none	
Inputs, number	8	8	
Output current max.	n/a	n/a	
Connection slots	8x M12x1-Female, 5-pole, A-coded	8x M12x1-Female, 5-pole, A-coded	
Additional function	n/a	n/a	
Operating voltage U_b	18...30.2 VDC	18...30.2 VDC	
Ambient temperature	-5...55 °C	-5...55 °C	
IP rating	IP67	IP67	
Cycle time min.	3 ms	3 ms	
Scope of delivery	Part label (12x), Blind plugs M12 (4x), Short guide	Part label (12x), Blind plugs M12 (4x), Short guide	

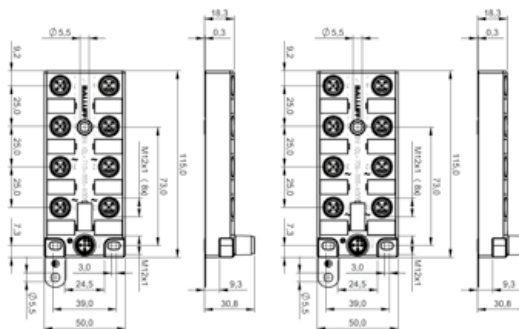



TEMPERATURE AND ANALOG I/O HUBS

	BNI100AJ BNI 10L-719-002-Z012
Dimension	68 x 31.8 x 181.5 mm
Housing material	Die-cast zinc
Interface	IO-Link 1.1
Analog inputs	8x Configurable Analog, voltage/analog, current/analog, temperature (0...10 V/-10...10 V/0...5 V/-5...5 V/5...10 V/4...20 mA/ 0...20 mA/Pt100/Pt1000/Thermocouple Type J/Thermocouple Type K)
Digital inputs	none
Digital outputs	none
Outputs, number	none
Inputs, number	8
Output current max.	n/a
Connection slots	8x M12x1-Female, 5-pole, A-coded
Additional function	n/a
Operating voltage Ub	18...30.2 VDC
Ambient temperature	-5...70 °C
IP rating	IP67
Cycle time min.	54.4 ms
Scope of delivery	Part label (20x), Blind plugs M12 (4x), Ground strap, Lock washer, Short guide, M4x6 screw

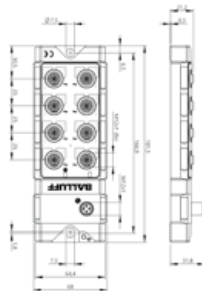



SIGNAL CONVERTER

	BNI00C1 BNI IOL-760-002-E066		
Principle of operation	Converter		
Dimension	Ø18 135.5 mm		
Housing material	Stainless steel (1.4305) PTFE		
Signal type			
Fastening detail	Diameter 18.0 mm, mounting clamps		
Connection slots	M12x1 -Female, 8-pole, A-coded		
Configurable analog inputs	none		
Configurable analog output	none		
Digital inputs	2x PNP, Type 3		
Operating voltage U_b	18...30.2 VDC		
Inputs, number	2		
Output current max.	1.4 A		
Additional function	RS232		
Interface	IO-Link 1.1		
Ambient temperature	-5...55 °C		
Approval/conformity	CE		
IP rating	IP67		



Housing material definitions:
 PP Polypropylene



MEMORY MODULE

	BN100AM BNI IOL-910-002-K060		
Dimension	34 x 16 x 8 mm		
Housing material	PP		
Connection type	Cable with connector, 0.30 m, PUR		
IO-Link function	IO-Link Memory Device		
Interface	IO-Link 1.1		
Data storage	1 kB		
Operating voltage U_b	18...30.2 VDC		
Ambient temperature	-25...70 °C		
IP rating	IP67 when threaded in		
Cycle time min	2 ms		

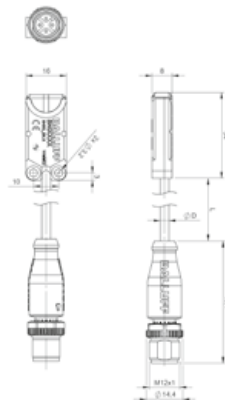



INDUCTIVE COUPLERS

	BIC0070 BIC 1B0-ITA50-Q40KFU-SM4A4A	BIC0072 BIC 1B0-IT005-Q40KFU-SM4A4A	BIC0071 BIC 2B0-ITA50-Q40KFU-SM4A5A	
Component	Base	Base	Remote	
Dimension	40 x 40 x 63 mm	40 x 40 x 63 mm	40 x 40 x 63 mm	
Style	block style	block style	block style	
Housing material	PBT	PBT	PBT	
Interface	IO-Link 1.1	IO-Link 1.1	IO-Link 1.1	
Installation	non-flush	non-flush	non-flush	
Connection	Connector, M12x1, 4-pole	Connector, M12x1, 4-pole	Connector, M12x1, 5-pole	
Function	IO-Link	IO-Link	IO-Link	
Transmission distance	0...5 mm	0...5 mm	0...5 mm	
Output voltage	24 VDC	24 VDC	24 VDC	
Rated output current	500 mA	500 mA (auto shutoff)	500 mA	
Transmission power	12 W	12 W	12 W	
Ambient temperature	-5...55 °C	-5...55 °C	-5...55 °C	
IP rating	IP67	IP67	IP67	
Approval/conformity	CE	CE	CE	

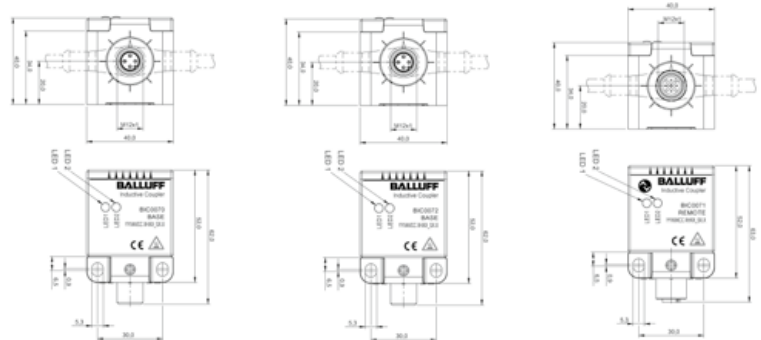

Housing material definitions:
PBT Polybuteneterephthalate



BIC007L BIC 1B0-ITA50-M30MF1-SM4A5A	BIC007E BIC 2B0-ITA50-M30MF1-SM4A5A			
Base	Remote			
M30 x 66.2 mm	M30 x 72.1 mm			
M30x1.5	M30x1.5			
Brass	Brass			
IO-Link 1.1	IO-Link 1.1			
non-flush	non-flush			
Connector, M12x1, 5-pole	Connector, M12x1, 5-pole			
IO-Link	IO-Link			
0...10 mm	0...10 mm			
24 VDC	24 VDC			
650 mA	650 mA			
15.6 W	15.6 W			
-5...55 °C	-5...55 °C			
IP67	IP67			
CE	CE			

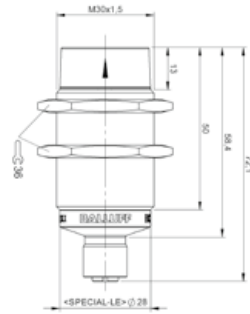
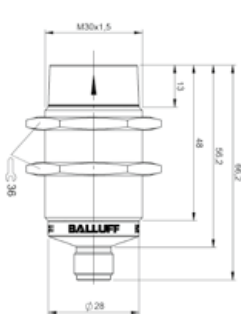
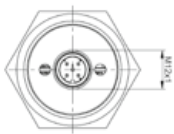



INDUCTIVE COUPLERS

	BIC0053 BIC 110-IAA50-M30MI3-SM4A4A	BIC0054 BIC 210-IAA50-M30MI3-SM4A5A	BIC005H BIC 210-IAA50-M30MI3-BPX04-002-M45A
Component	Base	Remote	Remote
Dimension	M30 x 100 mm	M30 x 106 mm	M30 x 85.5 mm
Style	M30x1.5	M30x1.5	M30x1.5
Housing material	Brass	Brass	Brass
Interface	IO-Link 1.0	IO-Link 1.0	IO-Link 1.0
Installation	non-flush	non-flush	non-flush
Connection	Connector, M12x1, 4-pole	Connector, M12x1, 5-pole	Connector, 5-pole, 0.20 m, PUR
Function	IO-Link (Input Only)	IO-Link (Input Only)	IO-Link (Input Only)
Transmission distance	0...5 mm	0...5 mm	0...5 mm
Output voltage	24 VDC	24 VDC	24 VDC
Rated output current	500 mA	500 mA	500 mA
Transmission power	12 W	12 W	12 W
Ambient temperature	-5...55 °C	-5...55 °C	-5...55 °C
IP rating	IP67	IP67	IP67
Approval/conformity	CE	CE	CE
Process Data	10 bytes Device In Zone	10 bytes Device In Zone	10 bytes Device In Zone

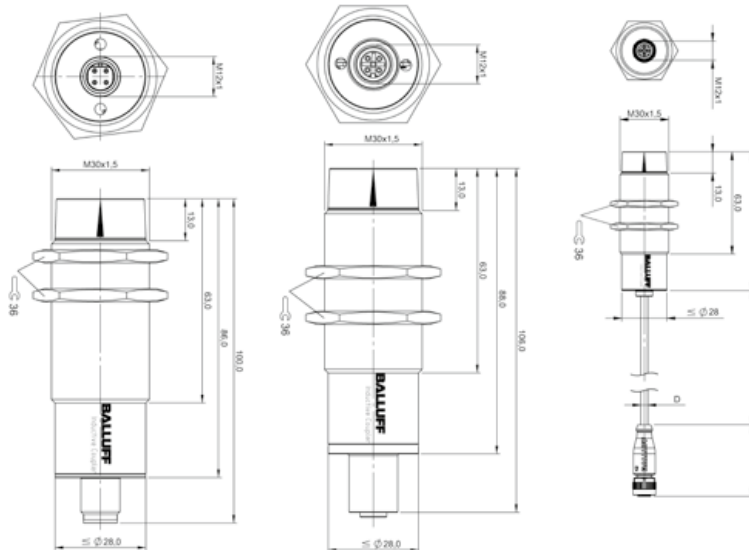

Housing material definitions:
PBT Polybuteneterephthalate

All the information you need at a glance

HUMAN MACHINE INTERFACES

 *innovating automation*

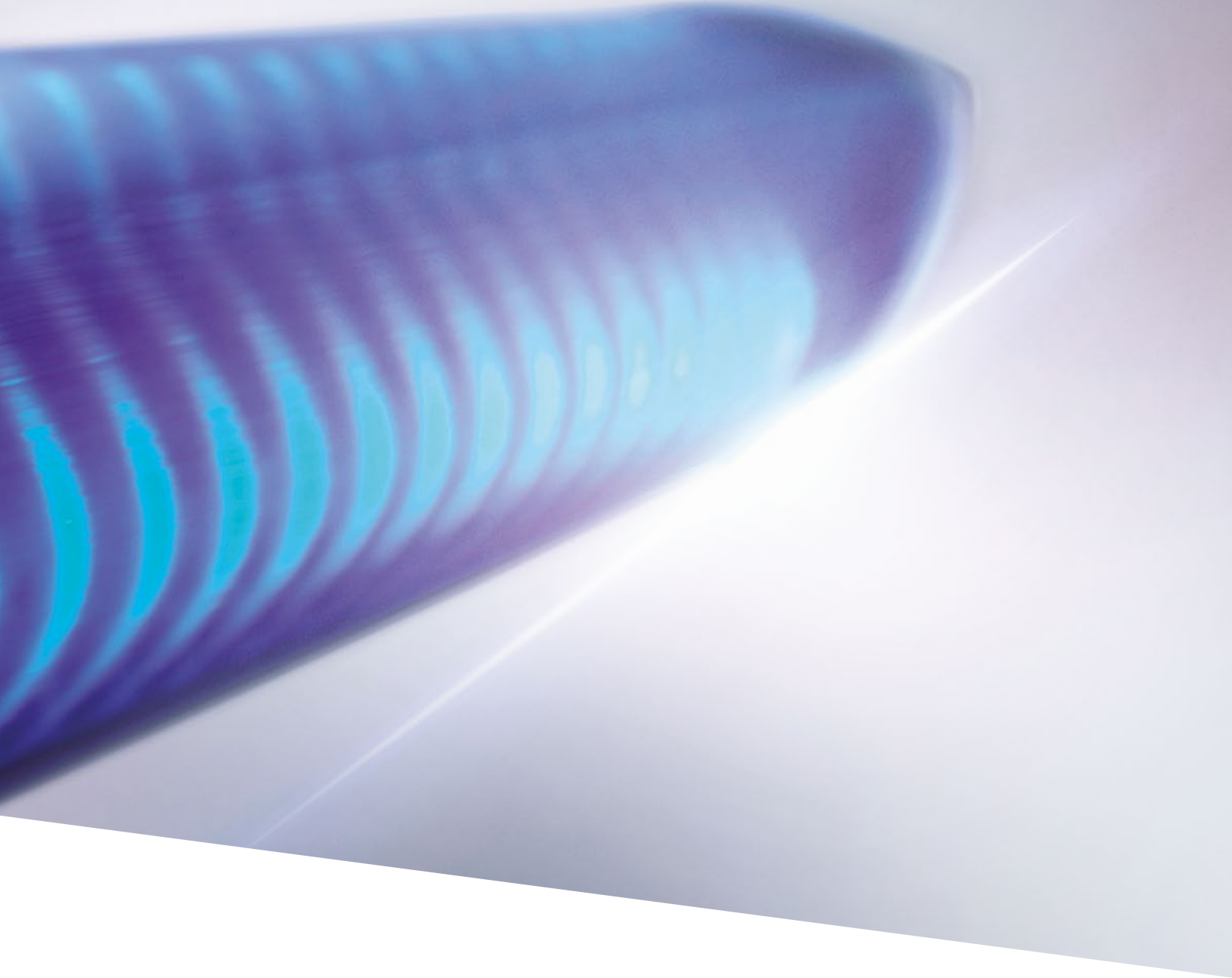

With our signaling and display devices, you know at all times what and where things stand with production and exactly where a tool is located. You can reliably monitor the state of machines and systems and display the sensor output signals.

Your Balluff solutions

- SmartLight tower lights
- SmartLight indicator



SMARTLIGHT TOWER LIGHT

	BNI0083 BNI IOL-802-000-Z037	BNI0084 BNI IOL-802-000-Z037-006	BNI0085 BNI IOL-802-102-Z037	
Dimension	60 x 60 x 330 mm	60 x 60 x 330 mm	60 x 60 x 330 mm	
Housing material	PC, transparent	PC, transparent, chrome	PC, transparent	
Fastening detail	1-hole screw mount	1-hole screw mount	1-hole screw mount	
Segments, number max.	5	5	5	
Colors, number	7	7	7	
Predefined colors	Yellow, white, green, blue, red, orange, configurable	Yellow, white, green, blue, red, orange, configurable	Yellow, white, green, blue, red, orange, configurable	
Function indicator	Run light, level indicator, stack light, flexible	Run light, level indicator, stack light, flexible	Run light, level indicator, stack light, flexible	
Display	Static, flashing, flashing freely programmable	Static, flashing, flashing freely programmable	Static, flashing, flashing freely programmable	
Buzzer function	yes	yes	yes	
Volume max.	95 dB/m	95 dB/m	95 dB/m	
IO-Link function	Device	Device	Device	
Interface	IO-Link 1.1	IO-Link 1.1	IO-Link 1.1	
Operating voltage U_b	18...30.2 VDC	18...30.2 VDC	18...30.2 VDC	
Ambient temperature	-5...50 °C	-5...50 °C	-5...50 °C	
IP rating	IP30	IP30	IP30	
Approval/conformity	CE	CE	CE, cULus	
Process data	On/off	On/off	mode select, color select, on/off	

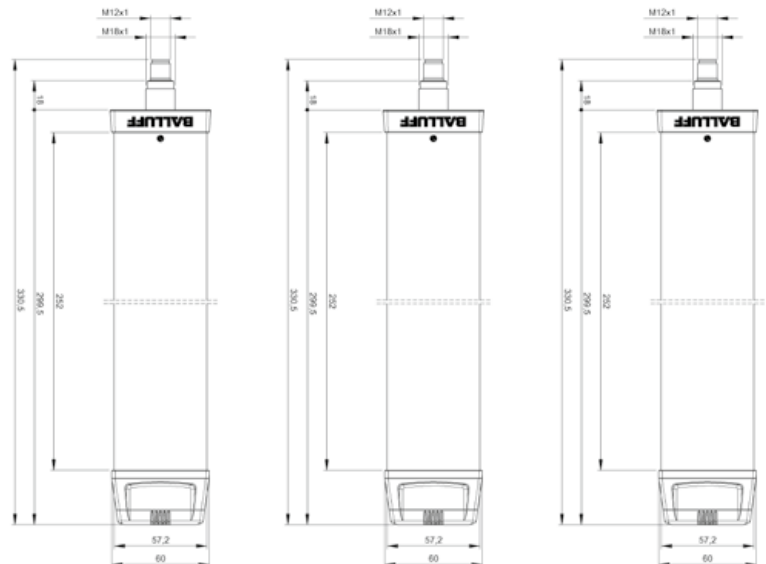

Housing material definitions:
 PC Polycarbonate



BNIO086 BNI IOL-801-000-Z037	BNIO08A BNI IOL-801-102-Z037	BNIO087 BNI IOL-800-000-Z037		
60 x 60 x 235 mm	60 x 60 x 235 mm	60 x 60 x 140 mm		
PC, transparent	PC, transparent	PC, transparent		
1-hole screw mount	1-hole screw mount	1-hole screw mount		
3	3	1		
7	7	7		
Yellow, white, green, blue, red, orange, configurable	Yellow, white, green, blue, red, orange, configurable	Yellow, white, green, blue, red, orange, configurable		
Run light, level indicator, stack light, flexible	Run light, level indicator, stack light, flexible	Run light, stack light, flexible		
Static, flashing, flashing freely programmable	Static, flashing, flashing freely programmable	Static, flashing, flashing freely programmable		
yes	yes	yes		
95 dB/m	95 dB/m	95 dB/m		
Device	Device	Device		
IO-Link 1.1	IO-Link 1.1	IO-Link 1.1		
18...30.2 VDC	18...30.2 VDC	18...30.2 VDC		
-5...50 °C	-5...50 °C	-5...55 °C		
IP30	IP30	IP30		
CE	CE, cULus	CE, cULus		
On/off	mode select, color select, on/off	On/off		

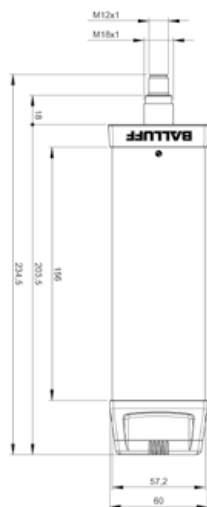
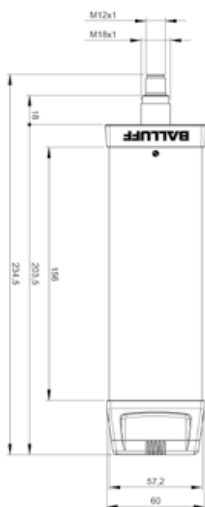



SMARTLIGHT TOWER LIGHT

	BNI0072 BNI IOL-802-000-Z036	BNI0081 BNI IOL-802-000-Z036-006	BNI0082 BNI IOL-802-102-Z036	
Dimension	60 x 60 x 310 mm	60 x 60 x 310 mm	60 x 60 x 310 mm	
Housing material	PC, Transparent	PC, Transparent, chrome	PC, Transparent	
Fastening detail	1-hole screw mount	1-hole screw mount	1-hole screw mount	
Segments, number max.	5	5	5	
Colors, number	7	7	7	
Predefined colors	Yellow, white, green, blue, red	Yellow, white, green, blue, red	Yellow, white, green, blue, red, orange, configurable	
Function indicator	Run light, level indicator, stack light, flexible	Run light, level indicator, stack light, flexible	Run light, level indicator, stack light, flexible	
Display	Static, flashing, flashing freely programmable	Static, flashing, flashing freely programmable	Static, flashing, flashing freely programmable	
Buzzer function	no	no	no	
Volume max.	none	none	none	
IO-Link function	Device	Device	Device	
Interface	IO-Link 1.1	IO-Link 1.1	IO-Link 1.1	
Operating voltage U_b	18...30.2 VDC	18...30.2 VDC	18...30.2 VDC	
Ambient temperature	-5...50 °C	-5...50 °C	-5...50 °C	
IP rating	IP65	IP65	IP65	
Approval/conformity	CE	CE	CE	
Process data	On/off	On/off	mode select, color select, on/off	

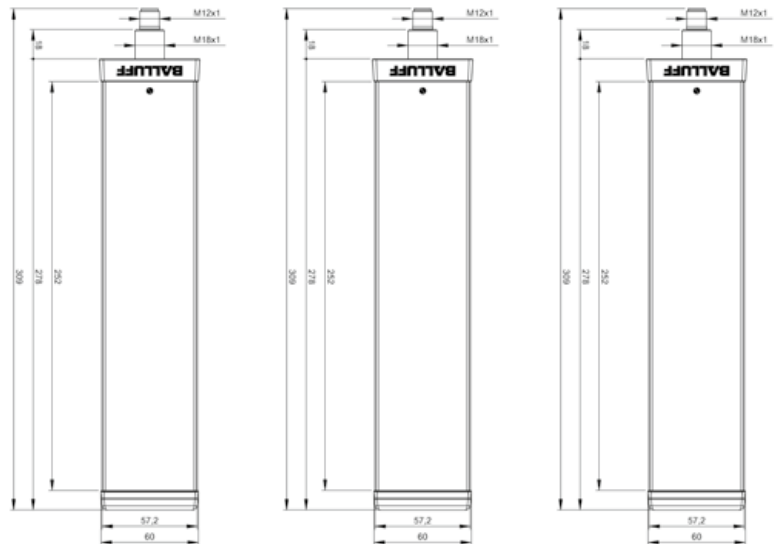

Housing material definitions:
 PC Polycarbonate



BNI007F BNI IOL-801-000-Z036	BNI0088 BNI IOL-801-102-Z036	BNI007T BNI IOL-800-000-Z036		
60 x 60 x 215 mm	60 x 60 x 215 mm	60 x 60 x 120 mm		
PC, Transparent	PC, Transparent	PC, Transparent		
1-hole screw mount	1-hole screw mount	1-hole screw mount		
3	3	1		
7	7	7		
Yellow, white, green, blue, red	Yellow, white, green, blue, red, orange, configurable	Yellow, white, green, blue, red		
Run light, level indicator, stack light, flexible	Run light, level indicator, stack light, flexible	Run light, stack light, flexible		
Static, flashing, flashing freely programmable	Static, flashing, flashing freely programmable	Static, flashing, flashing freely programmable		
no	no	no		
none	none	none		
Device	Device	Device		
IO-Link 1.1	IO-Link 1.1	IO-Link 1.1		
18...30.2 VDC	18...30.2 VDC	18...30.2 VDC		
-5...50 °C	-5...50 °C	-5...50 °C		
IP65	IP65	IP65		
CE	CE	CE		
On/off	mode select, color select, on/off	On/off		

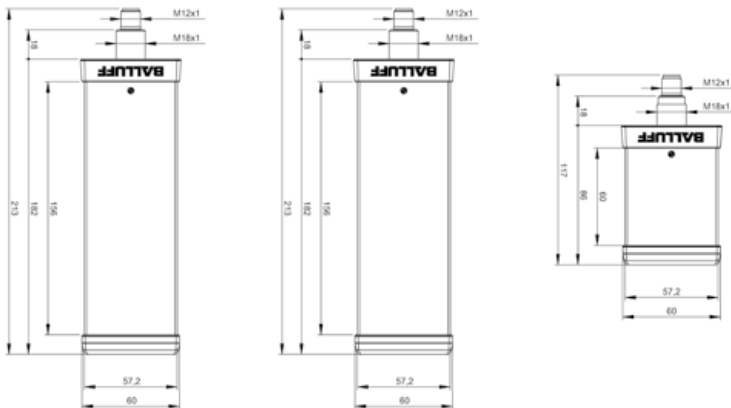

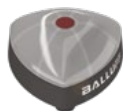

SMARTLIGHT INDICATOR

	BNI00CZ BNI IOL-803-102-R036	BNI00EO BNI IOL-803-103-R036		
Number of segments max.	6	6		
Color spectrum per segment	Red, green, yellow, blue, white	Red, green, yellow, blue, white		
Supply voltage U_b	18...30V DC	18...30V DC		
Function indicator IO-Link	Green LED or Segment 1 (Fail Safe)	Green LED or Segment 1 (Fail Safe)		
Connection: IO-Link	M12, A-coded, male	M12, A-coded, male		
Max. load current	<100 mA	<100 mA		
Degree of protection per IEC60529	IP 65	IP 65		
Operating/Storage temperature	-5...+55 °C / -15...+70 °C	-5...+55 °C / -15...+70 °C		
Mounting	M22x1 thread with key	M22x1 thread with key		
Dimension (LxWxH) mm	60x60x30	60x60x30		
Base housing material	Fortron	Fortron		
Lens material	Polycarbonate	Polycarbonate		
Sensor type	None	IR laser, time-of-flight		
Sensor range	None	100mm adjustable down		
Approval/conformity	CE, cULus	CE, cULus		
Interface	IO-Link 1.1	IO-Link 1.1		
Cycle time	7.2 ms with IO-Link 1.1 Master	7.2 ms with IO-Link 1.1 Master		
IO-Link process data length	8-byte output, 1-byte input	8-byte output, 1-byte input		

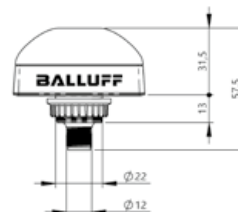
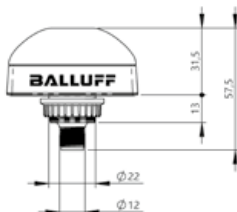
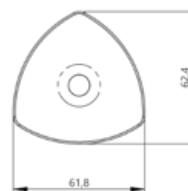
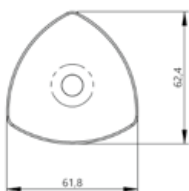

A stack of power supply units is shown, with the top unit in focus. The top unit has a silver metal casing and a black plastic component on top. The background is a gradient of blue and white, with a dark grey diagonal shape on the left side.

Wide range of voltages and power levels

POWER SUPPLIES

 *innovating automation*



With our power supplies you can power any of your applications. At Balluff you will find a wide selection of voltages and power levels for reliable and efficient power supply. Our devices are approved according to CE/TÜV, UL or CCC.

Your Balluff solutions

- IP67 machine mount power supplies
- IP20 DIN rail power supplies
- Communication adapter and signal converter

IP67 MACHINE MOUNT
POWER SUPPLIES



	BAE00TH BAE PS-XA-1W-24-038-601-I	BAE00J BAE PS-XA-1W-24-038-602-I	BAE00TK BAE PS-XA-1W-24-038-603-I	
Dimension	85.4 x 72.6 x 139 mm	85.4 x 72.6 x 139 mm	85.4 x 72.6 x 139 mm	
Version	IP67	IP67	IP67	
Fastening detail	Flange mounting	Flange mounting	Flange mounting	
Housing material	Aluminum PC	Aluminum PC	Aluminum PC	
Connection type	Cable with connector	Cable with connector	Cable with connector	
Output capacity max.	91.2 W	91.2 W	91.2 W	
Connector style	7/8" Male, 3-pole, AC M12x1 IO-Link, 7/8" Female, 4-pole, DC	7/8" Male, 3-pole, AC M12x1 IO-Link, 7/8" Female, 4-pole, DC	7/8" Male, 3-pole, AC M12x1 IO-Link, 7/8" Female, 5-pole, DC	
Input voltage	100...240 V AC, 1-phase	100...240 V AC, 1-phase	100...240 V AC, 1-phase	
Rated output voltage DC	24 V Isolated	24 V Grounded	24 V Isolated	
Rated output current	3.8 A	3.8 A	3.8 A	
Output current max.	6 A for max. 4s	6 A for max. 4s	6 A for max. 4s	
IP rating	IP67 with connector	IP67 with connector	IP67 with connector	
Approval/conformity	CE, cURus, IO-Link	CE, cURus, IO-Link	CE, cURus, IO-Link	
Ambient temperature	-25...70 °C	-25...70 °C	-25...70 °C	
For use with BNI	DeviceNet	EtherNet/IP	Prof/CC-Link	

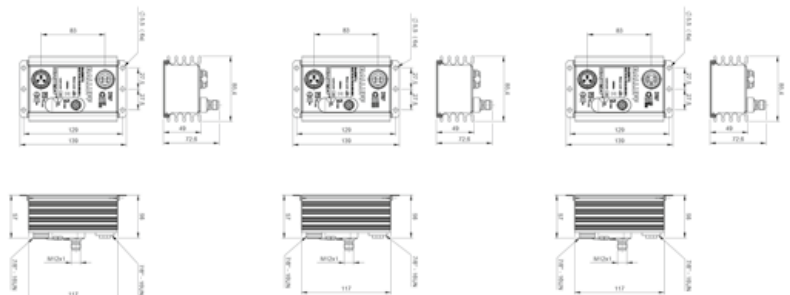

Housing material definitions:
PC Polycarbonate

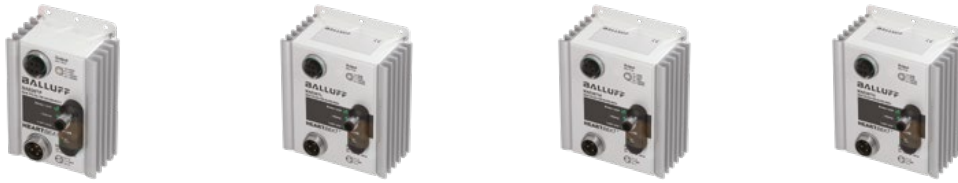

BAE00TP BAE PS-XA-1W-24-038-607-I	BAE00TL BAE PS-XA-1W-24-080-604-I	BAE00TM BAE PS-XA-1W-24-080-605-I	BAE00TN BAE PS-XA-1W-24-080-606-I	
85.4 x 72.6 x 139 mm	116 x 85 x 150 mm	116 x 85 x 150 mm	116 x 85 x 150 mm	
IP67	IP67	IP67	IP67	
Flange mounting	Flange mounting	Flange mounting	Flange mounting	
Aluminum PC	Aluminum PC	Aluminum PC	Aluminum PC	
Cable with connector	Cable with connector	Cable with connector	Cable with connector	
91.2 W	192 W	192 W	192 W	
7/8" Male, 3-pole, AC, M12x1 IO-Link, 7/8" Female, 4-pole, DC	7/8" Male, 3-pole, AC M12x1 IO-Link, 7/8" Female, 4-pole, DC	7/8" Male, 3-pole, AC M12x1 IO-Link, 7/8" Female, 5-pole, DC	7/8" Male, 3-pole, AC M12x1 IO-Link, 7/8" Female, 4-pole, DC	
100...240 V AC, 1-phase	100...240 V AC, 1-phase	100...240 V AC, 1-phase	100...240 V AC, 1-phase	
24 V Isolated	24 V Isolated	24 V Isolated	24 V Grounded	
3.8 A	8 A	8 A	8 A	
6 A for max. 4s	12 A for max. 4s	12 A for max. 4s	12 A for max. 4s	
IP67 with connector	IP67 with connector	IP67 with connector	IP67 with connector	
CE, cURus, IO-Link	CE, cURus, IO-Link	CE, cURus, IO-Link	CE, cURus, IO-Link	
-25...70 °C	-25...70 °C	-25...70 °C	-25...70 °C	
EtherNet/IP	EtherNet/IP	Profi/CC-Link	EtherNet/IP	

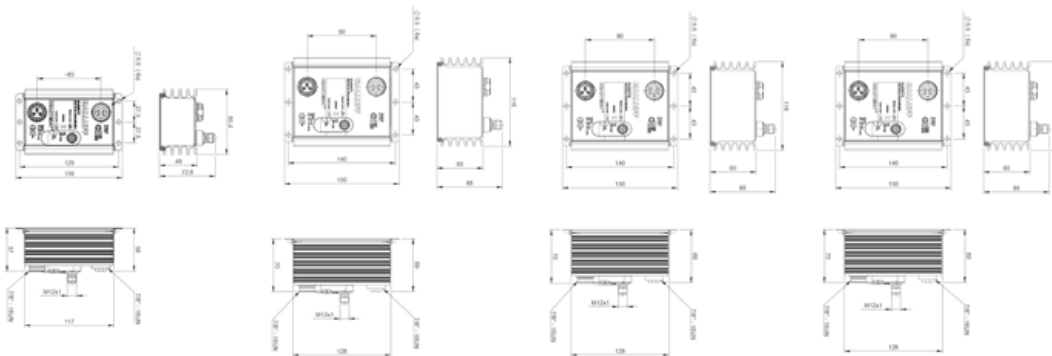

IP20 DIN RAIL
POWER SUPPLIES



	BAE00TR BAE PS-XA-1W-24-025-101	BAE00T4 BAE PS-XA-1S-24-050-102	BAE00LJ BAE PS-XA-1S-24-100-103	
Dimension	24 x 127 x 92 mm	38 x 127 x 120 mm	60 x 127 x 127 mm	
Version	DIN rail	DIN rail	DIN rail	
Fastening detail	DIN rail mount	DIN rail mount	DIN rail mount	
Housing material	Aluminum	Aluminum	Aluminum	
Connection type	Input: Terminal 2.1...2.5mm ² , Input: AWG14...AWG13, Output: Terminal 0.65...2.5mm ² , Output: AWG19...AWG13, Alarm: Terminal 0.25...1.5 mm ² , Alarm: AWG23...AWG16	Input: Terminal 2.1...2.5mm ² , Input: AWG14...AWG13, Alarm: Terminal 0.25...1.5 mm ² , Alarm: AWG23...AWG16, Output: AWG18...AWG13, Output: Terminal 0.75...2.5mm ²	Input: Terminal 2.1...2.5mm ² , Input: AWG14...AWG13, Output: terminal 1...4 mm ² , Output: AWG17...AWG11, Alarm: Terminal 0.25...1.5 mm ² , Alarm: AWG23...AWG16	
Output capacity max.	60 W	120 W	240 W	
Connector style	Terminals	Terminals	Terminals	
Input voltage	100...240 V AC, 1-phase	115/230 V AC automatic selection, 1-phase	115/230 V AC automatic selection, 1-phase	
Rated output voltage DC	24 V	24 V	24 V	
Rated output current	2.5 A	5 A	10 A	
Output current max.	3.75 A for max. 4s 1x/min.	7.5 A for max. 4s 1x/min.	15 A for max. 4s 1x/min.	
IP rating	IP20	IP20	IP20	
Approval/conformity	CE, CB, cURus, cULus	CE, CB, cURus, cULus	CE, CB, cURus, cULus	
Ambient temperature	-25...70 °C	-25...70 °C	-25...70 °C	

Require BAE00TF for IO-Link connectivity

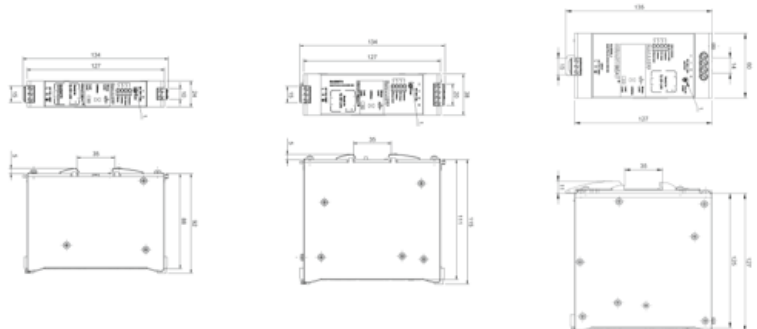



COMMUNICATION ADAPTER
AND SIGNAL CONVERTER

BAE00M3 BAE PS-XA-1S-24-200-104
79 x 127 x 139 mm
DIN rail
DIN rail mount
Aluminum
Output: AWG12... AWG11, Input: Terminal 2.1...2.5mm ² , Input: AWG14...AWG13, Alarm: Terminal 0.25...1.5 mm ² , Alarm: AWG23...AWG16, Output:Terminal 3.3...4 mm ²
480 W
Terminals
115/230 V AC automatic selection, 1-phase
24 V
20 A
30 A for max. 4s 1x/min.
IP20
CE
-25...70 °C

BAE00TF BAE SC-AE-I01	
Principle of operation	Infrared
Version	IO-Link 1.1
Application	Communication Adapter
Connection type 01	Spring clamp terminals
Use	HEARTBEAT power supplies
Material	PC
Dimension	21.5 x 24 x 10.7 mm
Fastening detail	Snap fastener
Ambient temperature	-25...70 °C
Approval/conformity	IO-Link
Process data	Output Voltage+ Current, On/off, Alarms

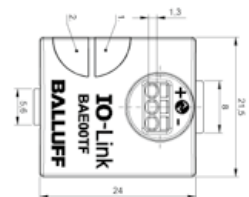
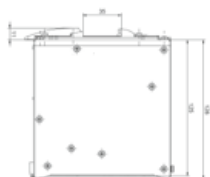
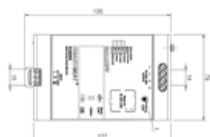

Housing material definitions:
PC – Polycarbonate

We assist you expertly and personally

SERVICES

 *innovating automation*



Meeting your specific needs

Our products are precisely tailored to your needs. Our services are too. As the leader in IO-Link technology, we provide fast commissioning, optimum process flows, cost effective solutions and the greatest possible planning security. Would you like advice on products and services? Tailor-made solutions? Or expert know-how on site? We are here to give you our comprehensive support – expert, uncomplicated and totally according to your specifications.

Your Balluff solutions

- Technical support
- Training
- Support and consultation
- Development and integration
- Product-accompanying services
- Customer-specific solutions



REFERENCES

Our complete commitment is to the success of our customers. We draw on future-looking technologies, market-oriented solutions and the expertise of an experienced manufacturer to increase your competitiveness. This is why leading companies worldwide trust in Balluff solutions.

We work together with such companies as:

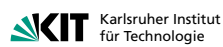

206 | Product order code index

Order code	Part number	Page
BAE		
BAE00LC	BAE SA-CS-027-YI-BP00,3-GS04	85
BAE00LJ	BAE PS-XA-1S-24-100-103	200
BAE00M3	BAE PS-XA-1S-24-200-104	201
BAE00T4	BAE PS-XA-1S-24-050-102	200
BAE00TF	BAE SC-AE-I01	201
BAE00TH	BAE PS-XA-1W-24-038-601-I	198
BAE00TJ	BAE PS-XA-1W-24-038-602-I	198
BAE00TK	BAE PS-XA-1W-24-038-603-I	198
BAE00TL	BAE PS-XA-1W-24-080-604-I	199
BAE00TM	BAE PS-XA-1W-24-080-605-I	199
BAE00TN	BAE PS-XA-1W-24-080-606-I	199
BAE00TP	BAE PS-XA-1W-24-038-607-I	199
BAE00TR	BAE PS-XA-1W-24-025-101	200
BAW		
BAW002F	BAW M18MI-BLC50B-S04G	66
BAW003A	BAW Z01AC-BLD50B-DP03	67
BAW003W	BAW Z05AC-BLD50B-BP00,75-GS04	67
BAW004M	BAW M12MI-BLC35C-S04G	66
BAW0056	BAW M12MH-BLC70G-S04G	66
BCS		
BCS011E	BCS S04K501-PICFNG-S04G-T50	82
BCS011L	BCS S04K501-PICFNG-S04G-T51	82
BCS012N	BCS R08RRE-PIM80C-EP00,3-GS04	84
BCS012P	BCS R08RRE-PIMFHC-EP00,3-GS04	83
BES		
BES04FK	BES M12MI-PSIC20C-S04G	64
BFS		
BFS000F	BFS 26K-GI-L04-S92	79
BFS000M	BFS 33M-GSI-F01-S75	79
BGL		
BGL0035	BGL 30C-007-S4	78
BGL003F	BGL 50C-007-S4	78
BIC		
BIC000C	BIC 110-I2A50-M30MI3-SM4A4A	187
BIC000E	BIC 210-I2A50-M30MI3-SM4A5A	187
BIC0053	BIC 110-IAA50-M30MI3-SM4A4A	186
BIC0054	BIC 210-IAA50-M30MI3-SM4A5A	186
BIC005A	BIC 110-I2A50-Q40KFU-SM4A4A	187
BIC005C	BIC 210-I2A50-Q40KFU-SM4A5A	187
BIC005H	BIC 210-IAA50-M30MI3-BPX04-002-M45A	186
BIC0070	BIC 1B0-ITA50-Q40KFU-SM4A4A	184
BIC0071	BIC 2B0-ITA50-Q40KFU-SM4A5A	184
BIC0072	BIC 1B0-IT005-Q40KFU-SM4A4A	184
BIC007E	BIC 2B0-ITA50-M30MF1-SM4A5A	185
BIC007L	BIC 1B0-ITA50-M30MF1-SM4A5A	185
BIP		
BIP0004	BIP LD2-T040-02-S4	69
BIP0007	BIP LD2-T014-01-EP02	68
BIP000F	BIP LD2-T014-01-EP01-S4	68
BIP001M	BIP LD2-T017-04-BP00,5-S4	68
BIS		
BIS00CZ	BIS L-409-045-001-07-S4	116
BIS00E0	BIS L-409-045-002-07-S4	116
BIS00E1	BIS L-409-045-003-07-S4	116
BIS00E2	BIS L-409-045-004-07-S4	117
BIS00LH	BIS M-400-045-001-07-S4	110
BIS00LJ	BIS M-400-045-002-07-S4	111
BIS00LK	BIS M-401-045-001-07-S4	114
BIS00LM	BIS M-451-045-001-07-S4	115
BIS00LW	BIS M-402-045-002-07-S4	112
BIS00M1	BIS M-402-045-004-07-S4	112
BIS00T3	BIS V-6102-019-C001	118
BIS00U9	BIS V-6110-063-C002	120
BIS0102	BIS M-401-072-001-07-S4	115
BIS0103	BIS M-451-072-001-07-S4	115
BIS0104	BIS M-400-072-002-07-S4	111
BIS0105	BIS M-402-072-002-07-S4	112
BIS0106	BIS M-402-072-004-07-S4	113
BIS0108	BIS M-400-072-001-07-S4	110
BIS010P	BIS V-6111-073-C003	120
BIS0122	BIS V-6106-034-C004	119
BIS0126	BIS M-402-045-007-07-S4	113

Order code	Part number	Page
BIS012E	BIS V-6102-019-C101	118
BIS012F	BIS V-6106-034-C002	118
BIS012N	BIS M-405-045-001-07-S4	113
BIS0134	BIS M-400-045-001-07-S4-SA1	110
BIS013U	BIS V-6108-048-C002	119
BIS013W	BIS V-6108-048-C102	119
BIS0146	BIS V-6106-034-C104	119
BIS0147	BIS V-6110-063-C102	120
BIS014C	BIS V-6106-034-C102	119
BIS014E	BIS V-6111-073-C103	121
BIS014J	BIS M-408-045-001-07-S4	114
BIS014K	BIS M-458-045-001-07-S4	114
BIS0155	BIS M-405-045-008-07-S4	113
BIS0157	BIS M-406-045-001-07-S4	111
BIS015R	BIS M-404-045-401-07-S4	111
BIS015T	BIS M-400-045-401-07-S4	111
BLA		
BLA0003	BLA 50A-002-S4	80
BMF		
BMF00J	BMF 203K-H-PI-C-A8-S4-00,3	86
BMF00K8	BMF 203K-H-PI-C-A8-PU-02	86
BMF00K9	BMF 203K-H-PI-C-A8-S75-00,3	86
BMF00L5	BMF 235K-H-PI-C-A8-PU-02	87
BMF00LA	BMF 235K-H-PI-C-A8-S75-00,3	87
BMF00LC	BMF 235K-H-PI-C-A8-S4-00,3	87
BML		
BML	BML TSC-ALCZ-1ZZZ-M _ _ _ _	95
BML06FU	BML SL1-ALZ0-U1ZZ-AU1L-KA05	94
BML06HC	BML SL1-ALZ0-U1ZZ-AU1L-S284	94
BML06HE	BML SL1-ALZ0-U1ZZ-ZU1L-S4	94
BNI		
BNI0005	BNI IOL-102-000-K006	151
BNI0006	BNI IOL-104-000-K006	151
BNI0007	BNI IOL-709-000-K006	180
BNI0008	BNI IOL-710-000-K006	180
BNI000P	BNI IOL-101-000-K018	154
BNI000R	BNI IOL-102-000-K019	155
BNI001E	BNI IOL-750-V02-K007	173
BNI001F	BNI IOL-750-V01-K007	172
BNI001H	BNI IOL-750-V03-K007	172
BNI001J	BNI IOL-750-V04-K007	173
BNI001K	BNI IOL-751-V01-K007	172
BNI001L	BNI IOL-751-V02-K007	173
BNI001M	BNI IOL-751-V03-K007	173
BNI001N	BNI IOL-751-V04-K007	173
BNI001W	BNI IOL-101-S01-K018	155
BNI001Y	BNI IOL-102-S01-K019	155
BNI0021	BNI IOL-104-000-K021	155
BNI0022	BNI IOL-104-S01-K021	155
BNI002Z	BNI IOL-530-000-K006	151
BNI0030	BNI PBS-504-001-K008	147
BNI0031	BNI IOL-102-000-Z012	164
BNI0032	BNI IOL-104-000-Z012	160
BNI0033	BNI IOL-252-000-Z013	128
BNI0034	BNI IOL-256-000-Z013	128
BNI0035	BNI IOL-302-000-Z013	163
BNI0039	BNI IOL-104-S01-Z012	160
BNI003A	BNI IOL-302-S01-Z013	163
BNI003C	BNI IOL-302-S01-Z012	163
BNI003K	BNI PBS-502-001-Z001	146
BNI003P	BNI PBS-507-001-Z011	146
BNI003T	BNI IOL-104-S01-Z012-C01	161
BNI003U	BNI IOL-302-000-Z012	162
BNI003W	BNI IOL-252-S01-Z013	128
BNI003Y	BNI IOL-256-S01-Z013	129
BNI0040	BNI CCL-502-100-Z001	148
BNI0041	BNI IOL-712-000-K023	177
BNI0042	BNI IOL-714-000-K023	176
BNI0043	BNI IOL-205-000-Z012	160
BNI0046	BNI IOL-302-S02-Z013	158
BNI0048	BNI IOL-302-S01-Z013-C01	164
BNI004A	BNI EIP-502-105-Z015	135
BNI004C	BNI IOL-722-000-K023	177

Order code	Part number	Page
BNI004E	BNI IOL-724-000-K023	176
BNI004K	BNI IOL-309-000-K024	157
BNI004L	BNI IOL-310-000-K025	157
BNI004N	BNI PBS-507-002-Z011	147
BNI004P	BNI PBS-504-002-K008	147
BNI004T	BNI IOL-716-000-K023	177
BNI004U	BNI PNT-502-100-Z015	140
BNI004W	BNI IOL-770-V06-A027	174
BNI0050	BNI IOL-302-000-Z026	163
BNI0051	BNI IOL-302-S01-Z026	164
BNI005A	BNI DNT-502-100-Z001	144
BNI005H	BNI PNT-508-105-Z015	138
BNI005L	BNI IOL-302-000-K006	153
BNI005M	BNI IOL-771-000-K027	175
BNI005N	BNI IOL-772-000-K027	175
BNI005P	BNI IOL-104-S01-Z012-C02	162
BNI005R	BNI PBS-502-101-Z001	146
BNI005T	BNI IOL-302-S01-K006	154
BNI005U	BNI IOL-302-000-K006-C01	153
BNI005W	BNI IOL-302-S01-K006-C01	154
BNI005Y	BNI IOL-772-000-A027	175
BNI005Z	BNI IOL-771-000-A027	174
BNI0061	BNI IOL-106-S01-Z012-C01	165
BNI0062	BNI IOL-106-S01-Z012	165
BNI0063	BNI IOL-106-000-Z012	165
BNI006A	BNI EIP-508-105-Z015	134
BNI006C	BNI PNT-502-102-Z015	139
BNI006E	BNI IOL-750-V09-K007	170
BNI006F	BNI IOL-752-V13-K007	170
BNI006H	BNI IOL-750-V11-K007	171
BNI006J	BNI IOL-750-V08-K007	168
BNI006K	BNI IOL-750-V10-K007	168
BNI006L	BNI IOL-750-V13-K007	169
BNI006M	BNI IOL-751-V09-K007	169
BNI006N	BNI IOL-751-V08-K007	168
BNI006P	BNI IOL-751-V10-K007	169
BNI006R	BNI IOL-751-V13-K007	170
BNI006T	BNI IOL-751-V11-K007	171
BNI006U	BNI IOL-752-V09-K007	171
BNI006W	BNI IOL-752-V11-K007	171
BNI006Y	BNI IOL-752-V08-K007	169
BNI006Z	BNI IOL-752-V10-K007	169
BNI0072	BNI IOL-802-000-Z036	192
BNI0074	BNI IOL-106-000-K006	152
BNI0075	BNI IOL-106-S01-K006	152
BNI0076	BNI IOL-106-S01-K006-C01	152
BNI0077	BNI ECT-508-105-Z015	142
BNI0078	BNI EIP-502-105-Z015-C05	135
BNI0079	BNI EIP-508-105-Z015-C05	135
BNI007C	BNI EIP-508-105-Z015-C06	134
BNI007E	BNI IOL-770-000-A027	174
BNI007F	BNI IOL-801-000-Z036	193
BNI007J	BNI PNT-508-105-Z031-002	139
BNI007K	BNI PNT-508-105-Z031	139
BNI007M	BNI PNT-509-105-Z033	138
BNI007P	BNI IOL-309-000-K024-001	157
BNI007R	BNI IOL-310-000-K025-001	157
BNI007T	BNI IOL-800-000-Z036	193
BNI007Y	BNI PNT-508-105-Z031-004	139
BNI007Z	BNI IOL-302-002-K006	153
BNI0080	BNI IOL-302-000-Z042	162
BNI0081	BNI IOL-802-000-Z036-006	192
BNI0082	BNI IOL-802-102-Z036	192
BNI0083	BNI IOL-802-000-Z037	190
BNI0084	BNI IOL-802-000-Z037-006	190
BNI0085	BNI IOL-802-102-Z037	190
BNI0086	BNI IOL-801-000-Z037	191
BNI0087	BNI IOL-800-000-Z037	191
BNI0088	BNI IOL-801-102-Z036	193
BNI008A	BNI IOL-801-102-Z037	191
BNI008C	BNI CIE-508-105-Z015	143
BNI008M	BNI EIP-508-105-R015	135
BNI008Z	BNI EIP-502-105-R015	135

Order code	Part number	Page	Order code	Part number	Page	Order code	Part number	Page
BN10090	BN1 IOL-104-S02-R012	156	BSP008E	BSP B050-EV002-D00S1B-S4	96	BSP00C4	BSP B002-EV002-A01S1B-S4	97
BN10091	BN1 IOL-302-S02-R026	156	BSP008F	BSP B100-EV002-D00S1B-S4	96	BSP00C5	BSP B005-EV002-A01S1B-S4	97
BN10092	BN1 PNT-507-005-Z040	140	BSP008H	BSP B250-EV002-D00S1B-S4	96	BSP00C6	BSP B010-EV002-A01S1B-S4	97
BN10093	BN1 IOL-309-002-Z019	166	BSP008J	BSP B400-EV002-D00S1B-S4	96	BSP00C7	BSP B020-EV002-A01S1B-S4	97
BN10096	BN1 EIP-508-005-E002	136	BSP008K	BSP B600-EV002-D00S1B-S4	96	BSP00C8	BSP B050-EV002-A01S1B-S4	97
BN10098	BN1 IOF-329-P02-Z038	130	BSP008L	BSP V002-EV002-A00S1B-S4	96	BSP00C9	BSP B100-EV002-A01S1B-S4	97
BN10099	BN1 IOL-102-002-Z019	166	BSP008M	BSP V010-EV002-A00S1B-S4	96	BSP00CA	BSP B250-EV002-A01S1B-S4	97
BN1009M	BN1 PNT-508-005-E002	138	BSP008N	BSP B002-EV002-A00S1B-S4	96	BSP00CC	BSP B400-EV002-A01S1B-S4	97
BN1009T	BN1 EIP-507-005-Z040	135	BSP008P	BSP B005-EV002-A00S1B-S4	96	BSP00CE	BSP B600-EV002-A01S1B-S4	97
BN1009U	BN1 ECT-507-005-Z040	142	BSP008R	BSP B010-EV002-A00S1B-S4	96	BSP00CF	BSP V002-EV003-D00S1B-S4	98
BN100A9	BN1 PNT-527-005-Z040	140	BSP008T	BSP B020-EV002-A00S1B-S4	96	BSP00CH	BSP V010-EV003-D00S1B-S4	98
BN100AA	BN1 EIP-527-005-Z040	136	BSP008U	BSP B050-EV002-A00S1B-S4	96	BSP00CJ	BSP B002-EV003-D00S1B-S4	98
BN100AC	BN1 ECT-527-005-Z040	142	BSP008W	BSP B100-EV002-A00S1B-S4	96	BSP00CK	BSP B005-EV003-D00S1B-S4	98
BN100AE	BN1 IOL-772-002-E032	175	BSP008Y	BSP B250-EV002-A00S1B-S4	96	BSP00CL	BSP B010-EV003-D00S1B-S4	98
BN100AJ	BN1 IOL-719-002-Z012	181	BSP008Z	BSP B400-EV002-A00S1B-S4	96	BSP00CM	BSP B020-EV003-D00S1B-S4	98
BN100AM	BN1 IOL-910-002-K060	183	BSP0090	BSP B600-EV002-A00S1B-S4	96	BSP00CN	BSP B050-EV003-D00S1B-S4	98
BN100AP	BN1 IOL-104-002-E012	150	BSP0091	BSP V002-EV002-A02S1B-S4	96	BSP00CP	BSP B100-EV003-D00S1B-S4	98
BN100AR	BN1 IOL-302-002-E012	150	BSP0092	BSP V010-EV002-A02S1B-S4	96	BSP00CR	BSP B250-EV003-D00S1B-S4	98
BN100AT	BN1 IOL-302-002-E013	150	BSP0093	BSP B002-EV002-A02S1B-S4	96	BSP00CT	BSP B400-EV003-D00S1B-S4	98
BN100AU	BN1 IOL-302-002-Z046	166	BSP0094	BSP B005-EV002-A02S1B-S4	96	BSP00CU	BSP B600-EV003-D00S1B-S4	98
BN100AW	BN1 IOL-311-S02-K006-C01	153	BSP0095	BSP B010-EV002-A02S1B-S4	96	BSP00CW	BSP V002-EV003-D01S1B-S4	99
BN100AZ	BN1 PNT-538-105-Z063	139	BSP0096	BSP B020-EV002-A02S1B-S4	96	BSP00CY	BSP V010-EV003-D01S1B-S4	99
BN100C1	BN1 IOL-760-002-E066	182	BSP0097	BSP B050-EV002-A02S1B-S4	96	BSP00CZ	BSP B002-EV003-D01S1B-S4	99
BN100C6	BN1 IOL-730-002-E023	178	BSP0098	BSP B100-EV002-A02S1B-S4	96	BSP00E0	BSP B005-EV003-D01S1B-S4	99
BN100C7	BN1 IOL-740-002-E023	178	BSP0099	BSP B250-EV002-A02S1B-S4	96	BSP00E1	BSP B010-EV003-D01S1B-S4	99
BN100C8	BN1 IOL-725-002-E023	178	BSP009A	BSP B400-EV002-A02S1B-S4	96	BSP00E2	BSP B020-EV003-D01S1B-S4	99
BN100C9	BN1 IOL-717-002-E023	179	BSP009C	BSP B600-EV002-A02S1B-S4	96	BSP00E3	BSP B050-EV003-D01S1B-S4	99
BN100CE	BN1 EIP-508-105-R015-007	136	BSP009E	BSP V002-EV002-A03S1B-S4	97	BSP00E4	BSP B100-EV003-D01S1B-S4	99
BN100CH	BN1 IOL-104-S02-R012-008	156	BSP009F	BSP V010-EV002-A03S1B-S4	97	BSP00E5	BSP B250-EV003-D01S1B-S4	99
BN100CJ	BN1 IOL-302-S02-R026-008	157	BSP009H	BSP B002-EV002-A03S1B-S4	97	BSP00E6	BSP B400-EV003-D01S1B-S4	99
BN100CL	BN1 IOL-355-S02-Z013	129	BSP009J	BSP B005-EV002-A03S1B-S4	97	BSP00E7	BSP B600-EV003-D01S1B-S4	99
BN100CM	BN1 IOL-302-002-Z042	158	BSP009K	BSP B010-EV002-A03S1B-S4	97	BSP00E8	BSP V002-EV003-A01S1B-S4	99
BN100CN	BN1 IOL-302-S02-Z012	158	BSP009L	BSP B020-EV002-A03S1B-S4	97	BSP00E9	BSP V010-EV003-A01S1B-S4	99
BN100CP	BN1 IOL-302-S02-Z026	159	BSP009M	BSP B050-EV002-A03S1B-S4	97	BSP00EA	BSP B002-EV003-A01S1B-S4	99
BN100CR	BN1 IOL-104-S02-Z012	159	BSP009N	BSP B100-EV002-A03S1B-S4	97	BSP00EC	BSP B005-EV003-A01S1B-S4	99
BN100CZ	BN1 IOL-803-102-R036	194	BSP009P	BSP B250-EV002-A03S1B-S4	97	BSP00EE	BSP B010-EV003-A01S1B-S4	99
BN100EO	BN1 IOL-803-103-R036	194	BSP009R	BSP B400-EV002-A03S1B-S4	97	BSP00EF	BSP B020-EV003-A01S1B-S4	99
BNS			BSP009T	BSP B600-EV002-A03S1B-S4	97	BSP00EH	BSP B050-EV003-A01S1B-S4	99
BNS04RA	BNS 819-D04-D12-100-10-FD-S4L-I	90	BSP009U	BSP V002-EV002-D01S1B-S4	97	BSP00EJ	BSP B100-EV003-A01S1B-S4	99
BNS04RM	BNS 819-D04-R12-100-10-FD-S4R-I	91	BSP009W	BSP V010-EV002-D01S1B-S4	97	BSP00EK	BSP B250-EV003-A01S1B-S4	99
BNS04T2	BNS 819-B05-D08-46-12-S4R-I	90	BSP009Y	BSP B002-EV002-D01S1B-S4	97	BSP00EL	BSP B400-EV003-A01S1B-S4	99
BNS04WF	BNS 819-D04-D16-100-10-FD-S4R-I	91	BSP009Z	BSP B005-EV002-D01S1B-S4	97	BSP00EM	BSP B600-EV003-A01S1B-S4	99
BNS0510	BNS 819-D04-D12-62-10-FD-S4L-I	90	BSP00A0	BSP B010-EV002-D01S1B-S4	97	BSP00EN	BSP V002-EV003-A03S1B-S4	99
BOD			BSP00A1	BSP B020-EV002-D01S1B-S4	97	BSP00EP	BSP V010-EV003-A03S1B-S4	99
BOD0012	BOD 63M-LI06-S4	77	BSP00A2	BSP B050-EV002-D01S1B-S4	97	BSP00ER	BSP V010-EV003-A03S1B-S4	99
BOD0020	BOD 23K-LI01-S4	76	BSP00A3	BSP B100-EV002-D01S1B-S4	97	BSP00ET	BSP B005-EV003-A03S1B-S4	99
BOD0023	BOD 24K-LI04-S92	76	BSP00A4	BSP B250-EV002-D01S1B-S4	97	BSP00EU	BSP B010-EV003-A03S1B-S4	99
BOD0026	BOD 24K-LI05-S92	76	BSP00A5	BSP B400-EV002-D01S1B-S4	97	BSP00EW	BSP B020-EV003-A03S1B-S4	99
BOS			BSP00A6	BSP B600-EV002-D01S1B-S4	97	BSP00EY	BSP B020-EV003-A03S1B-S4	99
BOS016J	BOS 23K-GI-RE10-S4	71	BSP00A7	BSP V002-EV003-A02S1B-S4	98	BSP00EZ	BSP B100-EV003-A03S1B-S4	99
BOS016T	BOS 23K-GI-RR10-S4	75	BSP00A8	BSP V010-EV003-A02S1B-S4	98	BSP00F0	BSP B250-EV003-A03S1B-S4	99
BOS0171	BOS 23K-GI-RD10-S4	72	BSP00A9	BSP B002-EV003-A02S1B-S4	98	BSP00F1	BSP B400-EV003-A03S1B-S4	99
BOS017A	BOS 23K-GI-RH10-S4	74	BSP00AA	BSP B005-EV003-A02S1B-S4	98	BSP00F2	BSP B600-EV003-A03S1B-S4	99
BOS01JJ	BOS 50K-PI-RD11-S4	73	BSP00AC	BSP B010-EV003-A02S1B-S4	98	BSP00LP	BSP B010-HV002-D00S1B-S4-001	104
BOS01UA	BOS 18M-PI-RD30-S4	72	BSP00AE	BSP B020-EV003-A02S1B-S4	98	BSP00LR	BSP V050-HV002-D00S1B-S4-001	104
BOS01UC	BOS 18M-PI-RE30-S4	70	BSP00AF	BSP B050-EV003-A02S1B-S4	98	BSP00PJ	BSP V002-DV004-D06S1A-S4	100
BOS01UE	BOS 18M-PI-PR30-S4	75	BSP00AH	BSP B100-EV003-A02S1B-S4	98	BSP00PK	BSP V010-DV004-D06S1A-S4	100
BOS01UF	BOS 18M-XI-RS30-S4	71	BSP00AJ	BSP B250-EV003-A02S1B-S4	98	BSP00PL	BSP B002-DV004-D06S1A-S4	100
BOS01UT	BOS 23K-XI-RS11-S4	71	BSP00AK	BSP B400-EV003-A02S1B-S4	98	BSP00PM	BSP B005-DV004-D06S1A-S4	100
BOS023E	BOS 18E-PI-RD30-S4	72	BSP00AL	BSP B600-EV003-A02S1B-S4	98	BSP00PN	BSP B010-DV004-D06S1A-S4	100
BOS023F	BOS 18E-PI-PR30-S4	75	BSP00AM	BSP V002-EV003-A00S1B-S4	98	BSP00PP	BSP B020-DV004-D06S1A-S4	100
BOS023H	BOS 18E-PI-RE30-S4	70	BSP00AN	BSP V010-EV003-A00S1B-S4	98	BSP00PR	BSP B050-DV004-D06S1A-S4	100
BOS023J	BOS 18E-XI-RS30-S4	70	BSP00AP	BSP B002-EV003-A00S1B-S4	98	BSP00PT	BSP B100-DV004-D06S1A-S4	100
BOS0246	BOS 08E-PI-KH22-00,2-S49	74	BSP00AR	BSP B005-EV003-A00S1B-S4	98	BSP00PU	BSP B250-DV004-D06S1A-S4	100
BOS0247	BOS 08E-PI-KH22-S49	74	BSP00AT	BSP B010-EV003-A00S1B-S4	98	BSP00PW	BSP B400-DV004-D06S1A-S4	100
BOS026R	BOS 21M-UUI-RP30-S4	81	BSP00AU	BSP B020-EV003-A00S1B-S4	98	BSP00PY	BSP B600-DV004-D06S1A-S4	100
BSP			BSP00AW	BSP B050-EV003-A00S1B-S4	98	BSP00PZ	BSP V002-DV004-D05S1A-S4	102
BSP0086	BSP V002-EV002-D00S1B-S4	96	BSP00AY	BSP B100-EV003-A00S1B-S4	98	BSP00R0	BSP V010-DV004-D05S1A-S4	102
BSP0087	BSP V010-EV002-D00S1B-S4	96	BSP00AZ	BSP B250-EV003-A00S1B-S4	98	BSP00R1	BSP B002-DV004-D05S1A-S4	102
BSP0088	BSP B002-EV002-D00S1B-S4	96	BSP00C0	BSP B400-EV003-A00S1B-S4	98	BSP00R2	BSP B005-DV004-D05S1A-S4	102
BSP0089	BSP B005-EV002-D00S1B-S4	96	BSP00C1	BSP B600-EV003-A00S1B-S4	98	BSP00R3	BSP B010-DV004-D05S1A-S4	102
BSP008A	BSP B010-EV002-D00S1B-S4	96	BSP00C2	BSP V002-EV002-A01S1B-S4	97	BSP00R4	BSP B020-DV004-D05S1A-S4	102
BSP008C	BSP B020-EV002-D00S1B-S4	96	BSP00C3	BSP V010-EV002-A01S1B-S4	97	BSP00R5	BSP B050-DV004-D05S1A-S4	102

208 | Product order code index

Order code	Part number	Page
BSP00R6	BSP B100-DV004-D05S1A-S4	102
BSP00R7	BSP B250-DV004-D05S1A-S4	102
BSP00R8	BSP B400-DV004-D05S1A-S4	102
BSP00R9	BSP B600-DV004-D05S1A-S4	102
BSP00RA	BSP V002-HV004-D05S1A-S4	103
BSP00RC	BSP V010-HV004-D05S1A-S4	103
BSP00RE	BSP B002-HV004-D05S1A-S4	103
BSP00RF	BSP B005-HV004-D05S1A-S4	103
BSP00RH	BSP B010-HV004-D05S1A-S4	103
BSP00RJ	BSP B020-HV004-D05S1A-S4	103
BSP00RK	BSP B050-HV004-D05S1A-S4	103
BSP00RL	BSP B100-HV004-D05S1A-S4	103
BSP00RM	BSP B250-HV004-D05S1A-S4	103
BSP00RN	BSP B400-HV004-D05S1A-S4	103
BSP00RP	BSP B600-HV004-D05S1A-S4	103
BSP00RR	BSP V002-HV004-D06S1A-S4	101
BSP00RT	BSP V010-HV004-D06S1A-S4	101
BSP00RU	BSP B002-HV004-D06S1A-S4	101
BSP00RW	BSP B005-HV004-D06S1A-S4	101
BSP00RY	BSP B010-HV004-D06S1A-S4	101
BSP00RZ	BSP B020-HV004-D06S1A-S4	101
BSP00T0	BSP B050-HV004-D06S1A-S4	101
BSP00T1	BSP B100-HV004-D06S1A-S4	101
BSP00T2	BSP B250-HV004-D06S1A-S4	101
BSP00T3	BSP B400-HV004-D06S1A-S4	101
BSP00T4	BSP B600-HV004-D06S1A-S4	101
BSP00T5	BSP V002-FV004-D06S1A-S4	100
BSP00T6	BSP V010-FV004-D06S1A-S4	100
BSP00T7	BSP B002-FV004-D06S1A-S4	100
BSP00T8	BSP B005-FV004-D06S1A-S4	100
BSP00T9	BSP B010-FV004-D06S1A-S4	100

Order code	Part number	Page
BSP00TA	BSP B020-FV004-D06S1A-S4	100
BSP00TC	BSP B050-FV004-D06S1A-S4	100
BSP00TE	BSP B100-FV004-D06S1A-S4	100
BSP00TF	BSP B250-FV004-D06S1A-S4	100
BSP00TH	BSP B400-FV004-D06S1A-S4	100
BSP00TJ	BSP B600-FV004-D06S1A-S4	100
BSP00TK	BSP V002-FV004-D05S1A-S4	102
BSP00TL	BSP V010-FV004-D05S1A-S4	102
BSP00TM	BSP B002-FV004-D05S1A-S4	102
BSP00TN	BSP B005-FV004-D05S1A-S4	102
BSP00TP	BSP B010-FV004-D05S1A-S4	102
BSP00TR	BSP B020-FV004-D05S1A-S4	102
BSP00TT	BSP B050-FV004-D05S1A-S4	102
BSP00TU	BSP B100-FV004-D05S1A-S4	102
BSP00TW	BSP B250-FV004-D05S1A-S4	102
BSP00TY	BSP B400-FV004-D05S1A-S4	102
BSP00TZ	BSP B600-FV004-D05S1A-S4	102
BSP00U0	BSP V002-KV004-D05S1A-S4	103
BSP00U1	BSP V010-KV004-D05S1A-S4	103
BSP00U2	BSP B002-KV004-D05S1A-S4	103
BSP00U3	BSP B005-KV004-D05S1A-S4	103
BSP00U4	BSP B010-KV004-D05S1A-S4	103
BSP00U5	BSP B020-KV004-D05S1A-S4	103
BSP00U6	BSP B020-KV004-D05S1A-S4	103
BSP00U7	BSP B100-KV004-D05S1A-S4	103
BSP00U8	BSP B250-KV004-D05S1A-S4	103
BSP00U9	BSP B400-KV004-D05S1A-S4	103
BSP00UA	BSP B600-KV004-D05S1A-S4	103
BSP00UC	BSP V002-KV004-D06S1A-S4	101
BSP00UE	BSP V010-KV004-D06S1A-S4	101
BSP00UF	BSP B002-KV004-D06S1A-S4	101

Order code	Part number	Page
BSP00UH	BSP B005-KV004-D06S1A-S4	101
BSP00UJ	BSP B010-KV004-D06S1A-S4	101
BSP00UK	BSP B020-KV004-D06S1A-S4	101
BSP00UL	BSP B050-KV004-D06S1A-S4	101
BSP00UM	BSP B100-KV004-D06S1A-S4	101
BSP00UN	BSP B250-KV004-D06S1A-S4	101
BSP00UP	BSP B400-KV004-D06S1A-S4	101
BSP00UR	BSP B600-KV004-D06S1A-S4	101
BSP00UT	BSP M100-ZT006-A02S1B-S4-006	104
BSP00UU	BSP M250-ZT006-A02S1B-S4-006	104
BSP00UW	BSP M500-ZT006-A02S1B-S4-006	104
BSP00UY	BSP M750-ZT006-A02S1B-S4-006	104
BSP00UZ	BSP B001-ZT006-A02S1B-S4-006	104
BSP00W0	BSP B002-ZT006-A02S1B-S4-006	104
BTL		
BTL6	BTL6-U110-MXXXX-PF-S4	92
BTL6	BTL6-U110-MXXXX-B-S4	93
BTL6	BTL6-U110-MXXXX-Z-S4	93
BTS		
BTS0002	BTS M30E0-UUI-H0001-S04G	106
BUS		
BUS0020	BUS M18M1-GPXI-02/015-S92G	88
BUS0023	BUS W18M1-GPXI-02/015-S92G	89
BUS0029	BUS M18M1-GPXI-03/025-S92G	88
BUS002A	BUS W18M1-GPXI-03/025-S92G	89
BUS004N	BUS W18M1-GPXI-12/100-S92G	89
BUS004P	BUS M18M1-GPXI-12/100-S92G	89
BUS004Y	BUS W18M1-GPXI-07/035-S92G	89
BUS004Z	BUS M18M1-GPXI-07/035-S92G	88
BVS		
BVS002A	BVS SC-M1280Z00-30-000	124

USA

Balluff Inc.
8125 Holton Drive
Florence, KY 41042
Phone: (859) 727-2200
Toll-free: 1-800-543-8390
Fax: (859) 727-4823
balluff@balluff.com

Canada

Balluff Canada, Inc.
2840 Argentia Road, Unit #2
Mississauga, Ontario L5N 8G4
Phone: (905) 816-1494
Toll-free: 1-800-927-9654
Fax: (905) 816-1411
balluff.canada@balluff.ca

Mexico

Balluff de México SA de CV
Anillo Vial II Fray Junípero Serra No. 4416
Colonia La Vista Residencial.
Querétaro, Qro. CP76232
Phone: (+52 442) 212-4882
Fax: (+52 442) 214-0536
balluff.mexico@balluff.com



www.balluff.com

HOW
TO REACH
US

CONNECTING YOUR EQUIPMENT WITH SENSORS, RFID AND I/O · 10-Link Portfolio

BALLUFF

Doc. No. 940116/Mat. No. 266485 EN -E18; subject to modification.