

System overview

1

Chain bracket

Chain bracket U-part

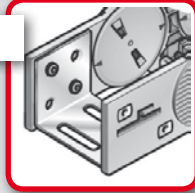

2

Shelving system

Separator TR



1

2



Guide channels

Aluminium VAW



Technical data

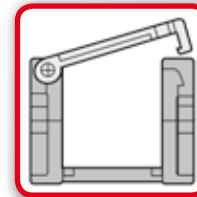

Loading side

Inside or outside flexure curve

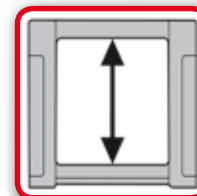

Available interior heights

18.0 mm

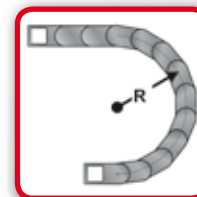

Available radii

28.0 – 78.0 mm

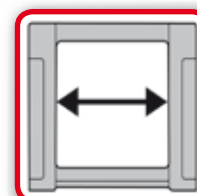

Available interior widths

15.0 – 70.0 mm

Ordering key

Type	Variation	Variation			Ridge version	Material	Chain length mm
		Inside width mm	Outside width mm	Radius mm			
0181	01 ¹⁾	15	28	28	0	0	<div style="display: flex; justify-content: space-between; align-items: center;"> <div style="text-align: center;"> <p>Ordering key</p> <div style="display: flex; gap: 10px;"> <div style="border: 1px solid black; padding: 2px;">_ _ _</div> <div style="border: 1px solid black; padding: 2px;">_ _</div> <div style="border: 1px solid black; padding: 2px;">_ _</div> <div style="border: 1px solid black; padding: 2px;">_ _ _</div> <div style="border: 1px solid black; padding: 2px;">_</div> <div style="border: 1px solid black; padding: 2px;">_</div> <div style="border: 1px solid black; padding: 2px;">_ _ _ _ _</div> </div> </div> </div>
0182	02 ²⁾	18	31	38	0	1	
		25	38	48	0	5	
		37	50	78	0	7	
		50	63		0	9	
		70	83		0		
					0		
					0		
					0		
					0		

¹⁾ for Type 0181 only
²⁾ for Type 0182 only

Chain length mm



Chain link

Loading side:

Inside or outside flexure curve

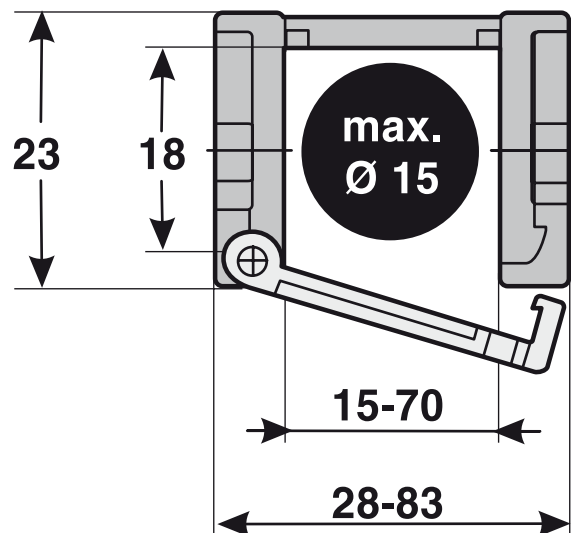

Dimensions in mm

- 0 Standard (PA/black)
- 1 UL94/V0 (PA/oxide red)
- 5 Polypropylene (PP/blue)
- 7 EMC (PA/light grey)
- 9 Special version

- 0 PA full-ridged with bias

- 01 Frame bridge on outside of radius
Frame bridge on inside of radius
Opens on outside of radius
- 02 Frame bridge on outside of radius
Frame bridge on inside of radius
Opens on inside of radius

Order sample: 0181 01 015 028 0 0 1122

Frame bridge in outside bend, frame bridge in inside bend, can be opened from outside bend
 Inside width 15 mm; radius 28 mm
 Plastic bridge, full-ridged with bias, material black-coloured polyamide
 Chain length 1122 mm (34 links)

Technical specifications

Travel distance gliding L_g max.:	20.0 m
Travel distance self-supporting L_f max.:	see diagram
Travel distance vertical, hanging L_{vh} max.:	8.0 m
Travel distance vertical, upright L_{vs} max.:	3.0 m
Rotated 90°, unsupported L_{90f} max.:	0.5 m
Speed, gliding V_g max.:	2.0 m/s
Speed, self-supporting V_f max.:	5.0 m/s
Acceleration, gliding a_g max.:	5.0 m/s ²
Acceleration, self-supporting a_f max.:	5.0 m/s ²

Material properties

Standard material:	Polyamide (PA) black
Service temperature:	-30.0 – 120.0 °C
Gliding friction factor:	0.3
Static friction factor:	0.45
Fire classification:	UL 94 HB
Other material properties on request.	

Determining the chain length

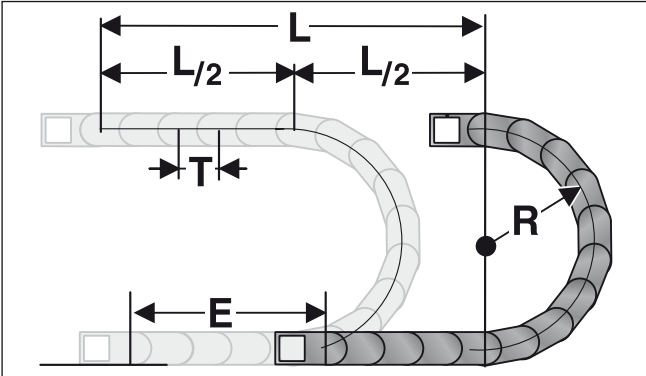

The fixed point of the cable drag chain should be connected in the middle of the travel distance. This arrangement gives the shortest connection between the fixed point and the moving consumer and thus the most efficient chain length.

$$\text{Chain length calculation} = L/2 + \pi * R + 2 * T + E$$

≈ 1 m chain = x 33.0 mm links.

E = distance between entry point and middle of travel distance
 L = travel distance
 R = radius
 P = Pitch

Self-supporting length

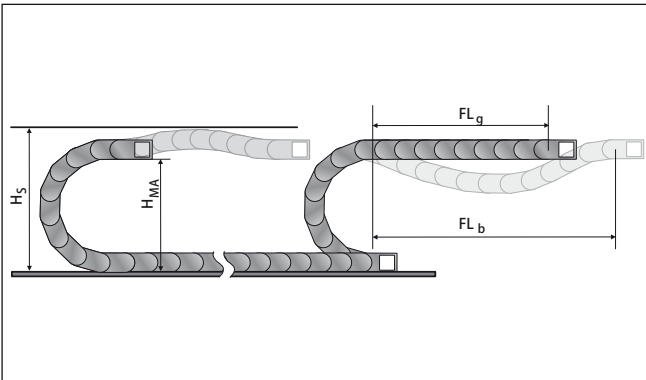

The self-supporting length is the distance between the chain bracket on the moving end and the start of the chain arch.

The installation variant FL_g offers the lowest load and wear for the cable drag chain.

The maximum travel parameters (speed and acceleration) can be applied for this variant.

H_s = Installation height plus safety
 H_{MA} = Height of moving end connection
 FL_g = Self-supporting length, upper run straight
 FL_b = Self-supporting length, upper run bent

Load diagram for self-supporting applications

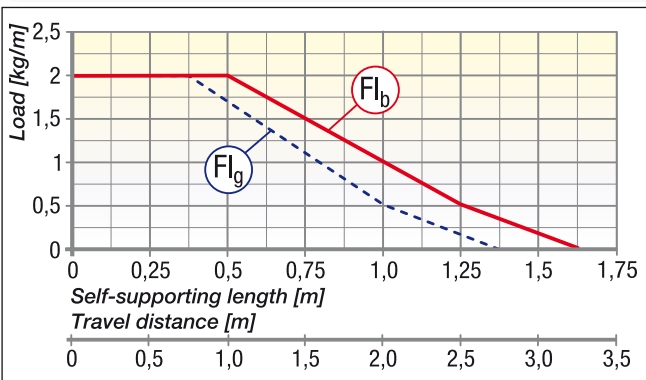

FL_g Self-supporting Length, upper run straight
 In the FL_g range, the chain upper run still has a bias, is straight or has a maximum sag of

FL_b Self-supporting Length, upper run bent
 In the FL_b range, the chain upper run has a sag of more than , but this is still less than the maximum sag. Where the sag is greater than that permitted in the FL_b range, the application is critical and should be avoided. The self-supporting length can be optimized by using a support for the upper run or a more stable cable drag chain.

Installation dimensions

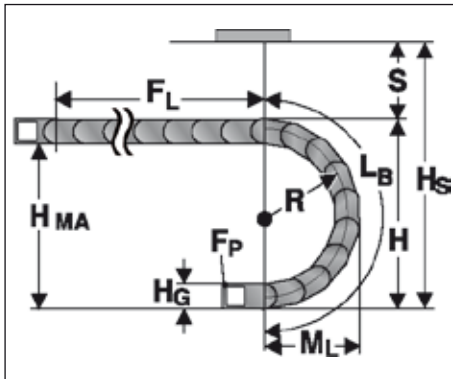

Radius R	28	38	48	78
Outside height of chain link (H_o)				
Height of bend (H)	79	99	119	179
Height of moving end connection (H_{MA})	56	76	96	156
Safety margin (S)	30	30	30	30
Installation height (H_i)	109	129	149	209
Arc projection (M_L)	73	83	93	123
Bend length (L_b)	157	188	220	314

Chain bracket U-part

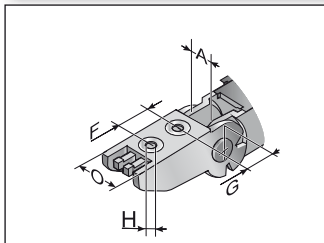

KA/Z 18015 - 025

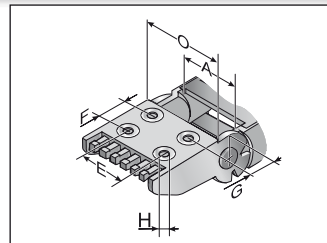

KA/Z 18037 - 070

The chain bracket is an all-plastic part with an extrusion-coated metal insert. The bracket is precisely adjusted to the respective chain width and only needs to be snapped in at the chain link. Please order one male and one female end bracket for each chain. The brackets should be fastened with M5 screws. The cables or conduits may be fastened with cable ties on the integrated strain relief of the chain bracket.

Type	Order no.	Material	Inside width					Outside width KA
			A mm	E mm	F mm	G mm	HØ mm	
KA/Z 18015 male	018100004800	Plastic	15.4		19.0	10.5	5.5	A+13.0
KA/Z 18015 female	018100004900	Plastic	15.4		19.0	8.5	5.5	A+13.0
KA/Z 18018 male	018100005000	Plastic	18.4		19.0	10.5	5.5	A+13.0
KA/Z 18018 female	018100005100	Plastic	18.4		19.0	8.5	5.5	A+13.0
KA/Z 18025 male	018100005200	Plastic	25.4		19.0	10.5	5.5	A+13.0
KA/Z 18025 female	018100005300	Plastic	25.4		19.0	8.5	5.5	A+13.0
KA/Z 18037 male	018100005400	Plastic	37.4	A-17.4	19.0	10.5	5.5	A+13.0
KA/Z 18037 female	018100005500	Plastic	37.4	A-17.4	19.0	8.5	5.5	A+13.0
KA/Z 18050 male	018100005600	Plastic	50.4	A-16.4	19.0	10.5	5.5	A+13.0
KA/Z 18050 female	018100005700	Plastic	50.4	A-16.4	19.0	8.5	5.5	A+13.0
KA/Z 18070 male	018100005800	Plastic	70.4	A-22.4	19.0	10.5	5.5	A+13.0
KA/Z 18070 female	018100005900	Plastic	70.4	A-22.4	19.0	8.5	5.5	A+13.0

Guide channels (VAW)

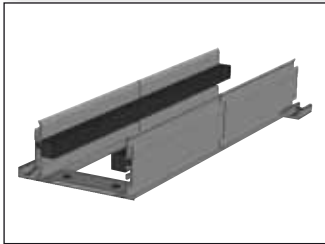

VAW

For this cable drag chain, a variable guide channel system is available, constructed from aluminium sections.

The variable guide channel ensures that the cable drag chain is supported and guided securely.

For help on choosing, please consult the chapter „Variable Guide Channel System“.

Assembly

Disassembly

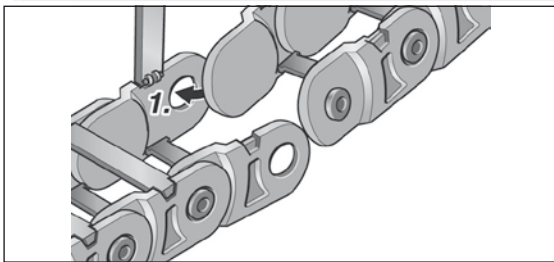

Step 1

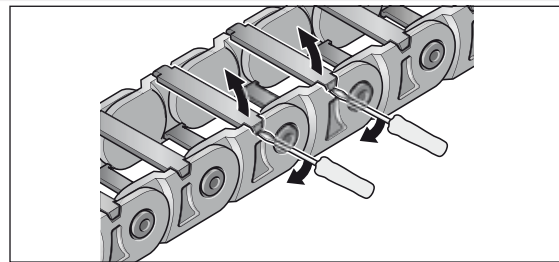

Step 1

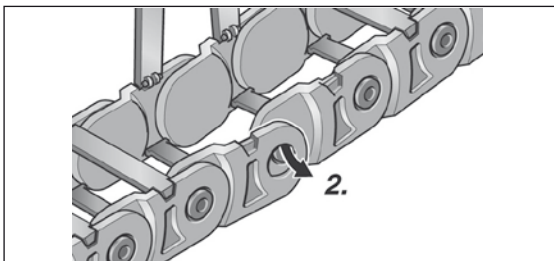

Step 2

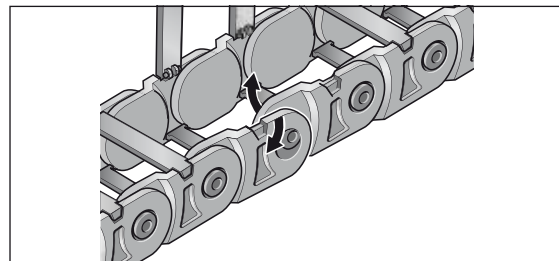

Step 2

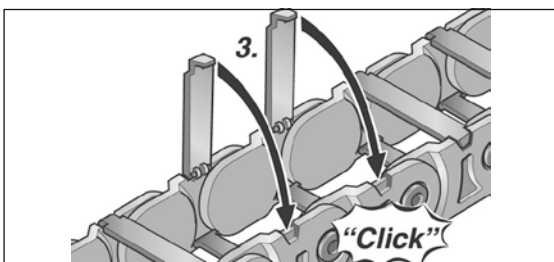

Step 3