

# Jerikom -tuotteet

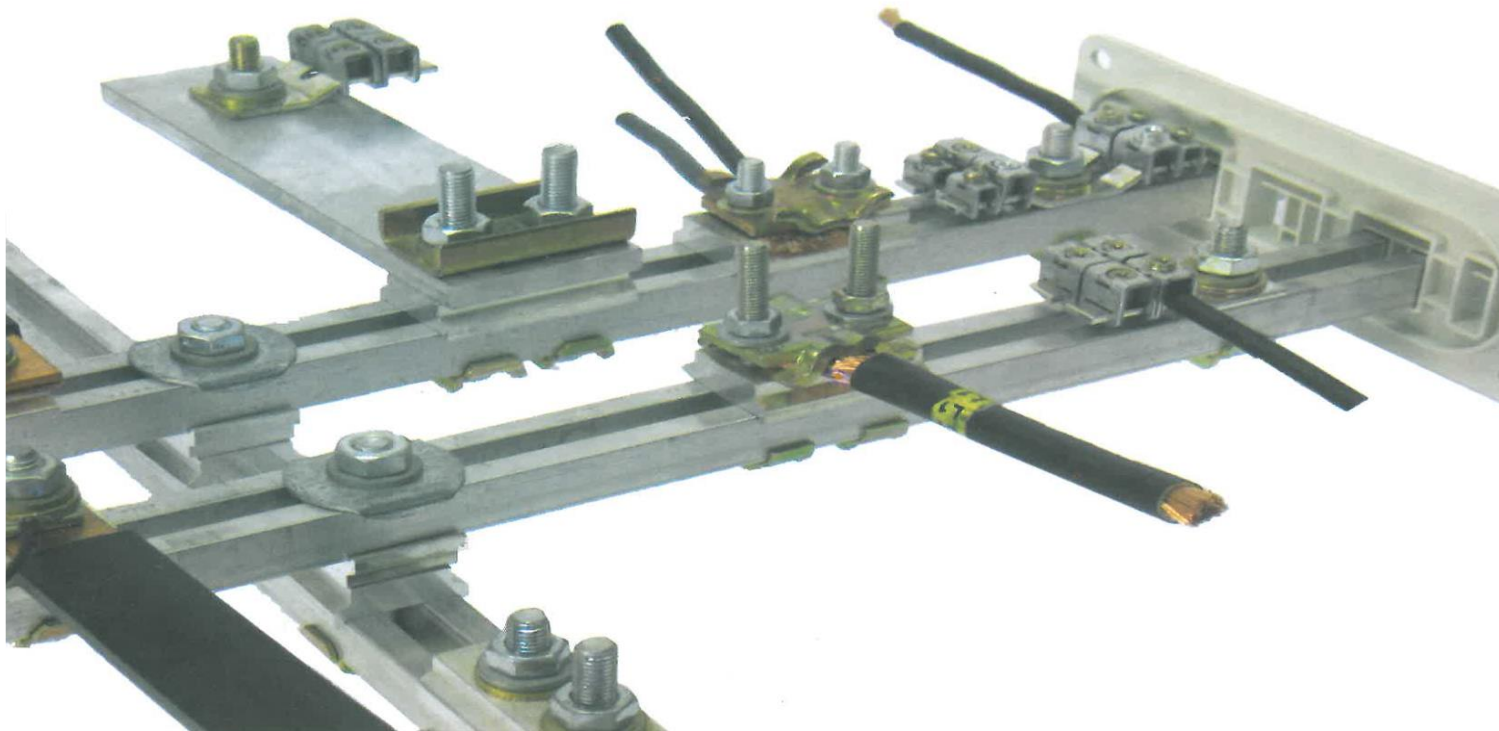









läpiviennit, laipat

Cu/Al -kiskostotarvikkeet ja -liittimet

kaapelinmerkintä tarvikkeet

Tyyppi/selite	Sstl nro	Pakkaus/laatikko
 <p>YKG22 Parikiskoliitin 2-haarainen, Ti/Cu liitinkokoonpanoon YKG18</p>	SF1917700	50
 <p>YKG22.1 Lattakiskoliitin 2-haarainen, Ti/Cu liitinkokoonpanoon YKG18.1</p>	SF1917702	50
 <p>YKG45 Kiskoliitin 4-haarainen, tinattu kupari liitinkokoonpanoon YKG17.1</p>	SF1917707	50
 <p>YKG48 Kiskoliitin 2-haarainen, toinen haara kavennettu, Ti/Cu liitinkokoonpanoon YKG52</p>	SF1917708	50
 <p>YKJ18 Tuppiliiitin, Cu1,5-16mm<sup>2</sup>, lev. 9mm</p>	SF1917721	100/1000
 <p>YKJ20 Tuppiliiitin, Cu2,5-35mm<sup>2</sup>, lev. 13mm</p>	SF1917722	200/1000

Tyyppi/selite	Sstl nro	Pakkaus/laatikko
 <p>YKG28.3 Hakavastalevy M10</p>	SF1917704	100
 <p>YKG42.2 Hakavastalevy M8</p>	SF1917705	100
 <p>YKG15 Paininlevy M10 liitinkokoonpanoon YKG7</p>	SF1917700	100
 <p>YKG23.2 Paininlevy M8 liitinkokoonpanoon YKG46.X</p>	SF1917703	100
 <p>YKG63 Liitinlevy M8 Cu 16-185mm<sup>2</sup> liitinkokoonpanoon YKG71.X</p>	SF1917716	10
 <p>YKG54.1 Johdintilan jakolevy liittimille YKG46.2 ja YKG71.2</p>		1

Tyyppi/selite	Sstl nro	Pakkaus/laatikko
 <p>YKG51/100Ti Alumiiniliitospala, tinattu 100mm</p>	SF1917709	50
 <p>YKG51/120Ti Alumiiniliitospala, tinattu 120mm</p>	SF1917710	50
 <p>YKG51/30Ti Alumiiniliitospala, tinattu 30mm</p>	SF1917711	50
 <p>YKG51/50Ti Alumiiniliitospala, tinattu 50mm</p>	SF1917712	
 <p>YKG51/52Ti Alumiiniliitospala, tinattu 52mm</p>	SF1917713	50
 <p>YKG51/60Ti Alumiiniliitospala, tinattu 60mm</p>	SF1917714	50

Tyyppi/selite	Sstl nro	Pakkaus/laatikko
 <p>YKG51/80Ti Alumiiniliitospala, tinattu 80mm</p>	SF1917715	50
 <p>YKG26 Kiskoliitin M10 liitinlevy liitinkokoonpanoon YKG25</p>	SF1917723	100
 <p>YKG27 Kiskoliitin M10 paininlevy liitinkokoonpanoon YKG25</p>	SF1917724	100
 <p>YKG47 Kiskoliitin 2*M8 800A, L ja N/PE</p>	SF1917725	50
 <p>YKG44 Paininaluslaatta, 40mm parikiskoyhdistykseen</p>	SF1917706	100
 <p>YKM11 P8 Paineentasauslaatta M8</p>	SF1917717	1000

Tyyppi/selite	Sstl nro	Pakkaus/laatikko
 <p>YKM12 P10 Paineentasauslaatta M10</p>	SF1917718	500
 <p>YKM13 J8 Joustolaatta M8</p>	SF1917719	1000
 <p>YKM14 J10 Joustolaatta M10</p>	SF1917720	500
 <p>YKI5 II kiskotukilaippa, 10*10</p>	SF3414819	120
 <p>YKI6 II kiskotukilaippa, 20*10</p>	SF3414820	120
 <p>YKI7 II kiskotukilaippa, 30*10</p>	SF3414821	120

Tyyppi/selite	Sstl nro	Pakkaus/laatikko
 <p>YKL5.1 Johdintukilaippa C-aukkoon, kiinnitysreikä 9.4mm</p>	SF3414827	200
 <p>YKL5.5 Johdintukilaippa C-aukkoon, kiinnitysreikä 5.5 mm</p>	SF3414828	200
 <p>YKM9 Pikakiinnitysnastat (4 kpl) esim. laipan YKL5.1, YKL21, YKL28 asennukseen</p>	SF3414835	100 srj
 <p>YKL6 II PG aiholaippa C-aukkoon 2xPg9/16, 1xPg11, 2xPg21/29/36</p>	SF3414829	200
 <p>YKL7 II PG aiholaippa C-aukkoon 1xPg9/16, 2xPg11, 5xPg16/21</p>	SF3414830	200
 <p>YKL11 II aiholaippa C-aukkoon 7xM12/20, 7xM16</p>	SF3414822	200

Tyyppi/selite	Sstl nro	Pakkaus/laatikko
 <p>YKL12 II aiholaippa C-aukkoon 2xM12/,2xM16, 2M20/32/50</p>	SF3414823	200
 <p>YKL13 II aiholaippa C-aukkoon 1xM12/20, 2xM16, 5xM20/32</p>	SF3414824	200
 <p>YKL14 (ennen YKI14) II umpilaippa C-aukkoon</p>	SF3414817	200
 <p>YKL27 (ennen YKI27) II PG-aihiolaippa C-aukkoon 7xPg9/16, 7xPg11, aihiot sisäpuolella</p>	SF3414818	200
 <p>YKQ3 Tiiviste C-aukkoon EPDM kumia</p>	SF3414836	1
 <p>YKL28 II kalvolaippa IP40, C-aukkoon</p>	SF3414826	120



Typpi/selite	Sstl nro	Pakkaus/laatikko
 <p>YKL21 II putkitus/kalvo kääntölaippa IP30 C-aukkoon</p>	SF3414825	120
 <p>MC3 II multilaippa IP65 RAL7035 C-aukkoon</p>	SF3414842	100
 <p>MC25 II multilaippa IP65 RAL7035, C-aukkoon</p>	SF3414843	100
 <p>MC35 II multilaippa IP65 RAL7035 C-aukkoon</p>	SF3414844	100
 <p>MC16 II kääntölaippa IP65 RAL7035, C-aukkoon</p>	SF3414845	100
 <p>MC10 II multilaippa IP65 RAL7035 C-aukkoon</p>	SF3414846	100

Tyyppi/selite	Sstl nro	Pakkaus/laatikko
 <p>MB5 I multilaippa IP65 RAL7035, B-aukkoon</p>	SF3414847	100
 <p>LMC25 II multilaippa IP54 RAL7035 C-aukkoon</p>	SF3414848	100
 <p>LMC35 II multilaippa IP54 RAL7035 C-aukkoon</p>	SF3414849	100
 <p>LMC51 II multilaippa IP54 RAL7035 C-aukkoon</p>	SF3414850	100
 <p>LMC14 II multilaippa IP54 RAL7035 C-aukkoon</p>	SF3414851	100
 <p>MC2x8-67 Halkeava kaapelipäätte C-aukkoon</p>	SF3414852	1/10

Tyyppi/selite	Sstl nro	Pakkaus/laatikko
 <p>MCLnas Lyöntinastasarja MC- ja LMC-laipoille</p>		100
<p>MSK200 (kts. Erillisesite) Kaaelinmerkintäpanta, l=158/200mm max. Kaaelin halkaisija 43mm</p>	SF6415162	50/2000
<p>MSK300 (kts. Erillisesite) Kaaelinmerkintäpanta, l=275/300mm Max. Kaaelin halkaisija 80mm</p>	SF6415163	50/800
<p>MSK AP 180 Tulostettava merkkiarkki MSK200 pannalle Arkissa 180 kpl 9*33mm liuskaa</p>	SF6415166	10
<p>MSK AP 68 Tulostettava merkkiarkki MSK300 pannalle Arkissa 68kpl 16*47mm liuskaa</p>	SF6415165	10

Taulukko 2.1

Korvaa 29.3.2005 päivätyn taulukon

**Jerikom** -kiskoliittimien johdinmäärät ja koot

Ohje on tarkoitettu tehdasmaiseen asennukseen AL- ja Cu- kiskoille.

Liitettävien johtimien tulee olla samaa johdinlajia ja enintään kolmea vierekkäistä poikkipintaa.

Ohjeita kiskojen ja johtimien liittämisestä, Al- liitostekniikasta ja taipuisista virtakiskoista annetaan käsikirjassa SFS154

Liitin 1) 2)	Nimellisvirta/A 3)		Kaapeli kenkä 5)	Johdinmäärä kpl/mm <sup>2</sup> (Cu)																	Virtakisko		Ruuvi 8.8	Johdin tilojen määrä	Kiristys momentti Nm
	Liittimen Haara	Koko Liitin 4)		1,5	2,5	4	6	10	16	25	35	50	70	95	120	150	185	240	300	Taipuisa 9)	Jäykkä 10)				
1-ruuviset																									
YKG6		400(630)	1-3	X	X	X	X	X	X	X	X	X	X	X	X	X	X	X	X	X	X	M10	35-44		
YKG6.1		250(400)	1-3	X	X	X	X	X	X	X	X	X	X	X	6)							M8	18-22		
YKG17.1	145	400(500)	1-2	Näiden haaraliittimien johdinmäärät																	X		M10	35-44	
YKG18	170	315	1-2	riippuvat käytettyjen YKJ-liittimien määrästä ja tyypistä																	X		M10	35-44	
YKG52	145, 170	315	1-2	kts. YKJ 18 ja YKJ20																	X		M10	35-44	
YKJ18		82		5	5	4	3	2	1													1			
YKJ20		135			5	5	5	4	2	1	1											1			
YKG25 7)		400(630)				8)	8)	6	6	6	4	2	2	2	2	2					X	M10	1	35-44	
2-ruuviset																									
YKG46.1		630(800)	X	7	7	7	7	7	7	5-7	5	4	3	2	2	1-2	1	1	1	X	X	M8	1	18-22	
YKG46.2		630(800)		7	7	7	7	7	7	5-7	5	4	3	2	2	1-2	1	1	1	X	X	M8	2	18-22	
YKG47		630(800)		7	7	7	7	6-7	6-7	5-6	5-6	4	3-4	2-3	2	2	1	1	1	X		M8	2	18-22	
YKG7		800(1250)		7	7	7	7	7	7	5-7	5	4-5	3	3	2	2	2	1-2	1	X	X	M10	1	35-44	
YKG71.1		630(800)	X					5-6	5	5	5	4	3	2	2	1-2	1	1		X		M8	1	18-22	
YKG71.2		630(800)						5-6	5	5	5	4	3	2	2	1-2	1	1		X		M8	2	18-22	

- 1) YK=yleiset keskustarvikkeet.
- 2) Ruuvit ja mutterit eivät sisälly (paitsi YKG47). Liittimien kokoonpano ilmenee erillisessä esitteessä.
- 3) Korkea ympäristönlämpötila, huono ilmankierto, liitostapa (johtimet kiskot) ja jäähtyvyys saattaa alentaa arvoja tai on käytettävä lämmönkestäviä johtimia.
- 4) Suluissa olevat max. arvot saavutetaan käytettäessä jäykkää tai taipusaa virtakiskoa.
- 5) Suurivirtaisin / kokoisin alimmaiseksi. Varmista kosketuspintojen yhteensopivuus ja johtimien puristuvuus.
- 6) Riippuu kaapelikengän valmistajasta ja mallista.
- 7) Paininlevy ei saa jäädä vinoon, johtimet tulee jakaa mahdollisimman tasan pultin molemmin puolin.
- 8) Pienten johtimien pysyvyys varmistettava, tarvittaessa kaksinkerroin.
- 9) Taipuisassa virtakiskon päässä on sallittu kavennus, reitys, loveus.
- 10) Jäykässä virtakiskossa yksi tai kaksi reikää.

## Ohje Jerikom liittimien asennukseen

YKM 14  
KARTIO JOUSTOLAATTA M10



YKM 12  
PAINEENTASAUSLAATTA M10



YKG 51/30 Ti  
AL-LIITOSPALA



YKG 28.3  
HAKAVASTALEVY M10



KISKOLIITIN YKG 6

YKM 13  
KARTIO JOUSTOLAATTA M8



YKM 11  
PAINEENTASAUSLAATTA M8



YKG 51/30 Ti  
AL-LIITOSPALA



YKG 42.2  
HAKAVASTALEVY M8



KISKOLIITIN YKG 6.1

YKM 14  
KARTIO JOUSTOLAATTA M10



YKM 12  
PAINEENTASAUSLAATTA M10



YKG 22  
HAARALIITIN  
KJ20 4kpl  
TUPPILOIITIN

YKG 28.3  
HAKAVASTALEVY M10



KISKOLIITIN YKG 18

YKM 14  
KARTIO JOUSTOLAATTA M10



YKM 12  
PAINEENTASAUSLAATTA M10



YKG 48  
HAARALIITIN  
KJ18 3kpl  
KJ 20 2kpl  
TUPPILOIITIN

YKG 28.3  
HAKAVASTALEVY M10



KISKOLIITIN YKG 52

YKM 14  
KARTIO JOUSTOLAATTA M10



YKM 12  
PAINEENTASAUSLAATTA M10



YKG 45  
HAARALIITIN  
KL18 4kpl  
KJ20 4kpl  
TUPPILOIITIN

YKG 28.3  
HAKAVASTALEVY M10



KISKOLIITIN YKG 17.1

YKM 14  
KARTIO JOUSTOLAATTA M10



YKG 27  
PAININLEVY M8/10



YKG 26  
LIITINLEVY



YKG 28.3  
HAKAVASTALEVY M10



KISKOLIITIN YKG 25



## Al-liitokset

Paineentasaus- ja puristuslaattojen sijoittaminen alumiinin ruuviliitokseen



### Al-liitoksen ruuvien kiristäminen

Pultin koko	M6	M8	M10	M12	M16
Kiristysmomentti [Nm]	6...9	15...22	30...44	50...75	120...190

Kiristysmomentit:

- Pienemmät arvot pehmeälle aineelle E-Al 99,5
- Isommat arvot kovalle aineelle E-AlMgSi(T6) = Al-kiskot
- Pinnoittamattoman alumiinin liitospinnat on aina harjattava ja rasvattava ennen liittämistä.