

Powerful Resistors.

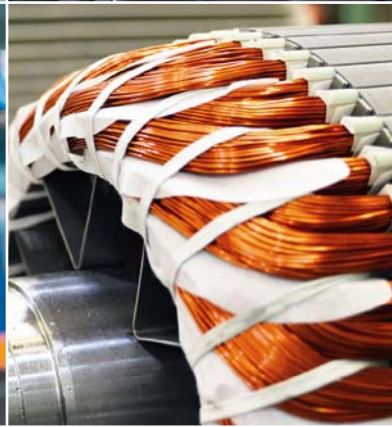

PRODUCTS



Quality workmanship with global commitment

HEINE Resistors is a medium-sized company that is rich in tradition and one of the leading experts for power resistors. For wirewound resistors, aluminium resistors, plate resistors, band resistors, load banks and neutral earthing resistors, we focus on custom solutions and the precise implementation of your requirements. HEINE stands for more than 110 years of German-made innovation and quality. We rely on strong partners, synergies and expertise internationally. This is why HEINE Resistors

is part of Microelettrica Scientifica S.p.A. and the German Knorr-Bremse Group. Our corporate values, which include dependability, commitment and vision, are more important and in greater demand today than ever before. It is not by chance that the elephant stands symbolically for HEINE Resistors. It is strong, resistant and reliable – all qualities that are close to our heart. This is why people worldwide trust in our products and the expertise of our employees. Place your trust in us!

Microelettrica Scientifica Group

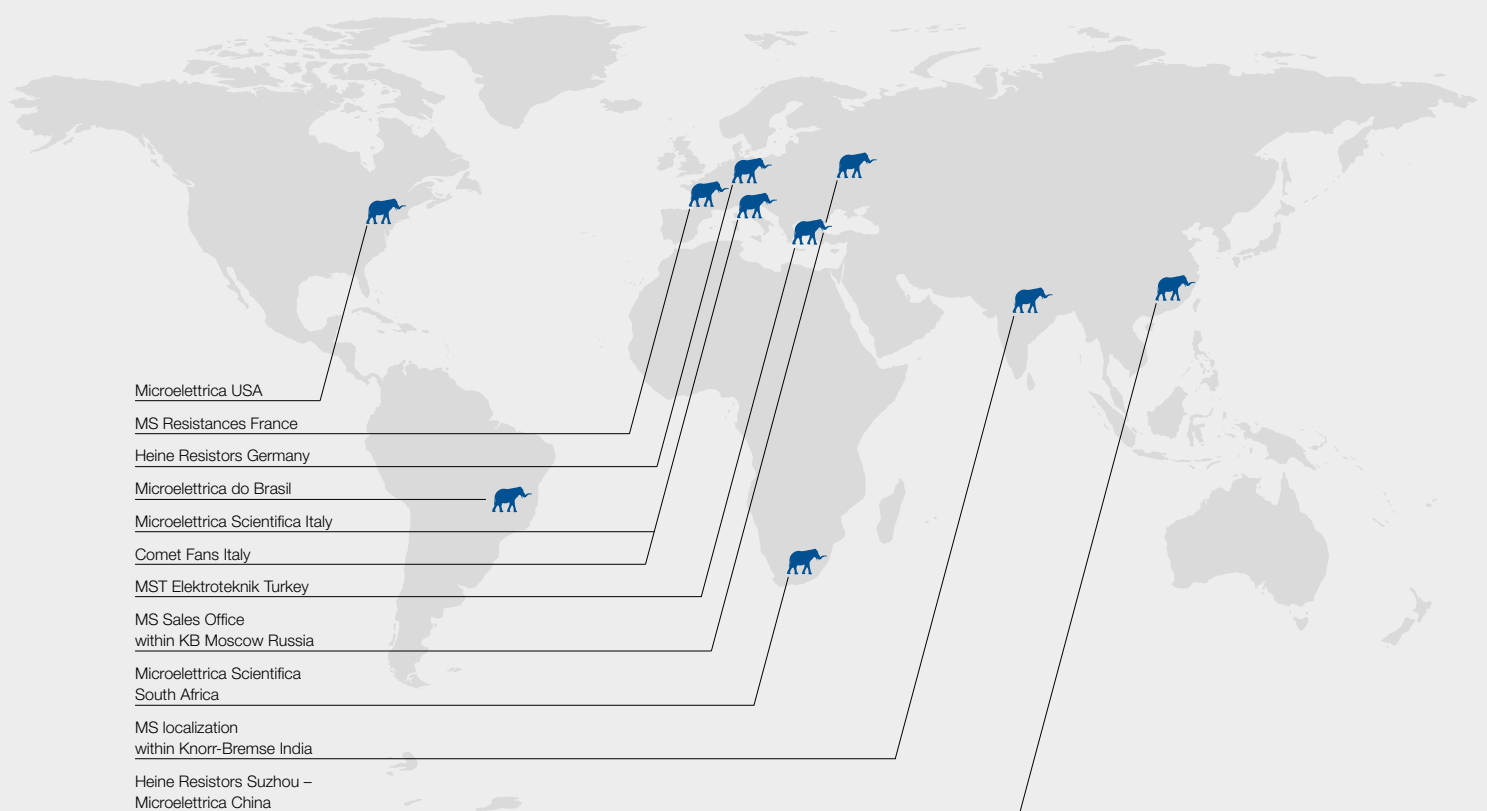

With its addition to the Microelettrica Scientifica-Group in 2012, HEINE Resistors is part of the globally operating Knorr-Bremse Group. The MS Group has several foreign subsidiaries and more than 50 local partners all over the world. This ensures a global presence.

Industries

Automation & drives

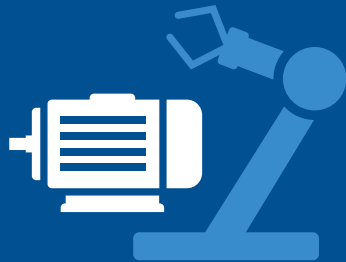

The automated production that prevails today in nearly all production sectors worldwide would be hardly imaginable without power resistors. In this area, our products include brake resistors for frequency inverters in conveyor belts, machines and robots as well as in lifts. To ensure smooth interaction with motors, we also develop charging, discharging and starting resistors.

Transport & logistics



Safety is the greatest asset in transport. This is why we manufacture brake resistors that are used daily in rail vehicles as roof, underfloor and tower resistors to bring people from A to B reliably. Our solutions in the area of crane technology and storage systems also meet the highest demands. In marine and port technology, HEINE load banks help to develop safe motors and are used in ships as brake and starting resistors.

Mechanical engineering



The design of machinery is one of the core virtues of German engineering skill and plays a significant part in the international reputation of German-made products. With our powerful and custom resistors, we help to support the guarantee of quality of mechanical engineering. Our solutions are used as brake resistors in machine tools, production machines, robots and medical technology.

Power generation



Modern power supply grids require efficiency, flexibility and, above all, safety. This is why we develop damping and earthing resistors for grid-connected systems. In addition, HEINE develops wide-ranging solutions for solar and wind energy applications, including FRT, crowbar and braking resistors for wind farms and load resistors for controlling the open-circuit voltages in solar power stations.

Plant engineering



As filter resistors, control cabinet heaters and brake resistors, our products help to improve the performance of systems and to make certain processes possible in the first place. We provide custom resistors for reliable stage equipment and lift construction. HEINE load banks and resistors are also used for testing and developing motors and generators for oil and gas extraction as well as mining.

HEINE resistor worlds

Wirewound resistor Band resistor

To ensure that laboratory technology, power supply systems, mains units and electric drives work reliably, they must be regularly tested using real resistive loads.

test

charge

Aluminium resistor Wirewound resistor

Charging and discharging resistors are used to protect capacitors in batteries.

Wirewound resistor Plate resistor

Filter resistors are used together with inductive and capacitive components to reduce undesired voltage, current and load peaks in filters.

filter

load

Wirewound resistor Band resistor Aluminium resistor

Load banks and load resistors are used in the regular load testing of motors, generators, emergency power units and battery systems to ensure their constant availability.

Resistors for any application

Wirewound resistor Plate resistor

Starting resistors are used to control the starting current of powerful motors.



Wirewound resistor Plate resistor

Earthing resistors are used to prevent damage to grid-connected systems, transformers and generators caused by short circuits between phase and earth.



brake

Wirewound resistor Aluminium resistor Plate resistor Band resistor

Brake resistors are used in a multitude of moving machines to enable the motion to be controlled reliably.

Wirewound resistors

All-rounders

Our wirewound resistors are divided into two different types: tube resistors and frame resistors.

Tube resistors are available as single-, double- and multiple-tube resistors, which indicates the flexibility of this series with a long service life. In all of these products, resistor coils are attached to ceramic tubes available in a variety of diameters. These resistors are also available in a low-induction design. Clamps that also act as electrical connections secure the resistor wire at each end of the coil. In addition, a configuration with thermal switches allows thermal monitoring.

The compact and modular design of frame resistors is impressive. Low inductivity and high insulation voltage are ensured by frames that are made of electrically insulating or metallic materials. Even if the resistor wire heats up, the absorbing and fixing properties remain intact. It is possible to use frame resistors as thermal switches for thermal monitoring and over-current relays for controlling overload events. Wirewound resistors are used as brake and chopper resistors, as series and limiting resistors and as charging, discharging and damping resistors. They can also be used as load and test resistors.

Technical data	
Resistance values	0.2–8.000 Ω
Continuous power	0.2 kW–18 kW
Protection class	IP00 – IP23

Differing specifications are available upon customer request.



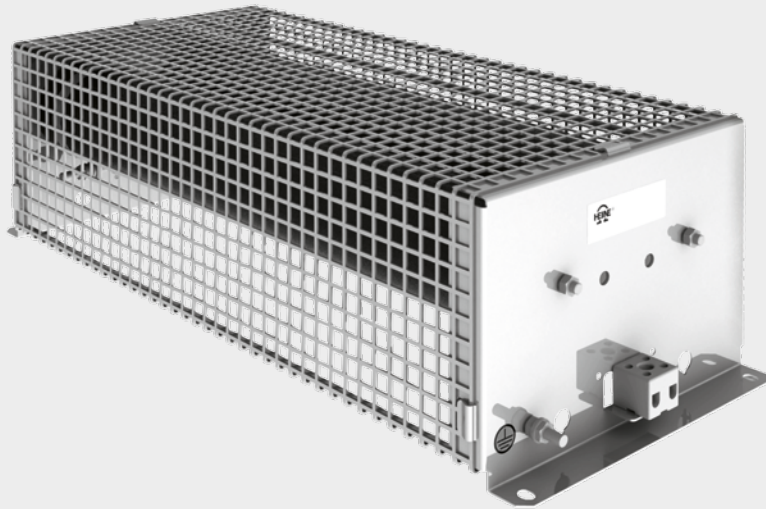
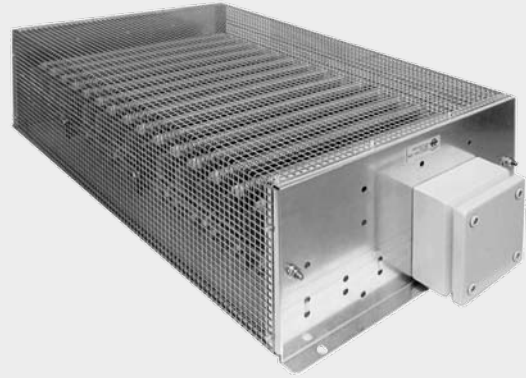
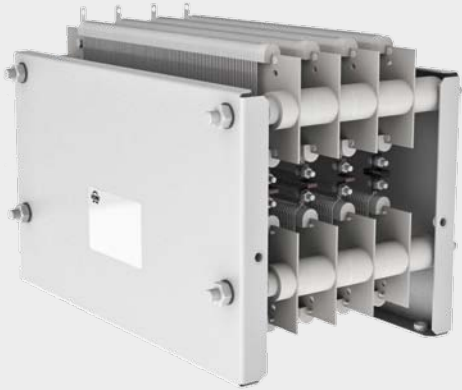

Worlds
brake
load
charge
test
start
filter
earth

Industries



Automation & drives



Mechanical engineering



Transport & logistics



Plant engineering

Aluminium resistors

Compact

This series is characterised by its combination of light weight, compact dimensions and high energy absorption capacity. It is based on either an aluminium housing (GW series) or on an aluminium profile housing with integrated

cooling fins (GWK series). By connecting multiple compact resistors in series, resistor units with higher capacities are possible. Aluminium resistors are used as brake and chopper resistors as well as load and test resistors.

Technical data	
Resistance values	2.2–1.800 Ω
Continuous power	40 W–10 kW
Protection class	IP20 – IP66

Differing specifications are available upon customer request.

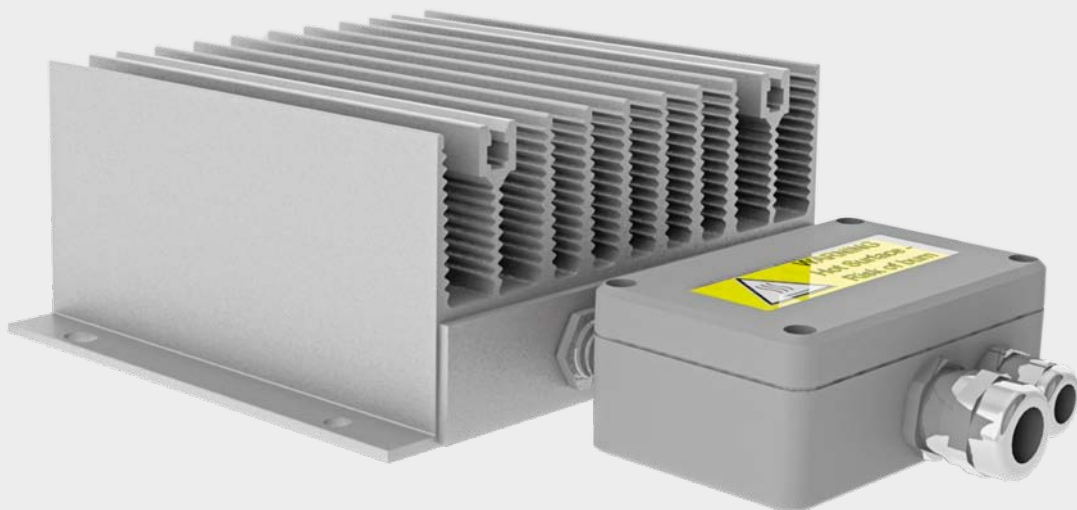

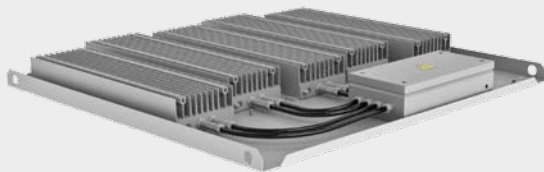
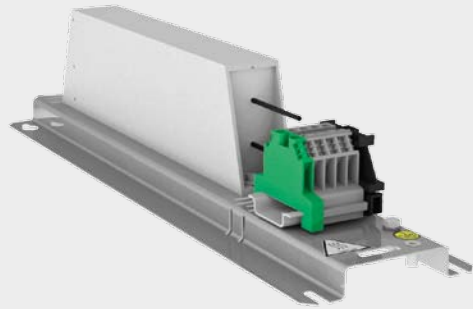
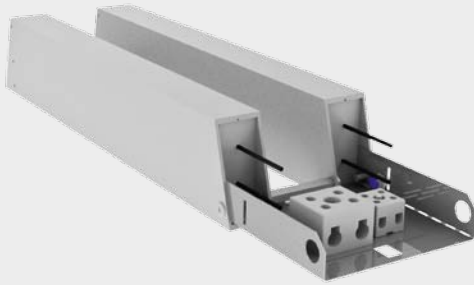

Industries



Automation & drives



Mechanical engineering



Transport & logistics



Power generation

Worlds
brake
charge
start
filter

Plate resistors

Powerful

The high energy absorption capacity of our steel grid resistors with elements made of high-alloy, heat-resistant metal panels says a great deal in their favor. Slits machined on both sides create a meander-shaped current path. The resistance value is determined by the width of the rail. The elements are reinforced with stainless steel bars and underlaid with micanite strips on both elongated sides. Up to 40 resistor elements can be installed as

required on support bolts that are insulated with mica tubes. Adjacent elements are insulated from one another via ceramic sleeves, and the current is passed on through stainless steel rolls. Plate resistors are used as brake and start resistors, as load and test resistors, as well as filter and damping resistors. The steel grid elements are used in neutral earthing resistors.

Technical data	
Resistance values	0.1 – 100 Ω
Nominal power	5 kW – 60 kW
Protection class	IP00 – IP23

Different specification available after customer request.





Industries



Automation & drives



Transport & logistics



Power generation



Plant engineering

Worlds
brake
load
test
earth

Band resistors

Large

Band resistors are manufactured specifically according to customer requirements and can reach megawatt-range capacities. In this type series, the individual resistor elements consist of longitudinally shaped band material. Depending on the individual case, a variety of resistors and stainless steel alloys with high energy absorbance capacities and rapid heat dissipation are used. Based on the customer's requirements, they can be cooled passi-

vely by convection or actively using a specially sized fan. Band resistors are available with cooling by natural convection or as force-cooled resistors and are often seen in roof resistors, underfloor resistors, and tower resistors, and used as brake and switch resistors in diesel-electrical locomotives, as brake and chopper resistors in variable speed drives, and as load and test resistors.

Technical data	
Resistance values	0.05 – 40 Ω
Continuous power	Up to 3 MW
Protection class	IP00 – IP23

Different specification available after customer request.



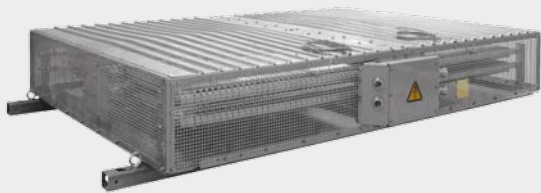

Industries



Transport & logistics



Power generation

Worlds
brake
load
test

Load banks

Robust

Robust technology and high efficiency – this characterizes our series of customer-specified load resistors and load banks. We distinguish between load resistors with a continuous power rating up to 100 kW and load banks that cover a performance range of up to 5 MW.

The resistor elements used can be made up of various types of resistors using a variety of resistance and stainless steel alloys. In general, the separate resistor units are cooled by an axial fan. Through an optional PLC controller, the separate load levels are switched on and off

based on performance. It is also possible to operate the system by remote control and to store and transmit specific data about the load bank to a distant or external control center.

With a combination of various plug-ins, the load resistors and load banks can be adapted to customer requirements and be used for testing and discharging battery systems, for electrical test in laboratories, and for carrying out load tests of motors, generators, ground power units, diesel generators, and gas turbines.

Technical data	
Nominal voltage	3x 400 VAC/50 Hz (440 and 690 VAC available upon request); DC power also available upon request
Continuous power	Up to 5 MW
Protection class	IP21 for fan and resistor IP54 for control cabinet

Differing specifications are available upon customer request.





Industries



Transport & logistics



Power generation



Plant engineering

Worlds
load
test

LBK 100kW - 5000kW

General characteristics:	
noise emission:	105 dB (A) ± 2 dB
environment temperature:	high ambient temperature operation up to 55°C
degree of protection:	IP20, IP23 resistor and fan / IP54 cabinet control
stackable when not in operation	[400 V/690 V]
stackable when in operation	[400 V]
Stainless steel finned elements	[200 V/690 V]
Low noise versions (max. 95 dB (A) ± 2 dB)	[200 V/690 V]
LBK 600i:	
Typical power factor:	0.8
Load steps:	1 kW / 1kVAr

LBK 100kW - 5000kW						
	LBK 600i 200 V	LBK 1000 400 V	LBK 2250 690 V	LBK 3000 11 kV	LBK 5000 690 V	LBK 5000 15 kV
Power [kW]	100 - 600	100 - 1000	1000 - 2250	1000 - 3000	1000 - 5000	1000 - 5000
Load steps	1/2/5/10/20/50/100/200 kW, Load level Ta ~ 40 °C					full power load-only
Voltage	3~200V/400 Hz	3~400V/50 Hz	3~400V/50 Hz 3~690V/50 Hz	3~1 kV to 11 kV	3~400V/50 Hz 3~690V/50 Hz	up to 3~15 kV
Type	reactive-resistive	resistive-only	resistive-only	resistive-only with Transformer	resistive-only	resistive-only
Enclosure	special container	stainless steel housing	10 ft. Container	20 ft. Highcube-Container	20 ft. Container	20 ft. Container
Size [mm]	L 2200 W 1410 H 1900	L 2530 W 1300 H 1200	L 2991 W 2438 H 2591	L 6058 W 2438 H 2900	L 6058 W 2438 H 2591	L 6058 W 2438 H 2591
Weight [kg]	~ 3,500	~ 1,050	~ 4,600	~ 15,000	~ 10,000	~ 10,000
Applications	Airport transformer testing with phase difference	Generator/Motor testing: ship building, oil fields, backup generators, laboratories, USV testing				



Industries



Transport & logistics



Power generation



Plant engineering

Worlds
load
test

Neutral earthing resistors

Safety conscious

When using ground fault protection which requires resistive measuring criteria it is necessary to have a higher active current, therefore a Neutral Earthing Resistor is used.

In resistance grounded networks, the resistive current component is maintained while simultaneously achieving a certain limitation of the current through the neutral point. A Neutral Earthing Resistor will have a damping effect on the neutral to ground voltage.

Neutral Earthing Resistors are also used for resistance grounding of industrial power systems. They are usually connected between the ground and the neutral point of power transformers, power generators or artificial power transformers. Their main purpose is to limit the fault to a value which will not damage generating, distributing or other associated equipment in the power system. At the same time it allows sufficient flow of fault current to operate protective relays to clear the fault.

HEINE has developed a line of standard enclosures and sizes for the most common requirements. In addition we are able to develop and manufacture Neutral Earthing Resistors after customer request and in accordance to project characteristics. Our products range from Low Voltage systems (<1 kV) to High Voltage (72,5 kV insulation class) and from very low fault current values (tens of Amps) to very high (>10 kA).

The essential parameters needed to design a Neutral Earthing Resistor are:

- Nominal Voltage
- Fault Current
- Fault Duration (10 s is customary)

Other relevant parameters are:

- Protection degree of enclosure; from IP00 - i.e. no enclosure - to IP55, standard solution IP23
- Our enclosures are standardized in galvanized or stainless steel (other steel grades possible). Painting or non-corrosive painting of the enclosure in accordance to RAL color code is possible.
- Continuous current rating; it may affect significantly the performance of the resistor especially when high IP degrees are required
- Environment and Elevation; we design resistors for the harshest industrial or natural settings
- All the standard designed Neutral Earthing Resistors can be supplied with the following equipment: Current Transformer, Voltage Transformer, Vacuum Breaker, Disconnecter and Thermostat.

Technical data

Nominal voltage	Up to 55 kV (higher voltages available upon request)
Fault current	Up to 10 kA
Protection class	IP00 – IP23 (IP55 available upon request)

Differing specifications are available upon customer request.



Industries



Automation & drives



Transport & logistics



Power generation



Plant engineering

NER up to 12 kV

available equipment combined with option box (type A2+B+C)

- Vacuum Breaker
- Current Transformer and / or Voltage Transformer
- Thermostat

Voltage	6,0 kV								6,6 kV								10,0 kV			
	A1		A2		B		C		A1		A2		B		C		A1		A2	
Width	770 mm	1070 mm	770 mm	1070 mm	770 mm	1070 mm	770 mm	1070 mm	770 mm	1070 mm	770 mm	1070 mm	770 mm	1070 mm	770 mm	1070 mm	770 mm	1070 mm	770 mm	1070 mm
max. fault current [s]																				
5 A*	125	-	∞	-	-	-	-	-	130	-	∞	-	-	-	-	-	27	∞	∞	-
10 A*	50	-	250	-	-	-	-	-	50	-	150	-	-	-	-	-	18	75	65	-
15 A*	30	90	80	-	-	-	-	-	21	65	55	-	-	-	-	-	13	45	40	-
20 A*	25	65	75	-	-	-	-	-	25	65	55	-	-	-	-	-	7,0	25	20	75
30 A*	8,0	23	20	-	150	-	-	-	8,0	30	20	-	160	-	-	-	2,0	17	14	19
40 A*	-	-	35	-	-	-	-	-	-	-	4,0	140	-	-	-	-	-	-	4,0	52
100 A	11	37	35	-	-	-	-	-	10	32	23	68	-	-	-	-	-	16	11	38
200 A	8,5	18	17	53	-	-	-	-	7,5	16	14	47	-	-	-	-	4,5	10	8,5	30
400 A	4,5	13	12	32	-	-	-	-	4,0	12	10	37	-	-	-	-	2,5	5,0	4,5	20
800 A	3,1	8,5	8,0	20	-	37	-	-	2,8	7,4	7,0	16	17	36	-	-	1,2	2,5	4,4	12
1000 A	3,5	8,0	8,0	15	-	30	-	-	2,8	7,0	7,0	15	-	28	-	40	1,5	2,0	3,5	8,8
2000 A	2,0	4,0	4,0	8,0	-	15	-	24	1,5	3,8	3,2	7,5	-	15	-	21	1,0	-	2,3	4,5
max. fault time [s] – * with 30% of fault current as continuous load																				

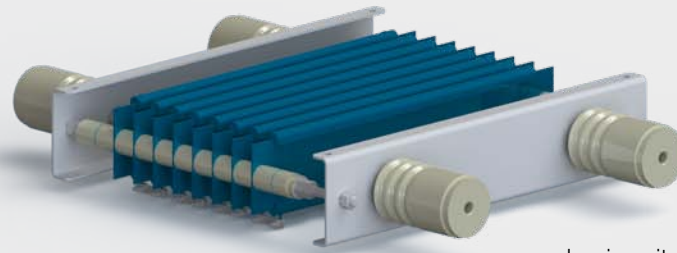

plug-in unit with frame resistor elements

Voltage	10,0 kV				11,0 kV								12,0 kV								
	B		C		A1		A2		B		C		A1		A2		B		C		
Width	770 mm	1070 mm	770 mm	1070 mm	770 mm	1070 mm	770 mm	1070 mm	770 mm	1070 mm	770 mm	1070 mm	770 mm	1070 mm	770 mm	1070 mm	770 mm	1070 mm	770 mm	1070 mm	
max. fault current [s]																					
5 A*	-	-	-	-	27	∞	200	-	-	-	-	-	-	13	120	95	-	-	-	-	-
10 A*	-	-	-	-	18	75	60	-	-	-	-	-	-	10	48	43	-	-	-	-	-
15 A*	-	-	-	-	7,5	30	38	-	-	-	-	-	-	7,0	30	26	80	-	-	-	-
20 A*	-	-	-	-	6,5	25	20	75	-	-	-	-	-	3,5	25	20	55	-	-	-	-
30 A*	80	-	-	-	1,5	12	9,0	20	38	-	-	-	-	0,5	8,0	6,0	19	25	75	-	-
40 A*	-	-	-	-	-	-	5,0	38	-	-	-	-	-	-	-	4,0	38	-	-	-	-
100 A	40	-	-	-	-	14	10	37	-	-	-	-	-	-	11	10	34	-	-	-	-
200 A	-	75	-	-	3,0	8,5	9,0	18	19	55	-	-	-	3,0	8,0	8,5	17	-	50	-	-
400 A	-	50	-	-	2,0	4,5	4,0	13	-	42	-	-	-	2,3	4,2	4,0	12	-	38	-	-
800 A	-	23	-	36	1,1	2,1	3,0	9,0	10	19	-	29	1,2	2,0	2,8	9,5	-	19	-	30	
1000 A	9,0	18	-	30	1,2	1,8	3,3	9,0	-	15	-	23	1,4	-	3,1	8,0	-	15	-	23	
2000 A	-	9,0	-	13	0,5	0,7	1,9	3,7	-	7,5	-	14	0,6	-	1,9	3,7	-	7,5	-	10	
max. fault time [s] – * with 30% of fault current as continuous load																					

Industries



Automation & drives



Transport & logistics



Power generation



Plant engineering

Worlds
earth

NER up to 24 kV

available equipment combined with option box (type A2+B+C)

- Vacuum Breaker
- Current Transformer and / or Voltage Transformer
- Thermostat

Voltage	13,8 kV								15,0 kV								20,0 kV			
	A1		A2		B		C		A1		A2		B		C		A1		A2	
Width	1070 mm	1270 mm	1070 mm	1270 mm	1070 mm	1270 mm	1070 mm	1270 mm	1070 mm	1270 mm	1070 mm	1270 mm	1070 mm	1270 mm	1070 mm	1270 mm	1070 mm	1270 mm	1070 mm	1270 mm
	max. fault current [s]																			
5 A*	28	130	220	-	-	-	-	-	27	55	200	-	-	-	-	-	-	-	90	-
10 A*	30	-	60	-	-	-	-	-	18	30	65	-	-	-	-	-	-	-	27	60
15 A*	13	30	55	-	-	-	-	-	7,5	20	38	-	-	-	-	-	-	-	17	37
20 A*	7,0	11	30	-	-	-	-	-	6,5	11	30	-	-	-	-	-	-	-	14	20
30 A*	4,0	7,0	14	20	55	-	-	-	2,0	4,5	9,0	20	38	-	-	-	-	-	3,0	10
40 A*	-	-	-	35	-	-	-	-	-	-	5,0	-	20	31	-	-	-	-	-	-
100 A	-	10	19	33	-	-	-	-	-	8,0	12	23	43	-	-	-	-	-	9,0	13
200 A	4,8	6,0	11	16	32	-	-	-	2,8	5,1	10	14	19	44	-	-	2,1	4,5	6,5	8,5
400 A	3,0	-	7,5	12	19	37	-	-	2,0	2,8	4,5	11	19	27	-	49	1,7	2,0	4,0	-
800 A	2,0	-	5,0	9,0	12	17	19	24	1,8	-	3,5	7,0	10	17	-	24	1,0	-	2,6	-
1000 A	1,6	-	3,8	7,0	9,0	15	-	22	1,5	-	3,6	7,0	9,0	12	-	19	0,8	-	2,3	-
2000 A	0,9	-	2,2	3,7	4,5	7,5	-	10	0,9	-	2,1	3,2	4,5	6,0	-	10	0,5	-	1,2	-
max. fault time [s] – * with 30% of fault current as continuous load																				

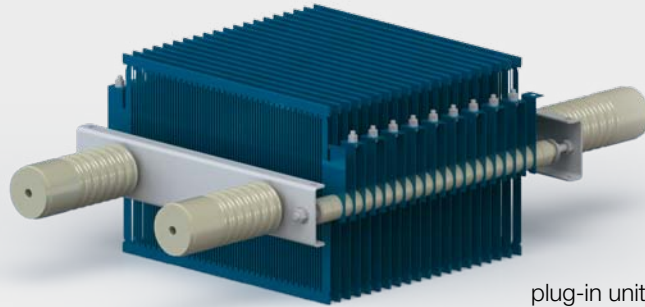

plug-in unit with steel-grid resistor elements

Voltage	20,0 kV				22,0 kV				23,0 kV											
	B		C		A1		A2		B		C		A1		A2		B		C	
Width	1070 mm	1270 mm	1070 mm	1270 mm	1070 mm	1270 mm	1070 mm	1270 mm	1070 mm	1270 mm	1070 mm	1270 mm	1070 mm	1270 mm	1070 mm	1270 mm	1070 mm	1270 mm	1070 mm	1270 mm
	max. fault current [s]																			
5 A*	-	-	-	-	-	-	45	-	-	-	-	-	-	-	50	-	-	-	-	-
10 A*	-	-	-	-	-	-	25	60	-	-	-	-	-	-	25	40	-	-	-	-
15 A*	-	-	-	-	-	-	17	26	55	-	-	-	-	-	17	26	50	-	-	-
20 A*	40	-	-	-	-	-	8,0	21	42	-	-	-	-	-	8,5	14	30	-	-	-
30 A*	-	30	-	-	-	-	2,0	6,0	20	27	38	-	-	-	1,5	5,0	20	28	38	-
40 A*	14	20	55	-	-	-	-	-	8,0	20	40	-	-	-	-	-	9,0	14	45	-
100 A	25	43	-	-	-	-	8,0	12	23	40	-	-	-	-	8,0	12	21	40	-	-
200 A	13	32	-	-	1,9	3,6	6,0	7,5	14	19	20	43	2,0	3,5	5,0	7,5	12	20	-	43
400 A	10	21	-	38	1,3	2,0	3,6	-	9,0	19	-	28	1,4	1,8	3,3	-	9,5	19	-	28
800 A	6,5	12	-	19	0,9	1,0	2,4	-	6,0	10	12	17	0,9	-	2,4	-	6,0	10	-	16
1000 A	6,5	8,5	10	15	0,7	0,8	1,9	-	6,0	9,0	-	12	0,7	-	2,0	-	6,0	9,0	-	12
2000 A	3,0	4,5	-	7,5	0,5	-	1,2	-	3,2	4,5	-	6,0	0,4	-	1,1	-	3,0	3,7	4,5	6,0
max. fault time [s] – * with 30% of fault current as continuous load																				

Industries



Automation & drives



Transport & logistics



Power generation



Plant engineering

Worlds
earth

NER up to 36 kV

available equipment combined with option box (type A2+B+C)

- Vacuum Breaker
- Current Transformer and / or Voltage Transformer
- Thermostat

Voltage	25 kV						33 kV						36 kV					
	A2		B		C		A2		B		C		A2		B		C	
Width	1270 mm	1470 mm	1270 mm	1470 mm	1270 mm	1470 mm	1270 mm	1470 mm	1270 mm	1470 mm	1270 mm	1470 mm	1270 mm	1470 mm	1270 mm	1470 mm	1270 mm	1470 mm
fault current [s]																		
5 A*	45	-	-	-	-	-	24	47	-	-	-	-	11	47	-	-	-	-
10 A*	25	42	-	-	-	-	15	26	60	-	-	-	8,0	15	40	-	-	-
15 A*	17	-	50	-	-	-	5,0	10	40	-	-	-	2,0	10	26	38	-	-
20 A*	9,0	14	30	-	-	-	-	4,0	20	25	40	-	-	4,0	20	-	30	-
30 A*	2,0	-	20	-	30	-	-	-	-	-	20	25	-	-	5,0	10	18	25
40 A	10	13	20	27	40	-	8,0	-	19	-	27	65	8,0	-	19	-	20	60
100 A	7,5	11	20	37	-	-	2,0	8,0	11	21	23	44	2,9	8,5	13	18	23	40
200 A	5,5	6,5	13	18	19	40	3,5	4,5	10	14	-	30	3,0	4,7	7,4	9,0	13	19
400 A	3,2	-	9,0	13	-	24	2,3	-	4,6	10	11	19	2,3	-	4,5	-	9,5	14
800 A	2,3	-	6,0	10	-	14	1,2	-	3,3	6,5	-	12	1,2	-	3,3	-	6,0	11
1000 A	1,8	-	4,5	8,0	9,0	12	1,3	-	3,4	6,0	6,5	9,0	1,5	-	2,5	-	6,0	9,0
2000 A	1,0	-	2,5	3,6	-	5,5	0,7	-	2,2	3,2	3,0	4,8	0,7	-	1,2	-	3,0	3,8
max. fault time [s] – * with 30% of fault current as continuous load																		

Type A1

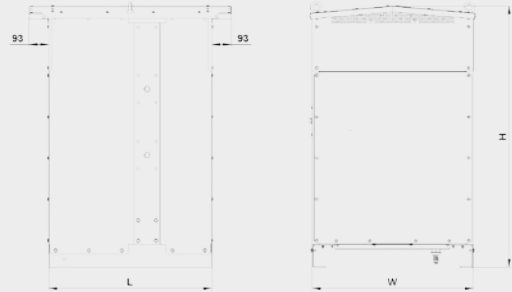

Type A2+B+C

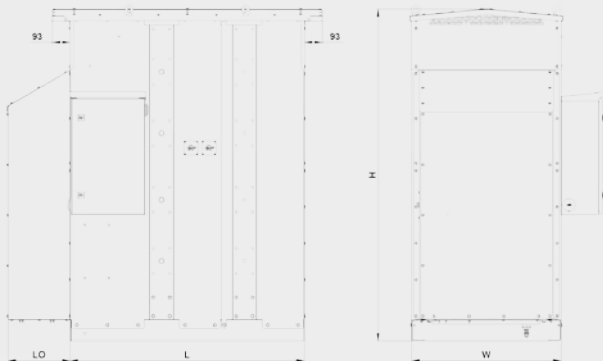

Size				
A1	up to 12 kV	L: 720 mm		H: 1260 mm
A1	up to 24 kV	L: 1080 mm		H: 1410 mm
A2	up to 12 kV	L: 780 mm	LO: 320 mm	H: 1720 mm
A2	up to 24 kV	L: 1080 mm	LO: 410 mm	H: 1920 mm
A2	up to 36 kV	L: 1380 mm	LO: 500 mm	H: 2220 mm
B	up to 12 kV	L: 1210 mm	LO: 320 mm	H: 1720 mm
B	up to 24 kV	L: 1530 mm	LO: 410 mm	H: 1920 mm
B	up to 36 kV	L: 1880 mm	LO: 500 mm	H: 2220 mm
C	up to 12 kV	L: 1540 mm	LO: 320 mm	H: 1720 mm
C	up to 24 kV	L: 1920 mm	LO: 410 mm	H: 1920 mm
C	up to 36 kV	L: 2280 mm	LO: 500 mm	H: 2220 mm

Industries



Automation & drives



Transport & logistics



Power generation



Plant engineering

Worlds
earth

Temperature monitoring device

When designing driving and braking systems for railway applications, the safety of the passengers has top priority. The “**protection device for temperature monitoring and self-diagnosis – STS**” is a major step toward improving safety. When the temperature of the brake resistor exceeds a defined maximum value, the system sends an immediate warning signal to the traction control system of the train.

The device determines the temperature of the resistor at a local hot zone based on the heat increase of the resistance value of two different materials. The electrical potentials on the materials are measured by two sensors. From these two voltages, a quotient that behaves proportionally to the temperature of the active elements is generated.

The measuring data is transmitted without potential to an evaluation unit that is located inside the stainless steel casing. Using the stored material characteristics, the temperature is calculated, and the values are compared

with the given maximum temperature. If this temperature is exceeded, a signal for the drive control or a warning signal is generated. The evaluation unit can be mounted at any location outside of the resistor.

The protection device is designed for highly dynamic brake and load cycles of self- and forced-cooled brake resistors. It works absolutely inertia-free and is most suitable for thermal monitoring. The protection device from HEINE Resistors GmbH is patented.



Performance data

Protection degree	IP 54
Minimum switching on time of DC voltage	80 μ s
Temperature range	up to 900 °C
Dynamical durability	Shock and shake test according DIN EN 61373
Output signal (digital)	potential free switch (logical: 0 and 1)

Block diagram

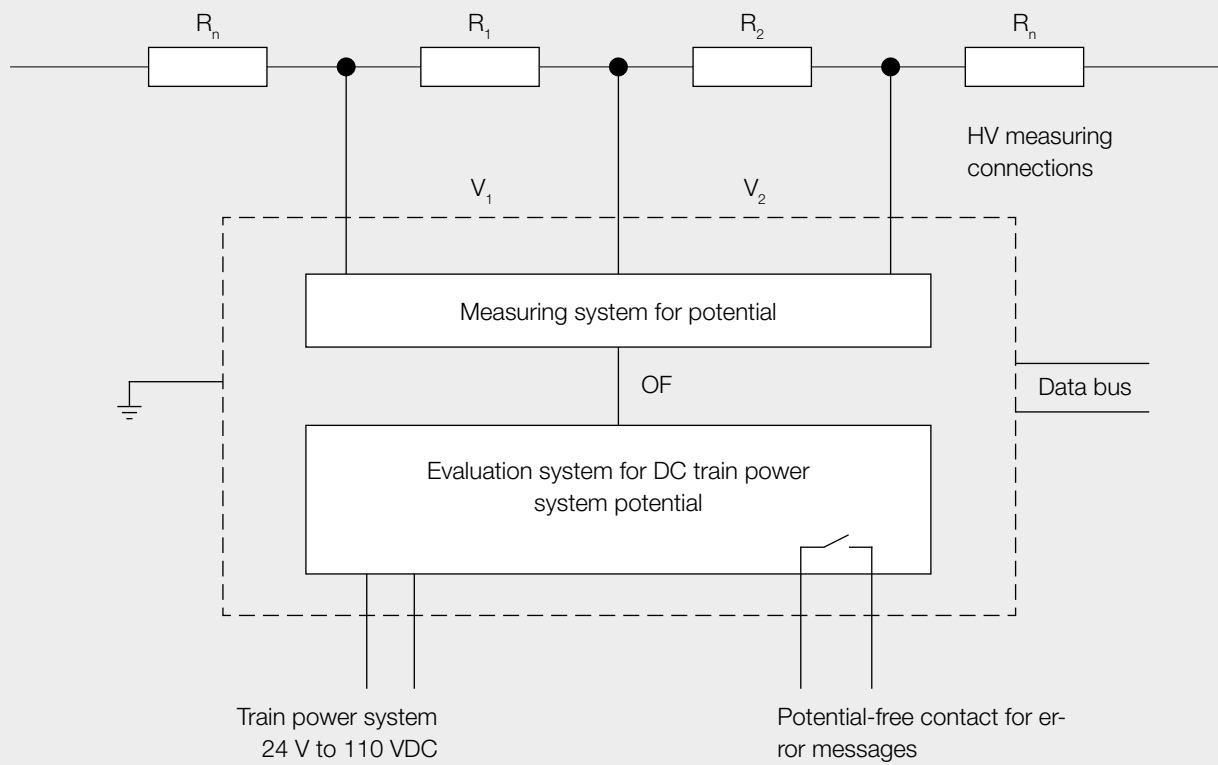

- R_n Part of the braking resistor
- R_1 Monitored part of the resistors (some single elements – hot spot)
- R_2 Reference material
- OF Optical fibre
- HV High voltage

Certification

Certified quality

Certificates attest to the high quality of our products. The fact that we have earned the ISO 9001 quality management accreditation shows our desire to continuously increase customer satisfaction. In addition, we were also awarded the ISO 14001 international environmental management standard in 2004.

The IRIS (International Railway Industry Standard) certificate allows us to comply with the international quality management systems of railway manufacturers and suppliers of equipment components and means that we are ideally equipped for new orders from the global railway market with products such as the band resistor.







HEINE Resistors GmbH

Otto-Mohr-Straße 5
01237 Dresden · Germany

Phone: +49 351 3192-0

Fax: +49 351 3192-119

Mail: info@heine-resistors.com

www.heine-resistors.com

